



Maui Electric Company, Ltd.
Curtailment Reduction Plan Impact Study
June 30, 2014

John D.L. Hieb
James W. Cote, Jr. Ph.D., P.E.
David W. Burlingame, P.E.

Summary of Changes

<i>Revision</i>	<i>Revision Date</i>	<i>Revision Description</i>
0	April 8, 2014	Initial Release
1	June 30, 2014	Revised based on comments from MECO

Table of Contents

1	Executive Summary.....	1
2	Introduction	4
3	Model Benchmark	4
4	Model Update for Future Cases.....	8
4.1	Auwahi Wind Farm Battery Model	10
5	Ramp Rate Adequacy	11
6	Base Case and Assumptions.....	13
7	Steady-State Power Flow Analysis and Results	18
7.1	Line Overloads	18
7.2	Bus Voltage Violations.....	19
8	Transient Stability Analysis and Results	20
8.1	Transient Stability Results	21
8.2	BESS Sensitivity Cases.....	26
8.2.1	BESS Sensitivity – Unit Trip Results	26
8.2.2	BESS Sensitivity – Line Fault Results	31
8.3	Instability Sensitivity Cases	35
8.3.1	Pilot Protection	35
8.3.2	Extended Ride-Through for PV	37
8.3.3	Increasing Number of Circuits on UFLS	39
8.3.4	Combined Sensitivity Cases.....	40
9	Critical Clearing Times	44
9.1	PV Tripping Prevention Analysis.....	44
9.2	Loss of Synchronism Analysis	46
10	Short Circuit Current Impacts	52
11	Protection Review	54
12	Conclusions and Recommendations	55

Table of Figures

Figure 3-1:	AWF Trip System Frequency Response	5
Figure 3-2:	Frequency Response to Loss of M16 Turbine.....	6
Figure 3-3:	M16 Trip Response, and M14 Unit Response.....	7
Figure 4-1:	2019 Preferred Transmission Upgrade One-Line	9
Figure 4-2:	KPP Retirement Line Upgrade Data.....	10
Figure 5-1:	Cumulative Intermittent Generation Ramps With 128 MW PV Capacity	12
Figure 8-1:	System Collapse for Maalaea - Lahaluna Line Fault	25
Figure 8-2:	BESS Sensitivity Results for 2014 KWP Trip	28
Figure 8-3:	BESS Sensitivity Results for 2019 M14 Trip.....	29
Figure 9-1:	Maalaea 1 Rotor Angle for Various Clearing Times.....	49
Figure 9-2:	Waena 1 Rotor Angle for Various Clearing Times	50

Table of Tables

Table 5-1: Daytime Dispatch with 128 MW DG Capacity.....	13
Table 6-1: Load Levels.....	13
Table 6-2: PV Generation Levels	15
Table 6-3: 2014 Dispatch Cases	15
Table 6-4: 2016 Dispatch Cases	16
Table 6-5: 2019 Dispatch Cases	17
Table 6-6: PV Trip Settings	18
Table 7-1: Line Overload Contingency Results	18
Table 7-2: REG 23 kV Bus Voltage for Contingencies with 2019_p_wnd Dispatch	20
Table 8-1: Transient Stability Simulations	21
Table 8-2: UFLS Stages for Unit Trip Simulations	21
Table 8-3: Expected Clearing Times	22
Table 8-4: Line Fault Results - Current Protection System	23
Table 8-5: Line Fault Results – No Comms / Comms Failure	24
Table 8-6: BESS Availability.....	26
Table 8-7: BESS Sensitivity - Number of UFLS Stages Shed.....	27
Table 8-8: Alternate Dispatch Scenarios	30
Table 8-9: Unit Outage Dispatch Sensitivity Results	30
Table 8-10: Fault Instability Results 1 of 3.....	31
Table 8-11: Fault Instability Results 2 of 3.....	32
Table 8-12: Fault Instability Results 3 of 3.....	34
Table 8-13: Unstable Cases with Pilot Protection.....	36
Table 8-14: Unstable Simulations with Extended Ride-Through for PV	38
Table 8-15: Simulation Results with Additional Circuits on UFLS	39
Table 8-16: KWP Trip Comparison.....	40
Table 8-17: Simulation Results with UFLS Change and Extended Ride-Through (Unit Trips) ...	41
Table 8-18: Simulation Results with UFLS Change and Extended Ride-Through (Line Faults) ..	42
Table 8-19: Simulation Results with Pilot Protection, UFLS Change, and Extended Ride-Through	43
Table 9-1: Critical Clearing Times	44
Table 9-2: Critical Clearing Time for PV Tripping Prevention Table 1 of 2	45
Table 9-3: Critical Clearing Time for PV Tripping Prevention Table 2 of 2	46
Table 9-4: Critical Clearing Time for 2016_p_clm Dispatch Case.....	47
Table 9-5: Critical Clearing Time for 2019_dp_clm_cld Dispatch Case	47
Table 9-6: Critical Clearing Time for 2019_dp_clm_cld Dispatch Case Alt. Transmission	48
Table 9-7: Critical Clearing Time for 2019_p_clm Dispatch Case.....	48
Table 9-8: Critical Clearing Time for 2019_p_clm Dispatch Case Alternate Configuration.....	50
Table 9-9: Critical Clearing Time for 2019_p_wnd Dispatch Case.....	51
Table 9-10: Critical Clearing Time for 2019_p_wnd Dispatch Case Alternate Configuration.....	51
Table 9-11: Critical Clearing Time for Waena Synchronism – Inertia Sensitivity	52
Table 10-1: Composite Short Circuit Results.....	53
Table 10-2: N-1 Available Fault Current and SCR 1 of 2	53
Table 10-3: N-1 Available Fault Current and SCR 2 of 2	54

1 Executive Summary

MECO is planning to make significant changes to their system in order to increase the system flexibility, decrease curtailed renewable energy and maintain reliability. MECO is planning on retiring the Kahului Power Plant (KPP), replacing the capacity with flexible, fast-ramping, quick startup units at the Waena Power Plant. In addition to the generation replacements, MECO will be making several transmission system upgrades to compensate for the KPP retirement's effect on the 23 kV voltage support. Overall, the system changes are intended improve the system's ability to accept more renewable energy.

MECO provided proposed generation scenarios for years 2014, 2016 and 2019 corresponding with major changes to the MECO generation fleet. In 2014, the DTCC2 CTs will be modified to allow operation in simple cycle mode. In 2016, DTCC1 minimum operating modes will be reduced. In 2019, the KPP units will be retired. Both a preferred and an alternate transmission configuration were studied for the 2019 study year.

Under MECO's proposed generation plan, the minimum system-wide ramp capability would be 5.0 MW/minute in 2019. MECO's projection of 128 MW of photovoltaic (PV) capacity and 72 MW of wind capacity requires a ramp rate capability of at least 5.5 MW/minute to maintain system frequency. Additional ramping resources such as generation units, energy storage, demand response, or increased usage of the existing battery systems will be required to maintain system frequency during these ramp events.

The Pukalani 23 kV feeder requires additional voltage control resources or changes to the tap changer controls to properly maintain the voltage along the entire circuit length with the high levels of expected PV generation in 2019. The current voltage regulation resources are unable to regulate the voltage. Additional voltage support resources such as capacitors, Statcoms, or other devices or tap changer control changes are required during peak loading conditions in study year 2019.

The alternate 2019 transmission configuration resulted in the Kihei 69 kV bus voltage dropping below 0.90 per unit voltage at peak conditions with the loss of the Maalaea – Kihei line. Additional VAR resources such as capacitors, Statcoms, or other devices are required to support the voltage at Kihei in the alternative configuration.

The loss of PV generation due to low voltage during a transmission fault, under frequency following a unit trip, or over frequency following a transmission fault results in a severe loss of generation on the MECO system. The system will subsequently experience a severe loss of load due to under frequency load shedding and in many simulations does not survive the contingency.

Upgrading transmission protection to use high-speed communications aided tripping on all 69 kV transmission lines, increasing the number of circuits on UFLS, and forcing new PV to use extended ride-through settings were all evaluated as system improvements to prevent system collapse. Individually, none of the three system improvements could prevent system collapse. Collectively, when all three system improvements are taken together, the system will survive each contingency studied for each dispatch case. However, this survival in part is dependent on the control of the PV converters behaving exactly as modeled. In simulations, all converters were expected to ride through the events with the increased voltage and frequency settings.

With the large amount of projected PV growth on the island, the tripping of the PV becomes the dominant contingency for MECO, approximately 6 times larger than the existing largest contingency. The loss of all Rule 14H compliant PV can lead to system collapse during or following a single contingency event. The only practical method of ensuring the system

survives these events is to prevent the PV from tripping with significant system improvements or changes in Rule 14H characteristics, including the legacy installations of PV. Even with 4 cycle clearing for a 69 kV fault, the system frequency exceeds the 60.5 Hz trip setting of the PV for the 2019 daytime peak cases, which leads to a system collapse. EPS recommends a comprehensive UFLS study be conducted that considers the loss of the PV generation as well as the loss of conventional generation. The study should also look at the issues associated with reduced net load on each stage of the UFLS design, due to PV increases at the feeder level.

The consequences of an over shedding of load by the UFLS system are severe. Shedding too much load following the loss of a generation unit results in the loss of all Rule 14H compliant PV and the collapse of the system.

The availability of battery frequency support has a significant impact on the number of stages of load shed needed to arrest system frequency decay. Without battery support, the loss of a single conventional generation unit coupled with the loss of legacy PV can cause system collapse. With current levels of battery support the system remains stable.

Faults near the proposed new units at the Waena Power Plant can cause the Waena units to lose synchronism with the rest of the system. The loss of these units severely impact the system and potentially lead to system collapse. Synchronism could be maintained if the fault was cleared in 9 cycles at the near end and 12 cycles at the far end. We recommend that MECO make improvements to the protection to ensure acceptable clearing times and/or consider units with greater inertia for the Waena Power Plant.

The available fault current for the minimum generation configuration in year 2019 is sufficient for wind farm operation at all three plants.

For the protection of the system, EPS recommends that Rule 14H be modified to provide ride-through requirements similar to MECO's thermal generation. The performance of the control systems of Rule 14H generation are critical to the security of the system. Data provided by MECO for actual system events indicate that some PV installations installed following the previous modifications to Rule 14H continued to trip off-line at 59.3 Hz. As such, MECO should consider annual testing of all or a portion of Rule 14H control systems. The results of the annual test should be incorporated into MECO's transient stability model.

While system needs require an expanded ride-through capability of all distributed generation, this requirement must be balanced against the need for protection of individual feeders or substations. Expansion of the Rule 14H requirements may result in a lower allowable penetration level on each feeder to ensure adequate feeder protection following isolation. We recommend the high voltage settings in Rule 14H remain sensitive to provide protection against high voltages following isolation of distribution feeders, with expanded settings on under voltage and over/under frequency.

As the system changes to a lighter inertia system and security margins decrease, the importance of the response of individual units and their models in the transient stability program dramatically increase. We recommend MECO tune the response of each of their generators and AGC and reflect these new response characteristics in the PSS/e model for the system.

As the system inertia decreases, the critical fault clearing times will continue to decrease. We recommend MECO install high-speed communications and relaying on all transmission lines in the system to ensure operation and fault clearing within 5 cycles. We recommend all transmission protection utilize dual-redundant relaying and communication lines to ensure failed relaying protection does not result in delayed clearing and system collapse.

The existing UFLS system should be reviewed for adequacy. The system utilizes only 25% of the MECO load for all stages and does not arrest frequency decay for large contingencies. The system should be revised to control 55-65% of the MECO load and be designed to survive large contingencies on the MECO system.

2 Introduction

Maui Electric Company Ltd. (MECO) contracted with Electric Power Systems, Inc. (EPS) to perform an impact study (study) for their curtailment reduction plan. The primary focus of this study is to identify the system impacts of the curtailment reduction plan with regard to system steady state bus voltage and line flow, transient stability, minimum fault current conditions, and ramp rate adequacy. The study used two transient events that occurred on the MECO system to benchmark, and where necessary, change the transient stability model to better replicate actual system events.

The study addressed the transient stability of the future generation dispatch scenarios. The study also reviewed the existing under-frequency load shedding scheme, and its performance with significant increases in the amount of distributed generation (DG) on the MECO system. The Auwahi Wind Farm (AWF) model was updated to a custom model that will more closely represent the wind farm system as specified in the Power Purchase Agreement (PPA).

The future PV was added to the MECO system to correspond to the same distribution as the existing PV. A custom model was developed to allow each PV generator to trip with specified under frequency, over frequency, and under voltage settings.

3 Model Benchmark

EPS used two system events from 2013 to benchmark the MECO model in preparation for the study. Considering MECO is planning to reduce the number of units online, the modeled accuracy of the units is more important than historical requirements for accurately simulating the system response.

MECO provided recordings from Maalaea and Kahului power plants, SCADA recordings, and event reports for two unit trip events. The first event was a trip event of the M16 and M18 units that occurred on August 22, 2013 that included high-speed recordings of the latter part of the event. The second event was a trip of the Auwahi Wind Farm (AWF) on January 25, 2013 which did not have any high-speed recordings available.

The focus of the model benchmark process is to provide an updated model that more accurately reflects the performance of the system immediately following transient events. This focus is important since the system response of interest occurs in the first few seconds following an event, and long-term grid interactions such as AGC and steam turbine bleed-off are not as important in determining transient stability.

The Auwahi trip event, and the M16/M18 events were evaluated independently. The two benchmark result plots are included in Appendix A, and show the recorded individual unit response plotted against the simulated response of both the EPS updated model and the original model. Shown below is the system frequency response for the Auwahi wind trip.

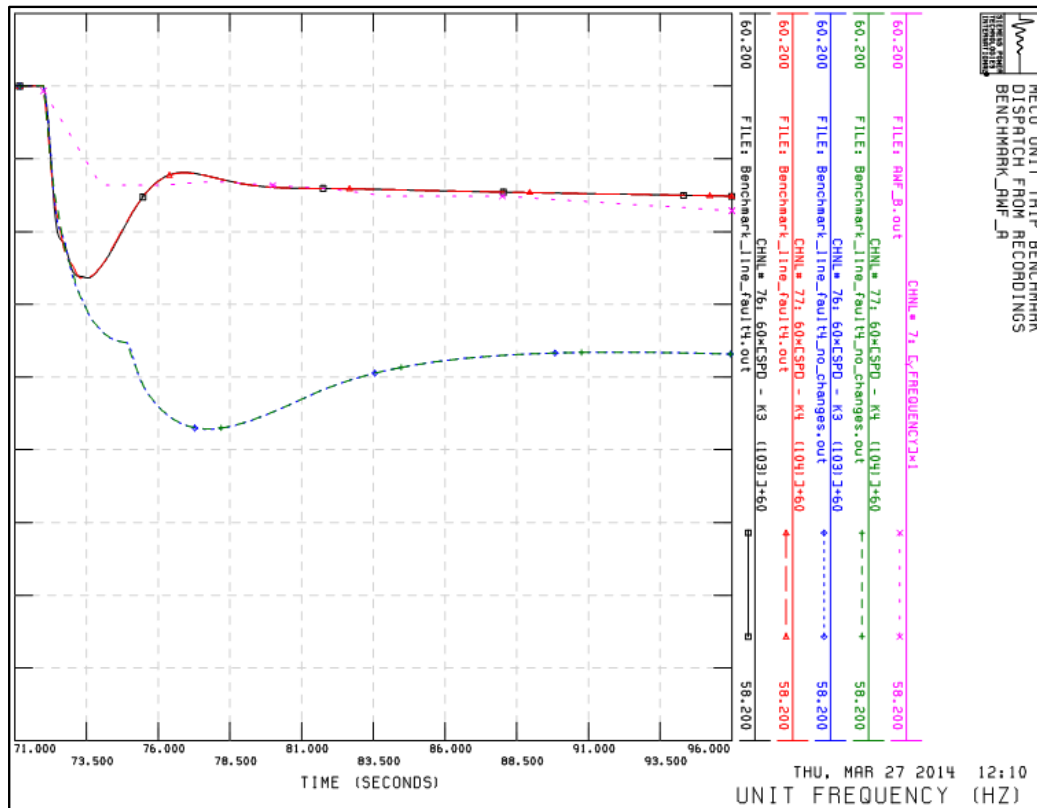

Figure 3-1: AWF Trip System Frequency Response

Figure 3-1 shows the system frequency for the EPS simulation (red), the original database simulation (blue) and the recorded system frequency (pink). The recommended model's simulated settling frequency is very close to the recorded settling frequency, but is much lower transiently. The simulation indicates the limitations of using SCADA samples to establish the apparent system frequency nadir. The original model resulted in the loss of PV generation at 59.3 Hz, and did not respond quickly enough to the change in system frequency. The model changes necessary to get the frequency response shown in the EPS simulation above are as follows:

- Unit capacity limits were set based on SCADA recordings
- K3, K4, and HC&S droop settings (1/droop) were updated from (1, 1, 25, respectively) to (12, 16, 6, respectively) which significantly increased the response from K3 and K4 but reduced the response from HC&S so that these units more closely match the recorded unit responses
- M10-M13 droop settings were set to 4% with the T1 time constants updated to 1.5 seconds. M13 was less responsive in the simulation than recorded, but increasing the response of this unit any further would have caused the overall system frequency recovery to be in error.
- The LM2500 models for the M14, M16, M17, M19 were updated with the following settings to speed up initial response times as seen in recordings.
 - Droop = 0.04
 - KIP = 0.3
 - KP = 0.675

- KI = 2.1
- SDR = 1000 (disabled)
- TCD2 = 0.0
- The HRSG time constants were changed to 240 seconds to more closely model the unit ramp down in response to the loss of a feeder unit
- The load frequency dependence was removed
- M5 – M9 unit governors were disabled by setting droop to 999 because they did not move

All EPS simulated unit responses were compared against the recordings and the original database simulation results. The plots of these results are attached to this report.

The system response to the M16 unit trip event is shown below in Figure 3-2.

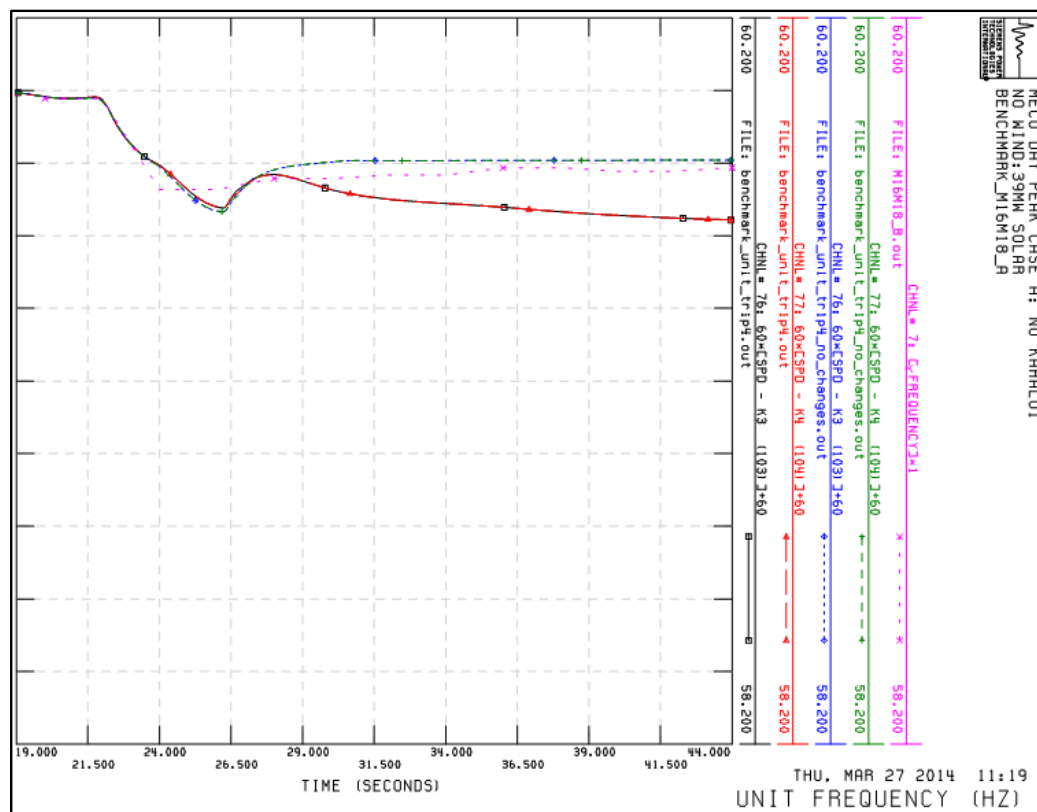

Figure 3-2: Frequency Response to Loss of M16 Turbine

The initial frequency response is fairly close between the three plots, but the simulated frequency (red/black) is lower at the end of the simulation than the recorded frequency (pink). The original database was close to matching the actual recording, but this is due to the erroneous contribution from the M4, M8, and HC&S units in that simulation. These units provided very little response in the actual event but provided a significant response in the original model. Setting up this system response was more difficult due to the type of system disturbance. High speed recordings of the event were not available, when a simulated instantaneous unit breaker trip at full output the system frequency decay was more rapid than indicated by the SCADA recordings. Based on the SCADA recordings, it appears the unit

experienced a “soft” trip as opposed to a trip of the unit under full load. A soft trip indicates the turbine was tripped or rapidly reduced its output, and the unit breaker didn’t open until the unit went into a reverse power condition. The response of the M14 unit also increased the difficulty of using this event for a benchmark case. This unit initially increased its output in the first few seconds after the event as expected, but reduced its output back to the initial set point 25 seconds after the initial event. Figure 3-3 shows the unit trip response, and the M14 response compared to the SCADA recordings.

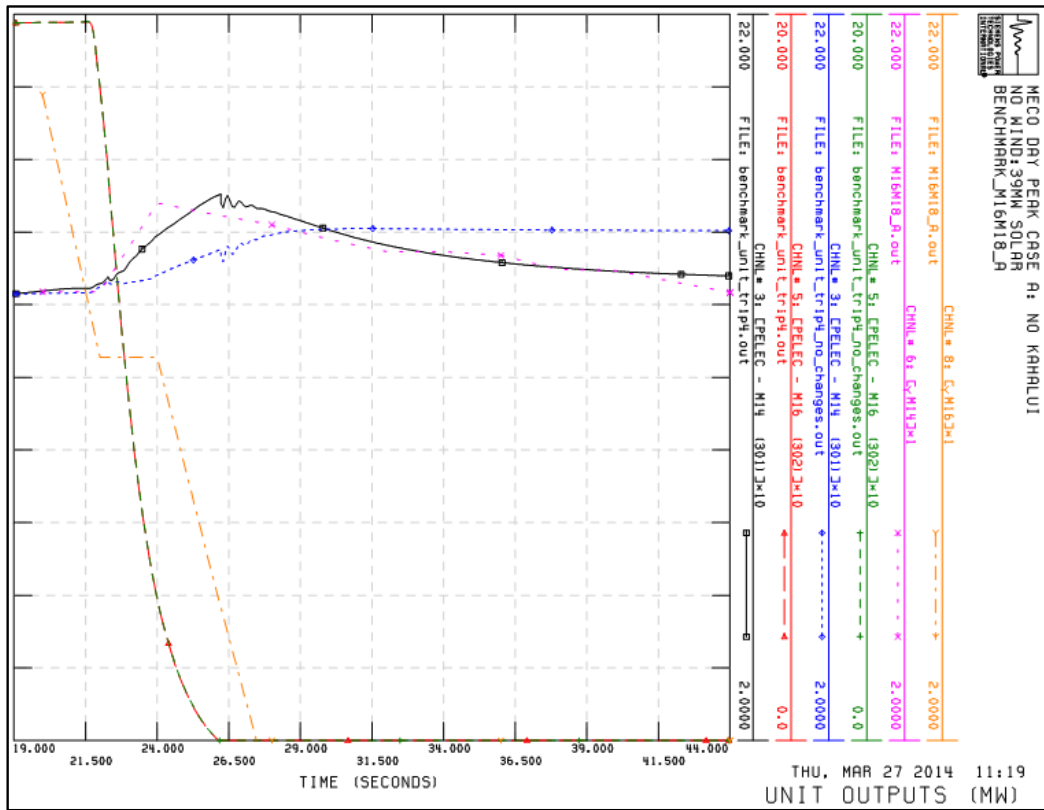

Figure 3-3: M16 Trip Response, and M14 Unit Response

The recorded output of the M16 unit and the simulated output are shown in orange and blue/red respectively. The black (EPS simulated), blue (original database), and pink (recorded) traces show the M14 response to the event. This event appears to be influenced by control action outside of the unit governor included in the PSS/E model.

We were able to approximate the M14 ramp down by setting the PSS/E pressure limit such that any increase in the M14 unit output would exceed the pressure limit. The pressure limit control would reduce the unit output to near the initial power set point. The M14 recorded response (pink) and the simulated response (black) show similar responses to the unit trip event. MECO indicated that plant technicians have recordings indicating AGC will pulse the units down during low frequency events. In order to mitigate the AGC error the M14 and all gas turbines will disable AGC during low frequency events.

The system had sufficient reserves to restore frequency to 60 Hz following the unit trip, but the reserves were not utilized by the AGC system. As per discussion with MECO, the plant operators had limited unit M14 to 14 MW.

The M16 event benchmark had the same simulation settings as the AWF trip event with the following exceptions:

- Pressure control modifications to M14 to simulate AGC ramp down
- Droop settings (1/droop) at K3, K4, and HC&S were changed to 4, 6, 0.1 from 12, 16, 6

Based on the results of the simulations, we assume that the steam turbines would respond with the more aggressive droop settings. We also assumed the following changes to the MECO database based on the benchmark process. The following changes were incorporated into the transient stability model used for the transient stability analysis.

- M10-M13 droop settings were set to 4% with the T1 time constants updated to 1.5 seconds.
- The LM2500 models for the M14, M16, M17, and M19 were updated with the following settings to speed up initial response times as seen in recordings.
 - Droop = 4%
 - KIP = 0.3
 - KP = 0.675
 - KI = 2.1
 - SDR = 1000 (disabled)
 - TCD2 = 0.0
- The heat recovery steam generator (HRSG) time constants were changed to 240 seconds
- The load frequency dependence was removed
- M5 – M9 unit governors were disabled by setting droop to 999
- The AGC system will be fixed to prevent the response seen from the M14 unit during the August 22, 2013 event

The result of the benchmarking effort was a transient stability database that more accurately reproduces the actual system response to disturbances. The original PSSE database for the MECO system did not accurately reproduce the actual system response to the two benchmarked events. We recommend that additional system transient recordings be captured from actual disturbances and that PSS/e simulations be checked against the recordings. When PSSE does not reproduce the important unit and system responses in the transient time frame, the PSS/e dynamic models should be revised.

The response of the AGC system during transient events will become more critical as the system's inertia and on-line dispatchable generation decreases. We recommend the AGC and generator interaction be tuned to ensure that AGC control always restores frequency to 60 Hz and does not exhibit any negative control.

4 Model Update for Future Cases

Two transmission upgrade plans were used in this study. The upgrades associated with the preferred upgrade plan include:

- Kanaha – Waiinu 23 kV line upgrade to 69 kV
- Maalaea – Waiinu 69 kV line conductor upgraded from 336 to 556

- Maalaea – Puunene 69 kV line conductor upgraded from 336 to 556
- Puunene – Kanaha 69 kV line conductor upgraded from 336 to 556
- Kamalii substation is added
- Maalaea – Kamalii 69 kV line is added
- Kihei – Wailea 69 kV line is routed through the Kamalii substation

Figure 4-1 shows the preferred transmission upgrade plan.

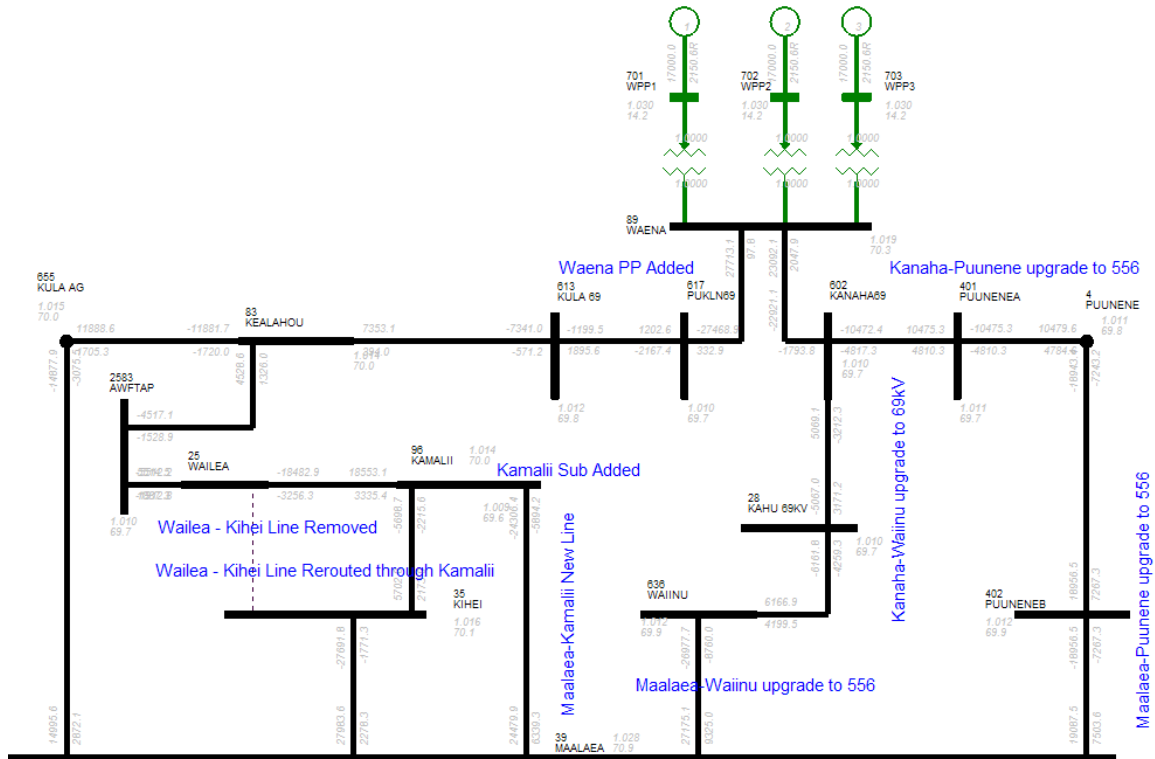

Figure 4-1: 2019 Preferred Transmission Upgrade One-Line

An alternate 2019 transmission upgrade plan was studied. For this configuration we implemented several model changes according to data provided by MECO regarding the Kanaha – Waiinu transmission line upgrade, and the Kahului Power Plant retirement transmission upgrades.

The Kanaha – Waiinu line was upgraded from 23 kV to 69 kV. Two 20 MVA transformers were added to the database that connected the 69 kV bus at the Kahului substation (substation 8) to the existing switchgear. The 23 kV lines from Kanaha and Waiinu were replaced with 69 kV line sections, and the load at Onehee (sub 40) was fed off the Kahului 23 kV switchgear.

The KPP transmission upgrades included new lines from MPP to Waiinu, MPP to Puunene, and Kanaha to Puunene. Line impedances were provided by MECO and are shown below in Figure 4-2.

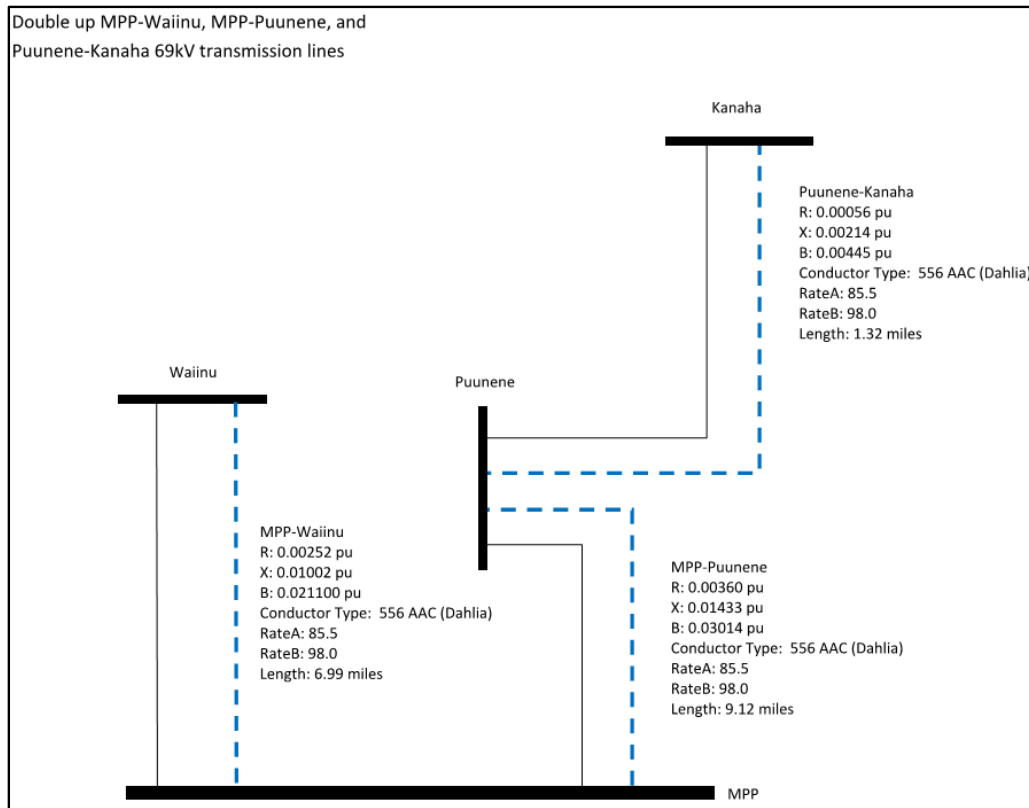

Figure 4-2: KPP Retirement Line Upgrade Data

Using databases provide by MECO as a template, the Waena Power Plant (WPP) was added to the 2019 database. The 69 kV bus was placed at the midpoint of the Kanaha – Pukalani line. Three generators and step-up transformers were added. The generators were setup to control the 69 kV bus voltage to approximately 1.03 per-unit voltage. The transformers were setup with a 1:1 tap ratio, and were copied from the Puunene 20 MVA transformer.

The dynamic models for the WPP units were obtained from the database of another EPS client that is installing 17 MW Wartsila units. These models are for the Wartsila 18V46 units that MECO has proposed.

4.1 Auwahi Wind Farm Battery Model

The developer has not provided a PSS/E model that includes an inertial and droop response for both the wind turbine generator (WTG) and the BES. EPS created a battery model that will approximate the AWF plant response to system frequency events or wind farm ramp events. Without explicit operating diagrams or description of the system controls, our model may not accurately represent the response of the control system. This model should be updated when actual documentation or a PSS/e model is received from the IPP. The model has the following controls:

- 4% droop response for frequencies between 59.9 Hz – 59.8 Hz (when wind power is available) and 60.1 – 60.2 Hz
- 2% droop response for frequencies below 59.8 Hz (when wind power is available) and for frequencies above 60.2 Hz

- An inertial response based on the GE WindInertia™ controls to mimick the response of a unit with an inertia constant of 6 seconds. (We do not know the specifics of how the Siemens controls will work, so we used the GE control strategy as a best approximation)
- A ramp rate control for the power ramp rate out of the wind farm
- No voltage control

We assumed the AWF wind farm plant control will use the combination of the wind farm and the battery to accomplish the specific performance criteria laid out in the PPA. However, the current MECO PSS/e model does not include any “smart” controls. We implemented the plant-wide controls into the battery model. Our major assumptions include:

- When frequency is below 60.0 Hz, the battery system will respond by adding the power required for ramp rate control to the larger of the droop or inertia controls
 - If $f < 60$, $P_{\text{output}} = P_{\text{ramp}} + \text{Maximum}(P_{\text{droop}}, P_{\text{inertia}})$
- When frequency is above 60.0 Hz, the battery system will respond by adding the power required for ramp rate control to the smaller of the droop or inertia controls
 - If $f < 60$, $P_{\text{output}} = P_{\text{ramp}} + \text{Minimum}(P_{\text{droop}}, P_{\text{inertia}})$
- The battery is current limited when the voltage is below 0.7 pu voltage.
- The battery system is limited to 11 MW
- The battery system will try to maintain the MVAR setpoint at which it is initialized, but the power output priority is higher than the reactive power priority

Poutput is defined as the desired power out of the battery inverter. Pramp is the portion of the total desired power out of the battery inverter to maintain the ramp rate limits required in the PPA. Pdroop is the portion of the total desired power out of the battery inverter from the droop controls. Pinertia is the portion of the total desired power out of the battery inverter from the simulated inertia controls.

It is important to note that this battery model should only be used as a stop-gap measure since the developers have not provided a transient stability model that properly replicates the actual control system, and the developer has not provided detailed control block diagrams and descriptions of operation. This model was created for use during this project, and has some limitations, particularly with regard to the voltage control. In the absence of a proper model from the developers, we believe it can serve as an interim model for the power control features of the Auwahi wind farm.

5 Ramp Rate Adequacy

In order to determine whether the future generation configurations will have adequate ramp rate capabilities with additional renewable capacity and fewer units online, we analyzed six months of solar and wind data provided by MECO during a previous project. The data was created as part of the Hawaii Solar Integration Study (HSIS) and was provided to EPS in two pieces. The first piece included six months of SCADA data with the wind power output for each of the three wind plants. The second piece of data was an island-wide solar time series based on a 15 MW capacity. We scaled this data to get an approximation of the ramping needs in 2019 when the system has 128 MW of solar capacity. The wind and solar data were summed together to get

the total as-available generation. The 30-second and 60-second change in power output were calculated and sorted to get the total number of ramps in a 6-month period.

Frequency regulation is generally considered to be a sub-minute system constraint. Therefore, the 30-second net demand ramp is likely the best ramp to use when determining the regulation requirements. Figure 5-1 shows the cumulative ramp rates for the 30-second and 60-second ramp. The 30-second ramp is approximately 5.5 MW or less for 99.9% of the approximately 8 million samples. This ramp rate analysis does not consider the ramp rate requirements for changes in system load which would serve to increase the generation fleet ramp rate requirement although the system load ramps during daylight hours will be neither large nor fast. These ramp rates already include the use of the two battery systems at KWP2 and AWF which limit the net ramp rate of those facilities.

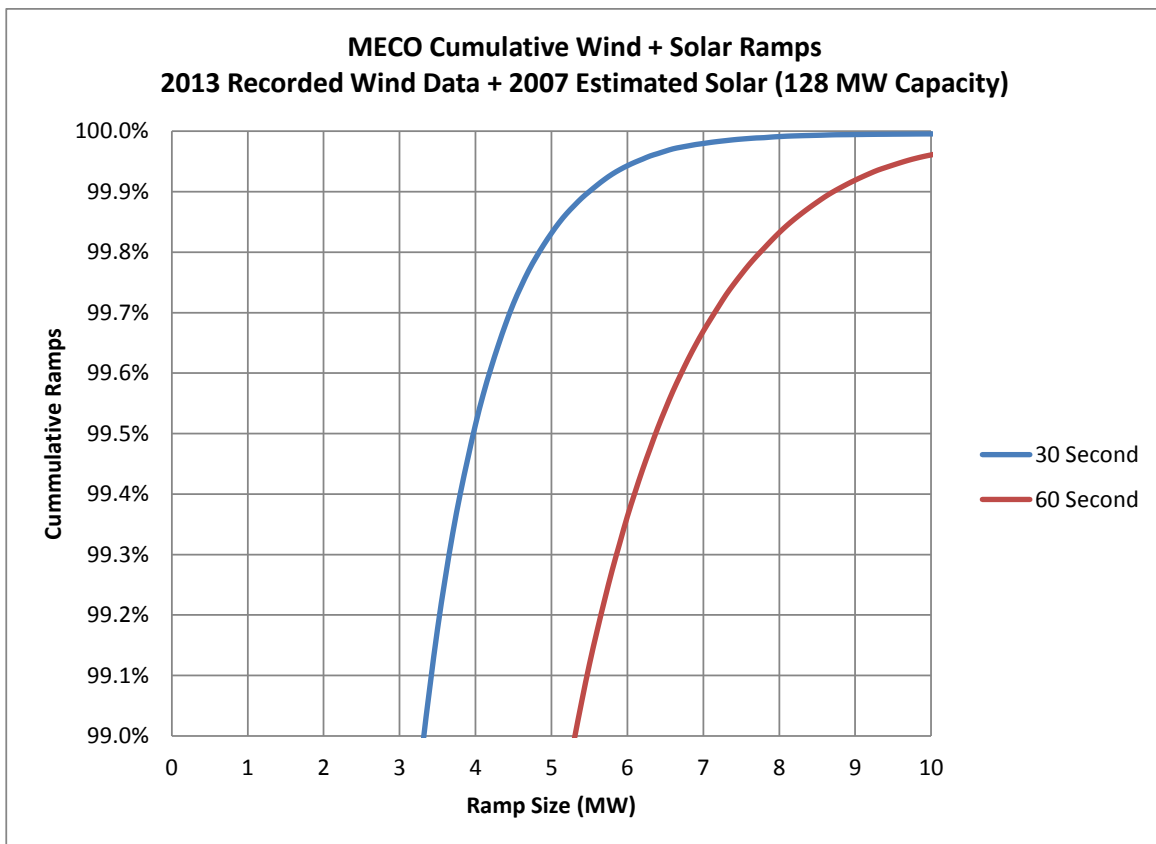

Figure 5-1: Cumulative Intermittent Generation Ramps With 128 MW PV Capacity

It would be difficult for MECO to meet the ramping requirements with forecasted daytime system loading. For example, with a daytime system peak load of approximately 210 MW served by 150 MW of wind and solar generation (renewable generation could exceed 180 MW in the maximum case) and only 60 MW of conventional generation. The conventional generation would need ramping capabilities of 5.5 MW/minute to maintain frequency reliability. Replacing the slower steam turbines with internal combustion engines and/or turbines, the MECO generation fleet could meet this ramp rate.

However, the daytime minimum load period becomes problematic. With a potential solar generation level of 108 MW, and a daytime minimum system load of only 140 MW, the only possible unit configuration based on the curtailment reduction plan is to have DTCC1, and wind

provide the energy. The DTCC1 minimum loading is expected to be 18 MW, leaving only 14 MW of room for the wind generation. The wind generation would be required to cover the maximum downward regulation requirement. The maximum ramping capability of DTCC1 is 5.0 MW/Minute, less than the 5.5 MW/minute ramp rate required. Since Rule 14H generation is not curtailable, it may be necessary for MECO to either curtail all of the wind or have wind provide the required regulation. Regulation services by wind farms are not currently included in the provided PPA's.

Two potential generation dispatches without wind regulation for the daytime peak and daytime minimum are shown in Table 5-1 below with all units expressed in MW.

Table 5-1: Daytime Dispatch with 128 MW DG Capacity

	Unit	MW	Max	Min	Ramp Rate	Reserve
Day Peak	DTCC1	20	53	18	5	33
	M17	13	22	13	2	9
	Waena 1	10	17	8	5	7
	Total	43			12	49
<hr/>						
	Unit	MW	Max	Min	Ramp Rate	Reserve
Day Min	DTCC1	20	53	18	5	33
	Total	20			5	33

The new units at Waena have an expected ramp rate capability of 5 MW/min. This fast ramping capability combined with any other combustion turbine would provide enough ramping capability to meet the regulation requirements. Considering the ramp rate requirements of the future system, MECO may need to consider putting the new Waena units higher in the unit priority (EPS was instructed to use them as peaking units) due to their ramping capabilities.

6 Base Case and Assumptions

EPS created a series of dispatch cases to stress the system for the potential operating scenarios expected for the 2014, 2016, and 2019 years. Four load levels were studied for each year including minimum, daytime minimum, daytime peak, and peak. The daytime peak and peak load levels were taken from the "Ma_2013_2024_GrsPk_summary_adopted.xlsx" file which lists the expected load levels for each year from 2013 to 2024. The peak levels were taken from the incident peak column. The load levels (load levels are actually net generation) are shown below in Table 6-1, in MW.

Table 6-1: Load Levels

Load Level	2014	2016	2019
Minimum	90.0	92.0	95.0
Daytime Minimum	131.0	134.6	138.6
Daytime Peak	192.3	201.4	213.7
Peak	212.0	223.0	236.0

The peak and daytime peak load levels were taken directly from the MECO provided spreadsheet. The daytime minimum and minimum load levels were scaled from the 2014 case to 2016 and 2019 by using the "% Incr" column from the provided spreadsheet.

Each case was setup with the maximum as-available generation possible while obeying the following must-run rules and unit minimum dispatch levels.

2014:

- KPP 1 and KPP 2 are retired and unavailable
- KPP 3 and KPP 4 were treated as must-run units with minimum generation levels of 3.5 MW
- DTCC1 was treated as must run with a minimum generation level of 33 MW
- HC&S is online in all cases with a minimum of 8 MW
- DTCC2 was operated in 1CTCC for low wind cases, and as a simple cycle for high wind cases (if needed for capacity)
- The regulation reserve required was assumed to follow the HSIS regulating reserve recommendation

2016:

- Same as 2014 with the following changes:
 - DTCC1 minimum reduced from 33 MW to 18 MW.

2019:

- Same as 2016 with the following changes:
 - HC&S is removed from the system
 - KPP plant is retired
 - Waena Plant is added – Units used primarily as peaking units, and count ½ capacity toward spinning reserve requirements due to fast start times.

Several dispatches for each year and each load level were evaluated. The minimum and peak cases were assumed to have no DG connected to the system to simulate evening peak and night-time minimum with high and low wind conditions. The daytime cases were created with all combinations of high wind/low wind and high solar/low solar which resulted in 12 dispatch cases for each year. The amount of distributed solar assumed for these cases was taken from the spreadsheet '2013 Fcst MECO Maui Renew Self Gen Charts.xlsx' which lists the projected renewable generation from NEM, SIA, and FIT generation. The 2013 forecast projected total DG at the end of 2013 to be approximately 47.35 MW, but as of 12/11/2013, only 38.03 MW was online. The 9 MW difference was carried through in the 2014, 2016, and 2019 projections. The total DG capacity used in this study for the 2014, 2016, and 2019 years was 47 MW, 94 MW, and 128 MW, respectively.

Due to different aspects, angles, cloud cover, and locations, it was assumed that the actual solar generation would not reach 100% of the installed generation capacity. We used typical solar data to estimate a reasonable island-wide generation level for the daytime hours between 11 A.M. and 2 P.M. The maximum generation expected during those hours is approximately 85% of the installed capacity, while the minimum is approximately 20%. Table 6-2 lists the actual PV generation levels used in the study. Solar generation plants that have 1-axis solar tracking will have significantly better capacity factor, however the majority of the solar being added to the MECO system is fixed solar without the ability to track the sun.

Table 6-2: PV Generation Levels

Year	Capacity	Sunny Day	Cloudy Day
2014	47	40.0	9.4
2016	94	79.9	18.8
2019	128	108.8	25.6

In the dispatch cases that were configured for windy and sunny days, the solar + wind would exceed the daytime minimum load. For these cases, the wind was curtailed until the must-run generation units were dispatched, and the reserve requirements were met. The generation dispatch scenarios used for the 2014 year is shown below in Table 6-3. A spreadsheet showing the actual dispatch levels for each of the power flow cases used is attached in Appendix B.

Table 6-3: 2014 Dispatch Cases

	Minimum		Daytime Minimum				Daytime Peak				Peak	
	Windy	Calm	Windy	Windy	Calm	Calm	Windy	Windy	Calm	Calm	Windy	Calm
Unit			Sunny	Cloudy	Sunny	Cloudy	Sunny	Cloudy	Sunny	Cloudy		
K1												
K2												
K3	3.5	8.0	3.5	3.5	8.5	11.0	9.0	10.0	10.5	11.0	11.0	11.0
K4	3.5	8.0	3.5	3.5	9.0	11.0	9.0	10.0	10.5	12.0	11.5	11.5
M14	13.4	14.4	13.4	14.1	15.0	19.5	15.0	16.6	17.5	20.0	19.5	20.9
M15	8.3	9.8	8.4	9.0	10.0	12.8	9.5	11.5	12.0	13.0	12.8	13.8
M16	13.5	14.5	13.5	14.0	15.0	19.5	15.0	16.5	17.5	20.0	19.5	21.5
M17		16.5			16.0	20.0		13.0	18.5	20.0	17.0	21.0
M18		4.5			4.0	5.0			12.0	13.0	11.5	13.8
M19								16.5	18.5	20.0	17.0	21.0
HCS	8.0	11.5	8.0	8.0	10.0	11.0	9.0	10.0	11.0	11.0	11.0	11.5
M10						9.0	9.5	9.0	11.0	11.3	10.1	11.4
M11									9.4	12.0		12.5
M12							9.0			12.0		12.5
M13												12.0
M4										5.0		5.0
M6												5.0
M8												5.0
KWP1	30.0	2.0	30.0	30.0	2.0	1.0	30.0	30.0	2.0	2.0	30.0	2.0
KWP II1	4.5		4.5	4.5			4.5	4.5			4.5	
KWP II2	6.0		6.0	6.0			6.0	6.0			6.0	
KWP II3				3.0			3.0	3.0			3.0	
KWP II4				7.5		1.0	7.5	7.5			7.5	
Auwahi		1.0		20.0	1.0	1.0	16.0	20.0	1.0	1.0	21.0	1.0
Solar	0.0	0.0	40.0	9.4	40.0	9.4	40.0	9.4	40.0	9.4	0.0	0.0
Load	90.7	90.2	130.75	132.5	130.45	131.2	191.95	193.5	191.35	192.7	212.9	212.4
Req Up	25	6	28	28	25	12.4	28	28	25	12.4	27	6
Up Res	45.8	37.8	45.7	43.9	37.5	18.7	36	39.4	30.6	16.8	27.6	9.4
Ramp	5.3	8.3	5.3	5.3	8.3	9.3	7.3	10.3	12.3	14.3	11.3	17.3

Table 6-3 lists the 2014 dispatch cases. The 'Unit' column lists the generation units, and each cell to the right lists the generation level of that unit for each dispatch scenario. The 'load' row lists the total generation level (including the behind-the-meter solar). The 'Req Up' row lists the required upward reserve as calculated using the HSIS reserve requirements. The 'Up Res' lists the actual regulating reserve online for each dispatch case. Finally, the 'Ramp' row lists the ramp rate capabilities of the online generation mix, in MW/minute. The dispatch cases for the 2016 and 2019 cases are shown below in Table 6-4 and Table 6-5.

Table 6-4: 2016 Dispatch Cases

Unit	Minimum		Daytime Minimum				Daytime Peak				Peak	
	Windy	Calm	Windy Sunny	Windy Cloudy	Calm Sunny	Calm Cloudy	Windy Sunny	Windy Cloudy	Calm Sunny	Calm Cloudy	Windy	Calm
K1												
K2												
K3	3.5	10.0	3.5	7.0	4.3	10.0	5.0	10.0	8.5	10.5	11.0	11.0
K4	3.5	10.0	3.5	7.0	4.3	11.3	5.5	10.0	9.5	11.0	11.5	12.0
M14	8.1	14.5	7.8	9.2	8.0	19.5	10.7	19.7	15.0	21.1	20.0	21.1
M15	3.5	9.8	3.2	6.2	3.1	12.8	8.0	12.7	10.0	13.5	12.8	13.7
M16	8.0	14.5	7.7	9.4	8.0	19.5	10.7	19.7	15.1	21.0	19.5	21.0
M17		16.5			13.0	17.0		13.0	14.3	19.0	17.0	21.0
M18		4.5			3.6	4.0			9.8	12.5	11.5	13.8
M19								17.0	14.3	19.0	17.0	21.0
HCS	8.0	11.5	8.0	9.0	9.0	11.0	10.0	11.0	11.0	11.5	11.0	11.5
M10						10.5			9.5	11.3	10.1	12.0
M11										10.0	11.2	12.5
M12										10.0		12.5
M13										10.0		12.5
M4												5.0
M6												5.0
M8												5.0
M9												5.6
M1												2.5
M2												2.5
KWP1	30.0	2.0	22.8	30.0	2.0	2.0	30.0	30.0	2.0	2.0	30.0	2.0
KWP II1	4.5			4.5			4.5	4.5			4.5	
KWP II2	6.0			6.0			6.0	6.0			6.0	
KWP II3	3.0			3.0			3.0	3.0			3.0	
KWP II4	7.5			7.5			7.5	7.5			7.5	
Auwahi	9.4	1.0		21.0	1.0	1.0	20.0	20.0	1.0	1.0	21.0	1.0
Solar	0.0	0.0	79.9	18.8	79.9	18.8	79.9	18.8	79.9	18.8	0.0	0.0
Load	95	94.3	136.4	138.6	136.2	137.4	200.8	202.9	199.9	202.2	224.6	224.2
Req Up	27	6	28	28	28	19.54	28	28	28	19.54	27	6
Up Res	61.4	33.7	62.3	48.2	71.7	21.9	48.1	28.9	54	23.6	28.4	8.2
Ramp	5.3	8.3	5.3	5.3	8.3	9.3	5.3	9.3	11.3	14.3	12.3	18.3

Table 6-5: 2019 Dispatch Cases

Unit	Minimum		Daytime Minimum				Daytime Peak				Peak	
	Windy	Calm	Windy Sunny	Windy Cloudy	Calm Sunny	Calm Cloudy	Windy Sunny	Windy Cloudy	Calm Sunny	Calm Cloudy	Windy	Calm
M14	9.6	18.2	7.7	11.2	9.8	16.5	8.6	16.8	13.7	19.6	21.3	21.4
M15	5.6	12.5	3.0	7.0	6.0	12.0	3.8	11.2	9.6	12.7	13.4	13.6
M16	9.6	18.2	7.8	11.0	9.7	16.5	8.6	16.8	13.7	19.6	21.3	21.5
M17		15.0		13.0		16.0	13.0	15.0	15.0	17.0	20.0	22.0
M18		4.5				5.0						
M19								15.0	15.0	17.0	20.0	22.0
HCS												
M10		12.0				11.0		11.0	11.0	12.0	12.0	12.0
M11		12.0				11.0		11.0	11.0	12.0	12.0	12.0
M12						11.0		11.0	11.0	12.0	12.0	12.0
M13						11.0		11.0		12.0	12.0	12.0
M4										5.0	5.0	5.0
M6										5.0		5.0
M8										5.0		5.0
M9										5.0		5.0
M1												2.5
M2												2.5
M5												5.0
M7												5.0
ICE1										16.0	17.0	17.0
ICE2										16.0		17.0
ICE3												17.0
KWP1	30.0	2.0	10.0	30.0	2.0	2.0	30.0	30.0	2.0	2.0	30.0	2.0
KWP II1	4.5			4.5			4.5	4.5			4.5	
KWP II2	6.0			6.0			6.0	6.0			6.0	
KWP II3	3.0			3.0			3.0	3.0			3.0	
KWP II4	7.5			7.5			7.5	7.5			7.5	
Auwahi	21.0	1.0		21.0	1.0	1.0	19.0	20.0	1.0	1.0	21.0	1.0
Solar	0.0	0.0	108.8	25.6	108.8	25.6	108.8	25.6	108.8	25.6	0.0	0.0
Load	96.8	95.4	137.3	139.8	137.3	138.6	212.8	215.4	211.8	214.5	238	237.5
Req Up	27	6	28	28	28	24.07	28	28	28	24.07	27	6
Up Res	35.2	21.6	41.5	39.8	34.5	29	50	35.2	46	23.5	27.6	7.1
Ramp	5	10	5	7	5	12	7	13	12	17	14	19

The two transmission configurations used for the 2019 year had slightly different losses. These losses were picked up by the M14 unit.

Throughout this report, the case names will be referenced by a short-hand to save space. These short-hand names are assigned based on the year (2014, 2016, 2019), load level (minimum = m, daytime minimum = dm, daytime peak = dp, peak = p), wind level (windy = wnd, calm = clm), and solar level (sunny = sun, cloudy = cld). The 2014 daytime minimum case with high wind and high solar would be named "2014_dm_wnd_sun".

The DG was configured with two sets of trip settings. The first set follows the original Rule 14H trip settings with an under-frequency trip setting of 59.3 Hz. Based on the observations made during the benchmarking process, it was assumed that approximately 12 MW of the DG uses the original Rule 14H trip settings. All 2014, 2016, and 2019 cases assume that 12 MW of capacity will trip using these trip settings. All remaining DG will use the existing Rule 14 H settings which specify an under-frequency trip setting of 57.0 Hz. However, it is important to note that the currently revised Rule 14 H does not require the renewable generation to "ride through" until a frequency of 57.0 Hz is reached. Rather, the revised rule 14 H specifies that the

generation “must trip” at a frequency between of 57.0 Hz, but tripping at a frequency above 57.0 Hz is permissible. Renewable generation that trips at a frequency above 57.0 Hz presents a risk to the operations of the MECO system.

Table 6-6: PV Trip Settings

	IEEE 1547				Revised Rule 14 H			
	Setpoint	Delay (s)	Setpoint	Delay (s)	Setpoint	Delay (s)	Setpoint	Delay (s)
Under Frequency	<59.3 Hz	0.167			57	0.167		
Over Frequency	>60.5 Hz	0.167			>60.5 Hz	0.167		
Under Voltage	<0.88 PU	2	<0.5 PU	0.167	<0.88 PU	2	<0.5 PU	0.167
Over Voltage	>1.1 PU	1	>1.2 PU	0.167	>1.1 PU	1	>1.2 PU	0.167

In addition to the PV trip settings shown in Table 6-6, the PV that is connecting to the MECO system on UFLS feeders will also trip at the same frequency that the UFLS feeders trip.

7 Steady-State Power Flow Analysis and Results

Contingency analysis was performed for each of the MECO dispatch cases. The contingency cases analyzed included every 69 kV transmission line, every 69/23 kV transformer, and every 23 kV line section. These contingencies were applied to all of the MECO dispatch cases. The dispatch cases were intentionally created to give a wide array of potential operating conditions, to assess the impact that the curtailment reduction plan has on the steady state voltage and flow requirements.

7.1 Line Overloads

There were no contingencies that caused flow violations in excess of the “B” / emergency rating in the PSS/E database. There were some contingencies that resulted in line or transformer flows that were higher than the “A” / normal rating. These contingency results are shown below in Table 7-1.

Table 7-1: Line Overload Contingency Results

Case	Contingency	Overloaded Line					
		From Bus	To Bus	kV	Current(MVA)	Rating 'A'	Rating 'B'
2016_p_clm	Maalaea - Kula AG 69 kV	Kihe	Maalaea	69	63.32	61.50	71.10
2016_p_clm	Kealahou-Kula AG 69 kV	Kihe	Maalaea	69	61.62	61.50	71.10
2019_p_clm	Wailuku-Kahului 23 kV	Waiinu 69/23 kV XFMR			23.69	20.00	26.67
2019_p_wnd	Wailuku-Kahului 23 kV	Waiinu 69/23 kV XFMR			23.81	20.00	26.67
2019 Alternate Transmission Upgrade Plan							
2019_p_clm	Kihe-Maalaea 69 kV	Wailea	AWFTAP	69	65.75	61.50	71.10
2019_p_clm	Kihe-Maalaea 69 kV	Kealahou	AWFTAP	69	64.40	61.50	71.10
2019_p_clm	Wailuku-Kahului 23 kV	Waiinu 69/23 kV XFMR			23.65	20.00	26.67
2019_p_wnd	Kihe-Maalaea 69 kV	Wailea	AWFTAP	69	64.21	61.50	71.10
2019_p_wnd	Wailuku-Kahului 23 kV	Waiinu 69/23 kV XFMR			23.73	20.00	26.67

Table 7-1 shows the line worst case contingency conditions, and worst case line overloads for the cases studied. The ‘Case’ column lists the dispatch case, the ‘Contingency’ column lists the line section that is out of service. The ‘Overloaded Line’ columns describe the line that is above

its normal rating. The 'Current (MVA)' column lists the line current with the specified line out of service. Since PSS/E uses MVA ratings for line limits, the 'Current (MVA)' column lists the MVA flow on the line if the voltage were 1.0 per unit.

Only the peak cases had any line loading levels that exceeded the line's 'A' rating. The worst case contingency seen in the 2016 year is the loss of the Maalaea – Kula 69 kV line. The loss of this line along with the AWF wind farm near zero generation will increase the loading on the Kihei – Maalaea 69 kV line to approximately 63.32 MVA which would exceed the 'A' rating, but is below the 'B' rating of the line.

The upgrades in the preferred transmission plan remove the overloads associated with the Kihei-Maalaea 69 kV outage. The only outage of concern is the Wailuku-Kahului 23 kV line for year 2019. The Waiinu transformer loading increased above the normal rating, but below the emergency rating when the Wailuku-Kahului line is out of service.

The alternate transmission configuration for 2019 peak cases had high flow on the Wailea – AWFTAP – Kealahou line when the Kihei – Maalaea 69 kV line is out of service. The peak case had approximately 59.5 MVA flowing along the AWFTAP-Wailea line section, but due to the low voltage associated with this contingency (0.89 pu voltage if AWF BESS provides no support) the current exceeds the line's limit. The addition of a switched capacitor bank with a rating of 18 MVAR would bring the voltage up to 0.962 per-unit, and reduce the loading on the AWFTAP-Wailea line below its 'A' rating. Assuming equal load growth on the island between 2014 and 2019, the loading of the Waiinu 69/23 kV transformer will be near its limit when the Wailuku – Kahului 23 kV line is out of service.

7.2 Bus Voltage Violations

The bus voltage at every 69 kV and 23 kV bus was monitored for each line section outage on the MECO system. Only three buses had a voltage that was outside the 0.9 pu – 1.05 pu range for any contingency. The buses were the Waiinu 69 kV bus for the Waiinu – Maalaea 69 kV line outage, and the REG 23 kV bus (on the Pukalani 23 kV line) for the Hana – Kanae 23 kV line outage, and the Kihei 69 kV bus for the Maalaea – Kihei line outage.

The voltage violation seen at the Waiinu 69 kV bus (#636) is a result of back-feeding the 69 kV bus from the 23 kV system. The database has the Waiinu 69/23 kV transformer with a voltage regulator controlling the 23 kV bus voltage. When the Maalaea – Waiinu transmission line is out of service, this transformer will back-feed to serve the load fed off the 69 kV bus from the 23 kV system. In the PSS/e program, the transformer will change taps to regulate the 23kV voltage. When simulating this contingency, the transformer taps change such that the 69 kV voltage is well below 0.90 per-unit. However, should MECO either have the capability to control the taps on the 69/23 kV Waiinu transformer, or have reverse power controls on the transformer, the taps can be configured such that the Waiinu 69 kV bus is kept within its voltage limit. If MECO can control the taps on the Waiinu 69/23 kV transformer there would be no voltage violations any dispatch scenario for the loss of the Waiinu – Maalaea 69 kV line.

The REG 23 kV bus is fed off the Pukalani 23 kV feeder and is located just upstream of the 100kVA 23 kV regulator. When the line section between Kanae and Hana is out of service, the two 600 kVAR capacitor banks and the loss of the load downstream of the Kanae – Hana line section can cause a slightly high voltage at the REG bus of 1.06 per unit voltage. However, when the two capacitor banks are switched offline, the voltage would recover below 1.05 per unit voltage. In general, this circuit seems to have the most difficulty regulating the voltage. The tap-changer at Pukalani is not able to properly regulate the voltage on this circuit as the amount of distributed generation increases.

Both 2019 peak case can see voltages as low as 0.89 per unit, while the 2019 daytime minimum cases with high solar generation can see voltages as high as 1.06. Additional voltage control resources are required on this feeder to properly maintain the voltage along the entire circuit length since the current Pukalani tap changer transformer settings cannot control the voltage along the length of the circuit.

Several 69 kV line outages cause voltages as low as 0.89 per unit at the REG 23 kV bus in the 2019 peak cases. Depending on the outage, the low voltage can be mitigated with reactive support from Waena power plant or AWF. The following table shows the REG 23 kV voltage for various outages and mitigation steps.

Table 7-2: REG 23 kV Bus Voltage for Contingencies with 2019_p_wnd Dispatch

Outage	No Mitigation Steps	AWF Control 1.01 PU BESS 7MVAR	Waena Control to 1.025 PU	XFMR Vmin to 0.995 PU
Puunene-PuuneneA	0.897	0.896	0.905	0.916
PuuneneA-Kanaha	0.897	0.896	0.905	0.916
Maalaea-PuuneneB	0.899	0.897	0.894	0.917
Puunene-PuuneneB	0.899	0.897	0.894	0.917
Kealahou-Kula	0.902	0.902	0.897	0.911
Kula-Pukalani	0.902	0.902	0.908	0.911
Waena-Pukalani	0.898	0.904	0.897	0.915

In general, the two closest generation resources (Waena, AWF) have little impact on voltage along the Pukalani feeder. The voltage control deadband of the Pukalani 69/23 kV transformer is from 1.015 to 0.985 per unit. When these outages occur, the voltage at the low side of the Pukalani transformer is just above 0.985 per unit, and the voltage drop along the circuit is large enough to cause a voltage violation. Setting the transformer low voltage setpoint to 0.995 instead of 0.985 resolved the low voltage problem at the REG 23 kV bus.

No other voltage violations exist with the preferred transmission upgrade plan. However, there were some voltage violations with the alternate transmission configuration.

Low voltages can occur at the Kihei 69 kV bus at peak load with the AWF plant out of service, and providing no voltage support. The voltage can go down to 0.902, 0.883, 0.887 per unit in the 2014, 2016, and 2019 peak cases, respectively. With the addition of 4 MVAR at the Kihei substation, the voltage recovers above the 0.90 per unit voltage limit. EPS recommends additional VAR support at the Kihei substation to improve the voltage for the loss of the Maalaea – Kihei line.

In order to maintain the generator power factors near 0.95, all MECO capacitor banks were switched in for the peak case. EPS recommends additional voltage support resources are added to the system for peak loading conditions with at least 4 MVAR at Kihei.

8 Transient Stability Analysis and Results

EPS performed transmission line fault and generation unit trip simulations to assess the transient stability of the system. These simulations assumed clearing times of 9 cycles on the near end of a line fault, and 22 cycles on the far end of the fault. The transformer fault and trip scenarios assumed clearing times of 7 cycles. EPS ran simulations shown in Table 8-1 for each of the 36 dispatch cases. The simulation plots are attached in Appendix C.

Table 8-1: Transient Stability Simulations

Unit Trips	Transformer Trips			Line Faults			
	Substation	XFMR	Fault T	From Bus	To Bus	Near T	Far T
M10	Kanaha	69/23 kV	0.1167	Maalaea	Lahaluna	0.15	0.3667
M14	Puunene	69/23 kV	0.1167	Maalaea	KWP	0.15	0.3667
M15	Waiinu	69/23 kV	0.1167	Maalaea	Waiinu	0.15	0.3667
M16				Maalaea	Kihei	0.15	0.3667
HC&S				Kanaha	Puunene	0.15	0.3667
AWF				Lahaina	Lahaluna	0.15	0.3667
KWP							

For the line faults, the 'Near T' and 'Far T' column lists the fault clearing time from the breaker closer to and farther away from the fault location, respectively. The 'Fault T' column for 'Transformer Trips' represents the total time to clear the respective transformer faults.

8.1 Transient Stability Results

Each unit trip with each dispatch case resulted in a stable system with the BESS support assumed in the base case. Voltages remained within tolerance, and the frequency recovered to near 60 Hz following load shedding. Table 8-2 shows the number of stages of load shedding required to arrest system frequency decay.

Table 8-2: UFLS Stages for Unit Trip Simulations

Outage	Dispatch	2014	2016	2019
KWP	m_wnd			3
	m_clm			
	dm_wnd_sun	2		
	dm_wnd_cld	1	1	2
	dm_clm_sun			
	dm_clm_cld			
	dp_wnd_sun		1	2
	dp_wnd_cld			
	dp_clm_sun			
	dp_clm_cld			
	p_wnd			1
	p_clm			
M14	m_wnd			
	m_clm			
	dm_wnd_sun			
	dm_wnd_cld			
	dm_clm_sun			
	dm_clm_cld			
	dp_wnd_sun			
	dp_wnd_cld			
	dp_clm_sun			
	dp_clm_cld			
	p_wnd			
	p_clm			1

Table 8-2 shows that the loss of KWP requires multiple stages of load shed. The 2019 minimum case required all three stages of load shed to arrest system frequency decay putting the system at risk of collapse. We believe a revision to the UFLS scheme would provide improved protection for the system in this case.

The transformer fault and trip scenarios also resulted in a stable system response for each dispatch case. However, several line fault and trip scenarios resulted in instability or blackout of the entire system. During the course of the project, MECO provided the designed clearing times for the transmission lines tripped in this study. The fault clearing times as provided are shown in Table 8-3 below.

Table 8-3: Expected Clearing Times

	Maalaea - Lahaluna		Maalaea - KWP		Maalaea - Waiinu		Maalea - Kihei		Lahaina - Lahaluna		Kanaha - Puunene	
	Near	Far	Near	Far	Near	Far	Near	Far	Near	Far	Near	Far
Breaker Time	3 cyc	3 cyc	5 cyc	3 cyc	5 cyc	3 cyc	3 cyc	3 cyc	3 cyc	3 cyc	3 cyc	3 cyc
POTT	y		y		n		y		n		y	
Clearing Time	5 cyc	5 cyc	7 cyc	7 cyc	7 cyc	31cyc	5 cyc	5 cyc	5 cyc	29cyc	5 cyc	5 cyc

During the course of the study, simulations with two sets of clearing times were used. The first set of clearing times for the 69 kV transmission lines was 9 cycles on the near end and 22 cycles on the far end. The second set of clearing times (Pilot Protection sensitivity section) used was 5 cycles on the near end and 7 cycles on the far end. The following table, Table 8-4 shows the results that most closely represent the results with today's protection system. For each transmission line with a POTT protection scheme, the 5 cycle/7 cycle clearing time results are used, and for each line without POTT, the 9 cycle/22 cycle clearing time is used.

Table 8-4: Line Fault Results - Current Protection System

		2014	2016	2019	2019		2014	2016	2019	2019
					Alt					Alt
Outage	Case	Minimum Freq.				Outage	Minimum Freq.			
Maalaea - Lahaina	m_wnd	59.8	59.5	59.7	59.6	Maalaea - KWP	59.8	59.5	59.6	59.6
	m_clm	59.7	59.7	59.6	59.6		59.7	59.7	59.6	59.6
	dm_wnd_sun	59.8	60.0	59.8	59.8		59.8	60.0	59.8	59.8
	dm_wnd_cld	59.7	59.8	59.2	59.9		59.6	59.8	59.2	59.9
	dm_clm_sun	59.7	59.9	59.6	59.6		59.7	59.9	59.6	59.6
	dm_clm_cld	59.5	59.6	59.4	59.7		59.5	59.6	59.4	59.7
	dp_wnd_sun	59.9	60.0	xx	60.0		59.9	59.9	xx	60.0
	dp_wnd_cld	59.8	59.8	59.8	59.9		59.8	59.8	59.8	59.9
	dp_clm_sun	59.1	59.7	xx	xx		59.1	59.7	xx	xx
	dp_clm_cld	59.4	59.2	59.0	59.0		59.4	59.3	59.0	59.0
	p_wnd	59.8	60.0	59.7	60.0		59.9	60.0	59.8	60.0
	p_clm	59.5	59.6	59.4	59.6		59.5	59.6	59.4	59.6
Maalea - Waiinu	m_wnd	59.9	59.8	59.8	59.7	Maalea - Kihei	59.9	59.7	59.8	59.8
	m_clm	59.5	59.4	59.5	59.4		59.9	59.8	59.8	59.8
	dm_wnd_sun	59.6	59.6	xx	xx		60.0	60.0	59.9	57.2
	dm_wnd_cld	59.6	59.6	59.1	59.2		59.8	60.0	59.3	60.0
	dm_clm_sun	58.5	59.4	xx	xx		59.6	60.0	59.5	xx
	dm_clm_cld	58.9	58.6	59.1	59.2		59.5	59.5	59.5	59.2
	dp_wnd_sun	59.4	59.5	xx	xx		60.0	60.0	57.5	xx
	dp_wnd_cld	59.5	58.9	59.6	58.8		59.9	59.7	59.9	60.0
	dp_clm_sun	58.2	57.5	xx	xx		58.9	58.6	xx	xx
	dp_clm_cld	58.9	58.6	58.2	58.2		59.6	59.4	59.3	59.4
	p_wnd	59.5	59.5	59.0	59.0		60.0	60.0	60.0	60.0
	p_clm	59.1	59.2	58.7	58.8		59.8	59.9	59.6	59.9
Kanaha - Puunene	m_wnd	59.7	59.6	59.1	59.2	Lahaina - Lahaluna	59.2	59.4	58.9	59.2
	m_clm	59.8	59.8	59.7	59.6		59.7	59.6	59.4	59.5
	dm_wnd_sun	59.7	59.6	59.6	59.6		58.3	57.0	xx	xx
	dm_wnd_cld	59.6	59.7	59.5	59.5		59.2	59.4	58.3	58.4
	dm_clm_sun	59.8	59.7	59.5	59.5		59.5	59.7	xx	xx
	dm_clm_cld	59.7	59.8	59.7	59.7		59.1	59.5	58.8	58.8
	dp_wnd_sun	59.8	59.7	59.5	59.5		59.4	57.5	xx	xx
	dp_wnd_cld	59.8	59.8	59.8	59.8		59.6	59.4	59.8	59.7
	dp_clm_sun	59.7	59.8	59.6	59.6		58.3	59.6	58.2	58.6
	dp_clm_cld	59.7	59.7	59.5	58.9		59.1	58.8	58.6	58.6
	p_wnd	59.8	59.8	59.7	59.8		59.6	59.6	59.5	59.4
	p_clm	59.7	59.7	59.4	59.3		59.3	59.3	59.1	59.1

The 2014, 2016, 2019, and 2019 alt columns list the dispatch year, the 'Outage' column lists the contingency. The 'Case' column lists the dispatch case. The cells that are highlighted in green represent the simulations that had one stage of load shedding. The yellow cells had 2 stages, and the orange cells had three stages. The red cells with 'xx' represent the cases that resulted in system instabilities or blackouts. The numerical value in each cell shows the frequency nadir. The Maalaea – Waiinu and Lahaina – Lahaluna outages are the most severe since these lines do not have a POTT scheme. With the shorter clearing times of 5/7 cycles the Kanaha – Puunene, Maalaea – Lahaluna, Maalaea – KWP, and the Maalea – Kihei outages are less severe. Other than for the Kanaha – Puunene line, every transmission line outage studied can result in system collapse in the 2019 year, and multiple stages of load shedding can occur for sunny conditions in 2014 and 2016.

Table 8-5 below shows the dispatch cases, contingency events, and minimum system frequency for the simulations that only use the phase step distance protection with clearing times of 9/22 cycles. The results in Table 8-5 are the same as seen in Table 8-4 for the Maalaea – Waiinu and Lahaina – Lahaluna lines.

Table 8-5: Line Fault Results – No Comms / Comms Failure

		2014	2016	2019	2019			2014	2016	2019	2019
					Alt						Alt
Outage	Case	Minimum Freq.				Outage	Minimum Freq.				
Maalaea	m_wnd	59.3	59.5	59.6	59.9	Maalaea - KWP	59.1	59.2	59.3	59.8	
	m_clm	59.5	59.4	59.6	59.6		59.5	59.4	59.6	59.6	
	dm_wnd_sun	58.9	58.4	xx	xx		58.4	57.6	xx	xx	
	dm_wnd_cld	59.1	59.5	59.9	59.4		58.9	59.2	59.1	59.9	
	dm_clm_sun	58.2	59.4	xx	xx		58.2	59.4	xx	xx	
	dm_clm_cld	58.8	58.5	59.2	59.2		58.8	58.5	59.2	59.2	
	dp_wnd_sun	59.4	59.3	59.9	59.9		59.3	58.2	59.7	xx	
	dp_wnd_cld	59.4	58.9	59.6	58.9		59.4	59.0	59.6	58.9	
	dp_clm_sun	58.1	57.7	xx	xx		58.1	57.7	xx	xx	
	dp_clm_cld	58.8	58.6	58.4	58.4		58.8	58.5	58.4	58.4	
	p_wnd	59.6	59.5	59.2	59.4		59.6	59.5	59.2	59.4	
	p_clm	59.0	59.1	58.9	59.0		59.0	59.1	58.8	59.0	
Maalaea - Waiinu	m_wnd	59.9	59.8	59.8	59.7	Maalaea - Kihēi	59.6	59.6	59.5	59.9	
	m_clm	59.5	59.4	59.5	59.4		59.6	59.6	59.6	59.7	
	dm_wnd_sun	59.6	59.6	xx	xx		59.5	59.3	xx	xx	
	dm_wnd_cld	59.6	59.6	59.1	59.2		59.5	59.8	59.2	59.7	
	dm_clm_sun	58.5	59.4	xx	xx		58.5	59.1	xx	xx	
	dm_clm_cld	58.9	58.6	59.1	59.2		59.2	59.1	59.4	59.4	
	dp_wnd_sun	59.4	59.5	xx	xx		59.6	59.4	xx	59.2	
	dp_wnd_cld	59.5	58.9	59.6	58.8		59.6	59.4	59.9	59.3	
	dp_clm_sun	58.2	57.5	xx	xx		58.5	58.0	xx	xx	
	dp_clm_cld	58.9	58.6	58.2	58.2		59.2	59.1	58.6	58.8	
p_wnd	59.5	59.5	59.0	59.0	59.8	59.7	59.3	59.7			
p_clm	59.1	59.2	58.7	58.8	59.4	59.5	59.1	59.3			
Kapaunahāne	m_wnd	59.4	59.4	58.9	59.2	Lahaina - Lahaluna	59.2	59.4	58.9	59.2	
	m_clm	59.6	59.6	59.2	58.7		59.7	59.6	59.4	59.5	
	dm_wnd_sun	58.3	xx	xx	xx		58.3	57.0	xx	xx	
	dm_wnd_cld	59.3	59.1	58.1	58.2		59.2	59.4	58.3	58.4	
	dm_clm_sun	58.3	56.7	xx	xx		59.5	59.7	xx	xx	
	dm_clm_cld	59.1	59.0	58.6	58.1		59.1	59.5	58.8	58.8	
	dp_wnd_sun	58.6	56.8	xx	xx		59.4	57.5	xx	xx	
	dp_wnd_cld	59.6	59.2	59.1	58.4		59.6	59.4	59.8	59.7	
	dp_clm_sun	58.4	57.7	xx	xx		58.3	59.6	58.2	58.6	
	dp_clm_cld	59.2	59.0	58.1	xx		59.1	58.8	58.6	58.6	
p_wnd	59.7	59.7	xx	xx	59.6	59.6	59.5	59.4			
p_clm	59.3	59.3	xx	xx	59.3	59.3	59.1	59.1			

In 2014, the loss of PV with the sunny cases needed 1 or 2 sages of load shedding. The 2016 cases needed 3 stages of load shedding, and was unstable for the dm_wnd_sun case. The 2019 sunny cases mostly resulted in system collapse after the loss of the PV. In fact, even several of the 2019 cloudy cases had 1 or 2 stages of load shedding. Even with low solar irradiance, the loss of solar capacity in 2019 needs load shedding to arrest system frequency decay. An example of the system collapse is shown below in Figure 8-1.

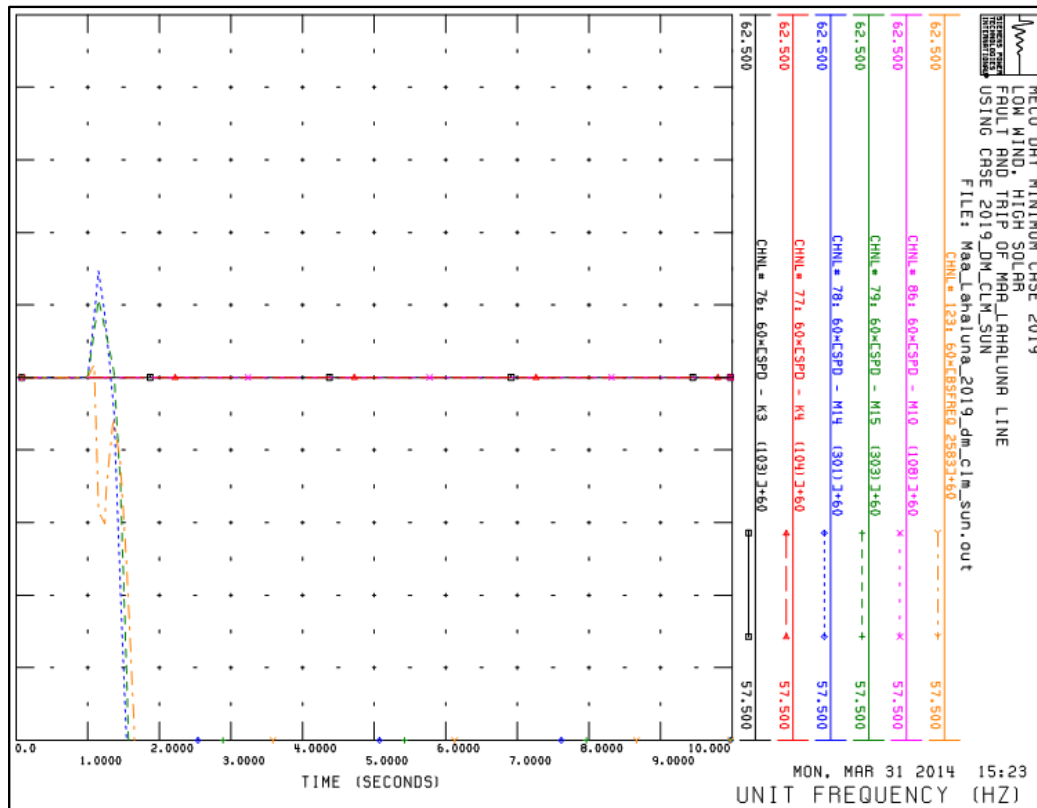

Figure 8-1: System Collapse for Maalaea - Lahaluna Line Fault

Figure 8-1 shows the system frequency for the Maalaea – Lahaluna line fault with the 2019 daytime minimum dispatch case with low wind and high solar generation without POTT protection. The system frequency is shown on a scale from 57.5 Hz to 62.5 Hz. Since the fault is near the Maalaea generation station, and the wind output low, there is no voltage support on the MECO system, and the entire island is subject to low voltages. For this event, all of the solar generation trips offline due to under-voltage protection at a voltage of 50% for 0.167 seconds. The loss of more than 100 MW of solar generation is nearly impossible to survive with the existing UFLS scheme. Approximately 75% of all the MECO system load would have needed to be tripped as part of the UFLS system to match the loss of generation. The current MECO UFLS system has approximately 25% of the system load on the UFLS feeders, and would be inadequate for a three-phase fault that lasted this long with the amount of PV projected for the year 2019.

The primary driver of the system instability is the tripping of the distributed generation when either the voltage is below 0.50 per-unit for 10 cycles or the frequency exceeds 60.5 Hz for 10 cycles. Both of these conditions are likely with the long clearing times used in this study.

In addition to the stability problems caused by the loss of PV, the 2019 peak case with low wind generation would be unstable for the fault and trip of the Kanaha – Puunene line. This outage caused the generation at Waena to lose synchronism with the generation at Maalaea. This was largely due to the different rates of acceleration at the two plants for this fault. In addition, the 2.5 MW diesel units lost synchronism with the other generation for some of the faults with the 2016_p_clm and 2019_p_clm dispatch cases. A more in-depth discussion will be covered in the Critical Clearing Times section of this report.

8.2 BESS Sensitivity Cases

EPS ran several sensitivity cases to determine the impact that the BESS availability has on the system response to unit trip and line fault contingencies. EPS simulated the same outages discussed earlier in this report with five different BESS availability levels of 0 MW, 5 MW, 10 MW, 15 MW, and 21 MW. The availability and limits of the two BESS systems used in these sensitivity cases is shown below in Table 8-6.

Table 8-6: BESS Availability

System-Wide BESS Capacity	BESS Availability	
	KWP 2	AWF
0 MW	0 MW	0 MW
5 MW	5 MW	0 MW
10 MW	10 MW	0 MW
15 MW	10 MW	5 MW
21 MW	10 MW	11 MW

As shown in Table 8-6, the AWF BESS is offline for system-wide BESS capacities of 10 MW or less. Due to the design of the AWF BESS, the AWF BESS code was modified to provide droop response when the AWF wind farm is either offline or at peak capacity. This characteristic is not currently available in the AWF BESS.

The 10 MW sensitivity cases are closely related to the original simulations and can be used as the benchmark showing the impact that battery availability has on the system response. Line faults and most unit trips will have nearly identical system responses. The AWF unit contingency was the only contingency with significantly different response. The 10 MW sensitivity case has the AWF BESS offline, whereas the original cases have the AWF BESS online but only providing ramp rate support. The AWF unit contingency would see a large response from the AWF BESS in the original cases to limit the ramp rate, and no response from the AWF BESS in the 10 MW sensitivity case to respond to a system contingency.

8.2.1 BESS Sensitivity – Unit Trip Results

All simulations using the 2014 or 2016 year dispatch cases were stable, but the loss of the M14 unit in the 2019 year could cause system instability. Without BESS support, all three stages of load shed are needed to arrest system frequency decay for KWP plant outage in 2014, 2016 and 2019. All cases with lower levels of BESS support resulted in increased loadshedding and lower system frequencies. The low frequencies and high df/dt rate observed in these events increase the risk for subsequent outages. With these larger df/dt, MECO should determine whether the unit controls, particularly the combustion turbines, can handle the larger df/dt with when the BESS systems are not available for frequency support. We have seen situations when the large df/dt can cause a combustion turbine to trip on over-temperature when the temperature control is not properly tuned for high df/dt events.

With minimal BESS support (0, 5 MW) an increased number of unit trips resulted in activation of all under frequency load shedding. Shedding all available UFLS load and low system frequencies put the system at significant risk of collapse. Unit trips were stable for the 2014 and 2016 cases, but three 2019 cases collapsed. The 2019 cases that collapsed will be further discussed below. Table 8-7 below shows the number of stages of load shed needed to arrest system frequency decay. Green squares represent acceptable load shed response of 1 stage of UFLS, yellow squares indicate unacceptable UFLS of two stages and red squares indicate all stages of UFLS. The plots of these unit trip simulations are attached in Appendix D.

Table 8-7: BESS Sensitivity - Number of UFLS Stages Shed

Outage	Dispatch	2014					2016					2019				
		0	5	10	15	21	0	5	10	15	21	0	5	10	15	21
AWF	m_wnd						1					3	2	2		
	m_clm															
	dm_wnd_sun															
	dm_wnd_cld	1					1					3	3	1		
	dm_clm_sun															
	dm_clm_cld															
	dp_wnd_sun						2	1				3	2	1		
	dp_wnd_cld															
	dp_clm_sun															
	dp_clm_cld															
	p_wnd											1	1	1		
	p_clm															
KWP	m_wnd	2	2	1			2	2	1			3	3	3	2	2
	m_clm															
	dm_wnd_sun	3	3	2	1		2	2	1			3				
	dm_wnd_cld	2	2	1			2	2	1			3	3	2	2	1
	dm_clm_sun															
	dm_clm_cld															
	dp_wnd_sun	2	2	1			3	2	2	1		3	3	3	2	2
	dp_wnd_cld	1										1				
	dp_clm_sun						2	1								
	dp_clm_cld															
	p_wnd	1	1				1					2	2	1	1	
	p_clm															
M14	m_wnd											2				
	m_clm											1	1			
	dm_wnd_sun	2										3				
	dm_wnd_cld	1										3				
	dm_clm_sun	1										3	3			
	dm_clm_cld	1	1				1	1								
	dp_wnd_sun	1					1					3				
	dp_wnd_cld						1									
	dp_clm_sun															
	dp_clm_cld	1	1									1				
	p_wnd											1	1	1		
	p_clm	1	1				1	1				1	1	1		

In general, the BESS support reduced the number of stages that were required to arrest the frequency decay. More stages of UFLS are used in 2019 because there are fewer units online compared to 2014 and 2016 and increased PV penetration on the feeders limits the effectiveness of each stage of UFLS. The frequency collapsed for several of the 2019 unit outages even after activating all stages of UFLS. We recommend that MECO revise its UFLS scheme to protect against single unit outages and outages involving multiple units or the BESS and other units. We also recommend MECO investigate the use of dynamic load shedding for its system to vary the number of feeders on each stage depending on the amount of PV on each feeder.

Figure 8-2 shows the impact that the BESS availability has on the system frequency response for the loss of the KWP plant with the 2014_dm_wnd_sun dispatch.

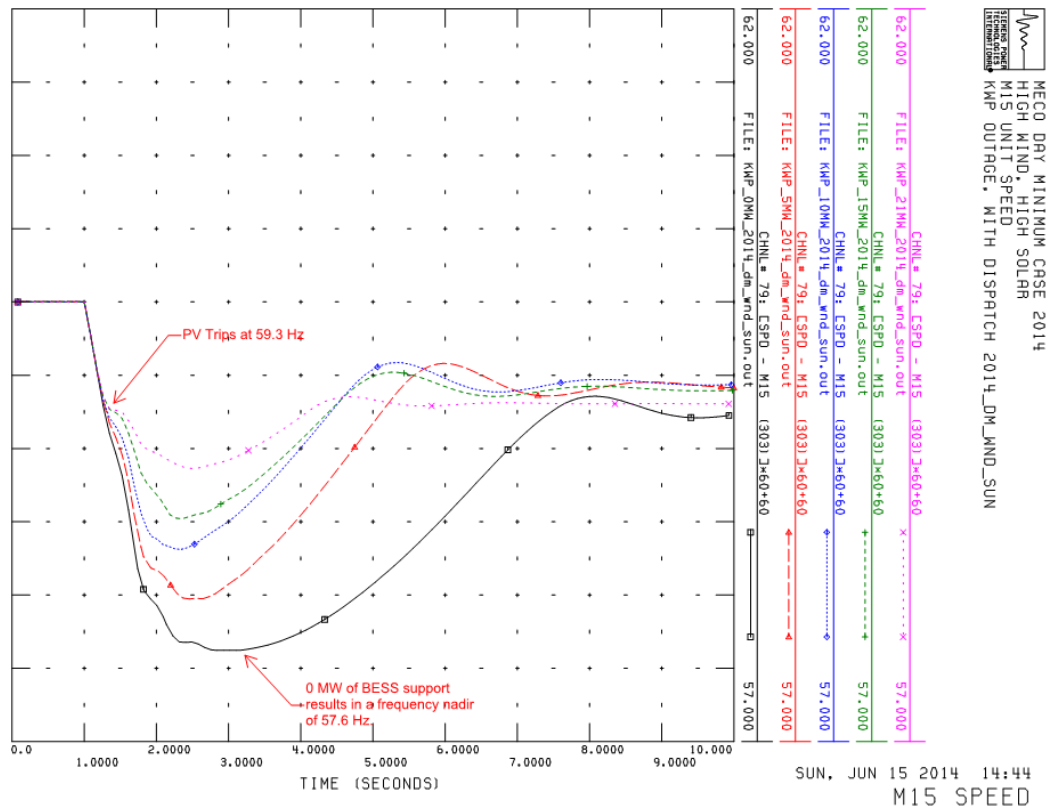

Figure 8-2: BESS Sensitivity Results for 2014 KWP Trip

Figure 8-2 shows the speed of the M15 unit after the loss of the KWP plant at 1.0 seconds and subsequent loss of approximately 10 MW of PV at 59.3 Hz. The frequency scale is from 57.0 to 62.0 Hz. The pink trace shows the results with 21 MW of BESS support while the green, blue, red, and black traces show the results for 15 MW, 10 MW, 5 MW, 0 MW of support, respectively. Without BESS support the KWP outage requires all three stages of load shed to arrest frequency decay but with 21 MW of BESS support, no load is shed.

Three simulations resulted in system collapse after the loss of the M14 unit. For these contingencies, the remaining units cannot prevent the loss of PV at either 57.0 Hz or 60.5 Hz following the loss of the M14 unit. Five MW of BESS support was able to prevent system collapse for all unit trips. Figure 8-3 shows the simulation results for the loss of the M14 unit with the different levels of BESS support and the 2019_dp_wnd_sun dispatch case.

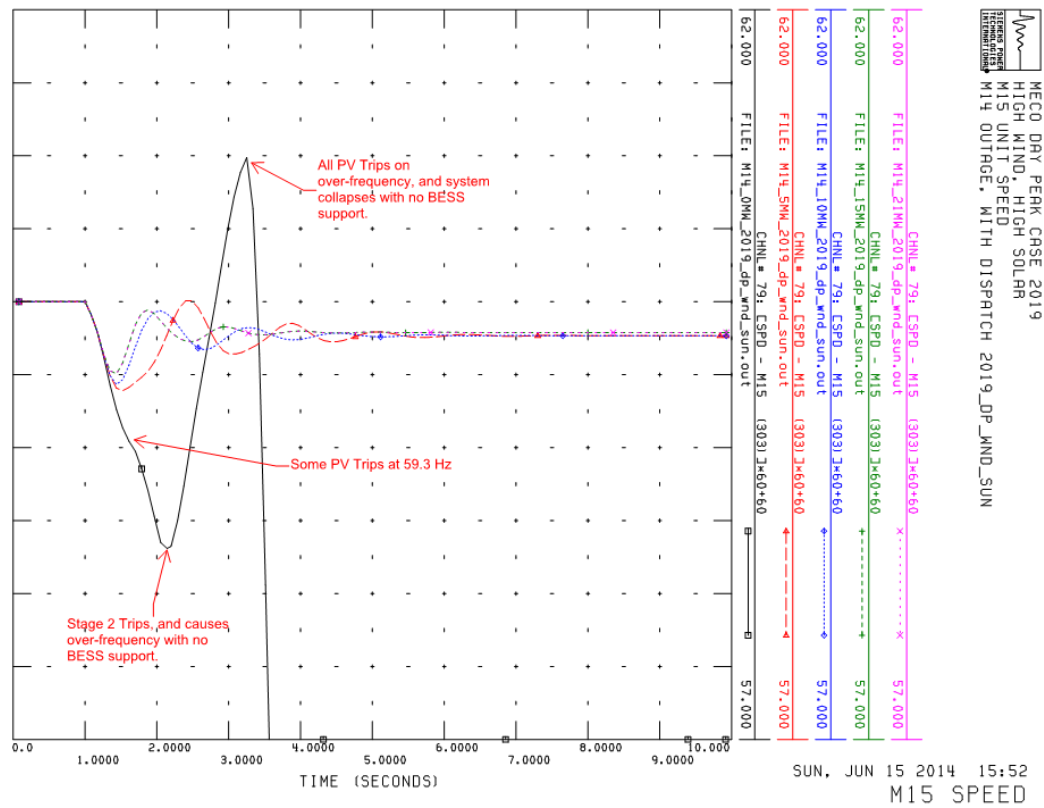

Figure 8-3: BESS Sensitivity Results for 2019 M14 Trip

The BESS support has a dramatic impact on the system frequency for the loss of the M14 unit in 2019. The BESS support prevents the PV tripping at 59.3 Hz and subsequent system collapse. Without the support of the BESS systems, the loss of M14 generating 9 MW can cause complete system collapse in 2019.

To further investigate these system collapses, we created three dispatch cases to see if an additional conventional unit could prevent system collapse for the three 2019 cases. Each of these cases had a high level of PV generation, so in order to add another conventional unit, the wind generation was curtailed. The original and alternate dispatch levels are shown below in Table 8-8.

Table 8-8: Alternate Dispatch Scenarios

2019						
Unit	Daytime Minimum				Daytime Peak	
	Windy Sunny	Alternate	Calm Sunny	Alternate	Windy Sunny	Alternate
M14	7.7	7.7	9.8	9.8	8.6	8.6
M15	3.0	3.0	6.0	6.0	3.8	3.8
M16	7.8	7.8	9.7	9.7	8.6	8.6
M17					13.0	13.0
M18						
M19						
HCS						
M10		8.0				8.4
M11						
M12						
M13						
M4				3.0		
M6						
M8						
M9						
M1						
M2						
M5						
M7						
ICE1						
ICE2						
ICE3						
KWP1	10.0	2.0	2.0		30.0	30.0
KWP II1					4.5	4.5
KWP II2					6.0	6.0
KWP II3					3.0	3.0
KWP II4					7.5	7.5
Auwahi			1.0		19.0	10.0
Solar	108.8	108.8	108.8	108.8	108.8	108.8

The dispatch levels that were changed are highlighted in gray. The system was unstable for each of three original dispatch scenarios for the M14 outage.

Table 8-9: Unit Outage Dispatch Sensitivity Results

	2019 Daytime Minimum		2019 Daytime Minimum		2019 Daytime Peak	
	Original	Alternate	Original	Alternate	Original	Alternate
M14 Outage	Unstable	Stable	Unstable	Unstable	Unstable	Stable

As seen in Table 8-9 the alternate dispatch configuration resolved the system instability for two of the three cases. The 2019 daytime minimum calm, sunny case represents an unacceptable operating condition. The combination of the loss of 9.8 MW, PV tripping at 59.3 Hz, and the reduced amount of net load on each feeder due to PV penetration resulted in a frequency collapse. In order to avoid system collapse for this unit outage, MECO would need to reduce the size of the outage (offload DTCC1), add BESS support, or increase the numbers of feeders shed in the UFLS system.

8.2.2 BESS Sensitivity – Line Fault Results

Table 8-10 through Table 8-12 show results for the BESS sensitivity simulations. The cells with red fill and the text 'xx' highlight the simulations that resulted in system collapse. The cells with green, yellow, and orange fill represent the simulations that resulted in load shedding of one, two, or three stages, respectively. The plots of these line fault simulations are shown in Appendix E. These line faults utilize line clearing times of 9 cycles near end and 22 cycles at the far end. Improved results could be expected with shorter clearing times.

Table 8-10: Fault Instability Results 1 of 3

Outage	Dispatch	2014					2016					2019				
		0	5	10	15	21	0	5	10	15	21	0	5	10	15	21
K 6 9 / 2 3 a	m_wnd	59.8	59.8	59.8	59.8	59.8	59.4	59.4	59.4	59.4	59.4	58.7	59.1	59.1	59.2	59.1
	m_clm	59.8	59.8	59.8	59.8	59.8	59.7	59.8	59.8	59.8	59.8	59.5	59.7	59.6	59.6	59.6
	dm_wnd_sun	59.8	59.8	59.8	59.8	59.8	59.7	59.7	59.7	59.7	59.7	59.6	59.6	59.6	59.7	59.7
	dm_wnd_cld	59.6	59.6	59.6	59.6	59.6	59.6	59.6	59.6	59.6	59.6	57.3	59.5	59.5	59.5	59.5
	dm_clm_sun	59.7	59.8	59.8	59.8	59.8	59.7	59.7	59.7	59.7	59.7	59.3	59.6	59.6	59.6	59.6
	dm_clm_cld	59.6	59.7	59.7	59.7	59.7	59.7	59.7	59.7	59.7	59.7	59.6	59.7	59.7	59.7	59.7
	dp_wnd_sun	59.8	59.8	59.8	59.8	59.8	59.6	59.6	59.6	59.6	59.6	xx	59.4	59.4	59.5	59.5
	dp_wnd_cld	59.8	59.8	59.8	59.8	59.8	59.7	59.8	59.8	59.8	59.8	59.8	59.8	59.8	59.9	59.9
	dp_clm_sun	59.6	59.7	59.7	59.7	59.7	59.7	59.8	59.8	59.8	59.8	59.5	59.6	59.6	59.6	59.6
	dp_clm_cld	59.6	59.7	59.7	59.7	59.7	59.6	59.7	59.7	59.7	59.7	58.6	58.7	58.9	59.1	59.1
	p_wnd	59.7	59.8	59.8	59.8	59.8	59.7	59.8	59.8	59.8	59.8	59.5	59.7	59.7	59.7	59.7
	p_clm	59.6	59.7	59.7	59.7	59.7	59.5	59.7	59.7	59.7	59.7	59.2	59.3	59.4	59.4	59.4
P 6 9 / 2 3 e	m_wnd	59.9	59.9	59.9	59.9	59.9	59.8	59.8	59.8	59.8	59.8	59.5	59.7	59.7	59.7	59.7
	m_clm	59.8	59.8	59.8	59.8	59.8	59.8	59.8	59.8	59.8	59.8	59.7	59.8	59.8	59.8	59.8
	dm_wnd_sun	59.8	59.8	59.8	59.8	59.8	59.8	59.8	59.8	59.8	59.8	59.5	59.6	59.6	59.7	59.7
	dm_wnd_cld	59.8	59.8	59.8	59.8	59.8	59.8	59.8	59.8	59.8	59.8	59.8	59.8	59.8	59.8	59.8
	dm_clm_sun	59.8	59.8	59.8	59.8	59.8	59.8	59.8	59.8	59.8	59.8	59.4	59.5	59.5	59.6	59.6
	dm_clm_cld	59.7	59.8	59.8	59.8	59.8	59.8	59.8	59.8	59.8	59.8	59.8	59.8	59.8	59.8	59.8
	dp_wnd_sun	59.7	59.8	59.8	59.8	59.8	59.7	59.8	59.8	59.8	59.8	59.7	59.8	59.8	59.8	59.8
	dp_wnd_cld	59.7	59.7	59.7	59.7	59.7	59.6	59.7	59.7	59.7	59.7	59.7	59.8	59.8	59.8	59.8
	dp_clm_sun	59.7	59.8	59.8	59.8	59.8	59.8	59.8	59.8	59.8	59.8	59.7	59.7	59.7	59.8	59.8
	dp_clm_cld	59.7	59.8	59.8	59.8	59.8	59.7	59.8	59.8	59.8	59.8	59.7	59.7	59.7	59.8	59.8
	p_wnd	59.6	59.7	59.7	59.7	59.7	59.7	59.7	59.7	59.7	59.7	59.6	59.7	59.7	59.7	59.7
	p_clm	59.8	59.8	59.8	59.8	59.8	59.8	59.8	59.8	59.8	59.8	59.6	59.7	59.7	59.7	59.7
W 6 9 / 2 3 u	m_wnd	59.6	59.6	59.6	59.6	59.6	59.3	59.4	59.4	59.4	59.5	xx	58.6	58.8	59.0	59.2
	m_clm	59.8	59.8	59.8	59.8	59.8	59.8	59.8	59.8	59.8	59.8	59.5	59.7	59.6	59.6	59.6
	dm_wnd_sun	59.6	59.6	59.6	59.6	59.6	59.7	59.7	59.7	59.7	59.7	59.6	59.6	59.6	59.7	59.7
	dm_wnd_cld	59.4	59.4	59.4	59.4	59.4	59.5	59.6	59.6	59.6	59.6	57.3	59.5	59.5	59.5	59.5
	dm_clm_sun	59.8	59.8	59.8	59.8	59.8	59.7	59.8	59.8	59.8	59.8	59.3	59.6	59.6	59.6	59.6
	dm_clm_cld	59.7	59.7	59.7	59.7	59.7	59.8	59.8	59.8	59.8	59.8	59.6	59.7	59.7	59.7	59.7
	dp_wnd_sun	59.7	59.7	59.7	59.7	59.7	59.6	59.6	59.6	59.6	59.6	xx	59.4	59.4	59.5	59.5
	dp_wnd_cld	59.8	59.8	59.8	59.8	59.8	59.7	59.8	59.8	59.8	59.8	59.7	59.9	59.9	59.9	59.9
	dp_clm_sun	59.7	59.7	59.7	59.7	59.7	59.8	59.8	59.8	59.8	59.8	59.5	59.6	59.6	59.6	59.6
	dp_clm_cld	59.7	59.7	59.7	59.7	59.7	59.7	59.7	59.7	59.7	59.7	58.6	58.7	59.0	59.1	59.1
	p_wnd	59.7	59.8	59.8	59.8	59.8	59.7	59.8	59.8	59.8	59.8	59.5	59.7	59.7	59.8	59.8
	p_clm	59.6	59.7	59.7	59.7	59.7	59.6	59.7	59.7	59.7	59.7	59.3	59.4	59.4	59.5	59.5

Table 8-10 shows the results for contingencies related to the 69/23 kV transformers. BESS support of 10 MW or more can prevent load shedding and potential collapse. The Waiinu 69/23

kV outage with the 2019_m_wnd dispatch resulted in system collapse without BESS support. This simulation was a cascading outage where the wind generation tripped offline due to over-frequency, and resulted in system collapse. The other highlighted cells were due to PV tripping similar to what was seen in Figure 8-3.

Table 8-11: Fault Instability Results 2 of 3

Outage	Dispatch	2014					2016					2019				
		0	5	10	15	21	0	5	10	15	21	0	5	10	15	21
K a n a h a - P u u n e n e	m_wnd	59.5	59.5	59.5	59.5	59.5	58.0	58.1	58.2	58.2	58.2	57.2	58.9	58.9	58.9	58.9
	m_clm	59.4	59.6	59.6	59.6	59.6	59.4	59.6	59.6	59.6	59.6	58.9	59.1	59.2	59.2	59.2
	dm_wnd_sun	57.9	58.1	58.3	58.5	58.6	xx	xx	xx	xx	xx	xx	xx	xx	xx	xx
	dm_wnd_cld	58.8	58.8	58.8	58.8	58.9	58.4	58.5	58.5	58.5	58.6	57.9	58.0	58.1	58.2	58.3
	dm_clm_sun	57.7	58.0	58.3	58.4	58.6	xx	xx	55.5	56.8	57.4	xx	xx	xx	xx	xx
	dm_clm_cld	58.5	58.7	59.1	59.2	59.2	58.4	58.6	58.8	59.2	59.2	58.2	58.4	58.6	58.8	58.8
	dp_wnd_sun	58.3	58.5	58.6	58.6	59.1	xx	xx	xx	xx	xx	xx	xx	xx	xx	xx
	dp_wnd_cld	59.3	59.6	59.6	59.7	59.7	58.6	58.8	59.3	59.4	59.4	58.8	59.0	59.1	59.1	59.2
	dp_clm_sun	58.2	58.3	58.4	58.5	58.6	55.7	56.9	57.6	57.8	58.0	xx	xx	xx	xx	xx
	dp_clm_cld	58.6	58.8	59.1	59.2	59.3	58.5	58.6	58.9	59.1	59.1	57.9	58.0	58.1	58.2	58.3
	p_wnd	59.4	59.6	59.7	59.7	59.7	59.4	59.6	59.7	59.7	59.7	58.4	58.7	59.3	59.4	59.5
	p_clm	58.7	59.1	59.3	59.4	59.4	58.7	59.1	59.3	59.4	59.4	xx	xx	xx	xx	xx
L a h a i n a - L a h a l u n a	m_wnd	59.4	59.4	59.4	59.4	59.4	59.3	59.3	59.3	59.3	59.4	57.3	58.8	58.8	58.9	59.0
	m_clm	59.6	59.7	59.7	59.7	59.7	59.5	59.6	59.6	59.6	59.6	59.3	59.5	59.5	59.5	59.5
	dm_wnd_sun	58.2	58.4	58.6	58.9	59.0	xx	xx	57.0	57.6	57.8	xx	xx	xx	xx	xx
	dm_wnd_cld	59.0	59.0	59.0	59.1	59.1	59.2	59.3	59.3	59.3	59.3	57.9	58.1	58.3	58.5	58.6
	dm_clm_sun	59.3	59.5	59.5	59.5	59.5	59.6	59.7	59.7	59.7	59.7	xx	xx	xx	xx	xx
	dm_clm_cld	58.6	58.8	59.1	59.2	59.2	59.2	59.5	59.5	59.5	59.5	58.4	58.6	58.8	59.0	59.0
	dp_wnd_sun	59.3	59.6	59.6	59.4	59.6	xx	xx	57.5	57.8	58.0	xx	xx	xx	xx	xx
	dp_wnd_cld	59.5	59.7	59.7	59.7	59.7	59.1	59.5	59.5	59.6	59.6	59.6	59.7	59.7	59.8	59.8
	dp_clm_sun	58.0	58.2	58.2	58.4	58.5	59.4	59.5	59.6	59.6	59.6	57.9	58.1	58.2	58.4	58.5
	dp_clm_cld	58.6	58.7	59.1	59.2	59.2	58.5	58.6	58.8	59.0	59.0	58.4	58.5	58.6	58.8	58.9
	p_wnd	59.4	59.6	59.7	59.7	59.7	59.4	59.6	59.6	59.6	59.6	59.2	59.4	59.4	59.5	59.5
	p_clm	58.7	59.1	59.3	59.4	59.4	58.7	59.0	59.3	59.3	59.4	58.8	59.1	59.1	59.2	59.2
M a l a e a - K i h e i	m_wnd	59.6	59.6	59.6	59.6	59.6	59.3	59.3	59.4	59.4	59.4	58.7	59.0	59.0	59.0	59.0
	m_clm	59.6	59.6	59.6	59.6	59.6	59.5	59.5	59.5	59.6	59.6	59.1	59.2	59.4	59.4	59.4
	dm_wnd_sun	59.4	59.4	59.4	59.5	59.5	58.4	58.6	58.9	59.3	59.3	xx	xx	xx	xx	xx
	dm_wnd_cld	59.4	59.4	59.4	59.4	59.4	59.6	59.6	59.6	59.6	59.6	57.9	58.3	58.3	58.4	58.5
	dm_clm_sun	58.1	58.2	58.4	58.5	58.8	58.4	58.6	58.8	59.1	59.1	xx	xx	xx	xx	xx
	dm_clm_cld	58.7	59.0	59.1	59.2	59.2	58.5	58.6	58.9	59.1	59.1	59.2	59.3	59.4	59.4	59.4
	dp_wnd_sun	59.2	59.5	59.5	59.5	59.5	58.5	58.6	59.0	59.3	59.3	xx	xx	xx	xx	xx
	dp_wnd_cld	59.3	59.4	59.5	59.5	59.6	58.7	59.1	59.3	59.3	59.3	59.5	59.6	59.6	59.7	59.7
	dp_clm_sun	58.2	58.3	58.4	58.5	58.6	57.6	57.7	57.9	58.1	58.2	xx	xx	xx	xx	56.8
	dp_clm_cld	58.7	58.9	59.1	59.1	59.1	58.6	58.7	58.9	59.0	59.0	58.3	58.4	58.5	58.6	58.7
	p_wnd	59.5	59.6	59.6	59.6	59.6	59.5	59.5	59.6	59.6	59.6	59.1	59.1	59.2	59.2	59.3
	p_clm	59.1	59.2	59.2	59.3	59.3	xx	xx	xx	xx	xx	xx	xx	xx	xx	xx

Table 8-11 shows the stability results for the Kanaha-Puunene, Lahaina-Lahaluna, and Maalaea-Kihe i outages. In general, the contingencies run with the 2019 sunny cases resulted in system collapse due to the PV tripping. These faults were cleared in 9 cycles at the near end and 22 cycles at the far end.

The BESS support was able to prevent system collapse in some of the 2016 cases. BESS support up to 21 MW is insufficient to prevent system collapse for the 2016_dm_wnd_sun cases with the Kanaha-Puunene outage with the original clearing times. At the 2019 PV levels, even 21 MW of BESS support was insufficient to prevent collapse for the loss of the PV. These system collapse issues seen in 2016 and 2019 years are further discussed in the Instability Sensitivity Cases section of this report.

The 2019 minimum and peak load cases were unstable even without the PV tripping. The 2019 peak cases had some units lose synchronism with the rest of the grid. These outages will be discussed further in the Critical Clearing Times section of this report. The 2019 minimum cases were highly oscillatory for the Lahaina-Lahaluna and Kanaha-Puunene contingencies. With the limited number of conventional units online and no BESS support, the DTCC1 is unable to control the frequency following the line fault. The frequency eventually exceeds the wind farm over-frequency protection settings and the AWF plant trips resulting in a low system frequency and risk of system collapse.

Table 8-12: Fault Instability Results 3 of 3

Outage	Dispatch	2014					2016					2019				
		0	5	10	15	21	0	5	10	15	21	0	5	10	15	21
Maalaea-KWP	m_wnd	59.2	59.2	59.2	59.2	59.2	58.9	59.0	59.1	59.1	59.1	58.1	58.6	58.7	58.8	58.8
	m_clm	59.2	59.3	59.4	59.4	59.4	59.2	59.3	59.4	59.4	59.3	58.9	59.1	59.2	59.2	59.2
	dm_wnd_sun	59.1	59.2	59.2	59.2	59.2	xx	57.2	57.7	57.9	58.1	xx	xx	xx	xx	xx
	dm_wnd_cld	58.9	58.9	58.8	58.9	58.9	59.2	59.2	59.2	59.2	59.2	57.8	58.0	58.1	58.2	58.3
	dm_clm_sun	57.7	57.9	58.1	58.2	58.4	58.8	59.1	59.3	59.3	59.3	xx	xx	xx	xx	xx
	dm_clm_cld	58.3	58.4	58.5	58.7	58.8	58.1	58.3	58.4	58.5	58.7	58.9	59.0	59.1	59.3	59.3
	dp_wnd_sun	58.7	59.3	59.4	59.4	59.4	57.6	57.8	58.1	58.9	59.0	xx	xx	xx	xx	xx
	dp_wnd_cld	59.1	59.3	59.4	59.4	59.4	58.3	58.5	58.6	58.9	58.9	59.2	59.4	59.5	59.4	59.4
	dp_clm_sun	57.7	57.9	58.0	58.1	58.2	xx	57.4	57.6	57.8	57.9	xx	xx	xx	xx	xx
	dp_clm_cld	58.3	58.5	58.5	58.7	58.8	58.3	58.3	58.4	58.5	58.6	58.1	58.1	58.2	58.3	58.4
	p_wnd	59.1	59.4	59.4	59.5	59.5	59.1	59.3	59.3	59.4	59.4	58.9	58.9	59.0	59.2	59.1
	p_clm	58.5	58.6	58.7	58.9	59.0	xx	xx	xx	xx	xx	xx	xx	xx	xx	xx
Maalaea-Lahaluna	m_wnd	59.4	59.4	59.4	59.4	59.4	59.2	59.3	59.3	59.3	59.3	58.3	58.9	59.0	59.0	59.0
	m_clm	59.2	59.3	59.4	59.4	59.4	59.2	59.3	59.4	59.4	59.4	59.0	59.2	59.3	59.2	59.2
	dm_wnd_sun	59.3	59.3	59.3	59.3	59.3	57.6	58.0	58.3	58.5	58.8	xx	xx	xx	xx	xx
	dm_wnd_cld	59.1	59.1	59.1	59.1	59.1	59.4	59.4	59.4	59.4	59.4	57.4	59.0	59.0	59.0	59.0
	dm_clm_sun	57.7	57.9	58.1	58.2	58.4	58.8	59.1	59.3	59.3	59.3	xx	xx	xx	xx	xx
	dm_clm_cld	58.3	58.4	58.5	58.8	58.9	58.1	58.3	58.4	58.5	58.8	58.9	59.0	59.2	59.3	59.3
	dp_wnd_sun	58.7	59.3	59.4	59.4	59.4	57.9	58.2	58.3	59.3	59.3	xx	xx	58.2	58.4	58.5
	dp_wnd_cld	59.0	59.2	59.4	59.4	59.4	58.5	58.6	58.9	59.0	59.0	59.1	59.2	59.3	59.4	59.4
	dp_clm_sun	57.8	57.9	58.0	58.1	58.2	xx	57.4	57.6	57.8	57.9	xx	xx	xx	xx	xx
	dp_clm_cld	58.4	58.5	58.6	58.8	58.9	58.3	58.3	58.5	58.5	58.6	58.1	58.2	58.3	58.3	58.5
	p_wnd	59.1	59.4	59.4	59.5	59.5	59.1	59.3	59.3	59.4	59.4	58.9	59.0	59.1	59.2	59.1
	p_clm	58.5	58.6	58.7	58.9	59.0	xx	xx	xx	xx	xx	xx	xx	xx	xx	xx
Maalaea-Waiinu	m_wnd	59.7	59.8	59.8	59.8	59.8	59.7	59.7	59.8	59.8	59.7	58.5	59.0	59.0	59.1	59.1
	m_clm	59.2	59.3	59.4	59.4	59.4	59.1	59.3	59.3	59.4	59.4	58.9	59.0	59.2	59.2	59.2
	dm_wnd_sun	59.4	59.6	59.6	59.6	59.6	58.6	59.3	59.4	59.5	59.5	xx	xx	xx	xx	xx
	dm_wnd_cld	59.5	59.7	59.6	59.7	59.7	59.3	59.6	59.6	59.7	59.7	58.1	58.2	58.3	58.3	58.4
	dm_clm_sun	57.9	58.2	58.3	58.5	58.7	58.6	59.0	59.2	59.3	59.3	xx	xx	xx	xx	xx
	dm_clm_cld	58.4	58.5	58.7	58.9	59.0	58.2	58.3	58.4	58.5	58.8	58.9	59.0	59.1	59.3	59.3
	dp_wnd_sun	58.7	59.3	59.4	59.5	59.4	57.8	58.1	58.3	59.4	59.4	xx	xx	xx	xx	xx
	dp_wnd_cld	58.8	59.1	59.2	59.3	59.3	58.2	58.4	58.5	58.8	58.9	59.0	59.1	59.3	59.3	59.3
	dp_clm_sun	57.8	57.9	58.1	58.2	58.3	xx	57.4	58.0	57.6	57.8	xx	xx	xx	xx	xx
	dp_clm_cld	58.4	58.5	58.7	58.9	59.0	58.3	58.4	58.5	58.6	58.7	57.9	58.0	58.1	58.2	58.3
	p_wnd	59.0	59.2	59.4	59.4	59.5	59.0	59.2	59.3	59.4	59.4	58.6	58.8	58.9	58.9	58.8
	p_clm	58.6	58.6	58.9	59.1	59.1	xx	xx	xx	xx	xx	xx	xx	xx	xx	xx

Table 8-12 shows the stability results for the Maalaea-KWP, Maalaea-Lahaluna, and Maalaea-Waiinu outages. In general, the contingencies run with the 2019 sunny cases resulted in system collapse due to the PV tripping with the original clearing times. The other cases that had issues were 2019 minimum load cases and the 2019 peak cases that had some units lose synchronism with the rest of the grid. The simulations that lose synchronism will be discussed further in the Critical Clearing Times section of this report. Again, the BESS support was able to prevent system collapse in the 2016 cases with the original clearing times. However, at the 2019 PV levels, the BESS support was insufficient to prevent collapse for the loss of the PV. These system collapse issues seen in 2016 and 2019 years is further discussed in the Instability Sensitivity Cases section of this report.

The 2019 minimum load, 2016 peak, and 2019 peak cases were unstable even without the PV tripping with the original clearing times. The 2016 peak and 2019 peak cases had some units lose synchronism with the rest of the grid. These outages will be discussed further in the Critical Clearing Times section of this report. The 2019 minimum case was highly oscillatory for the Maalaea-KWP contingency. With the limited number of conventional units online and no BESS support, the DTCC1 is unable to control the frequency. The frequency eventually exceeds the wind farm over-frequency protection settings and the AWF plant trips resulting in a low system frequency and risk of system collapse.

In general, the BESS support can reduce the number of stages of load shedding needed to arrest system frequency decay for unit trip contingencies. Without BESS support, the system is at risk of system collapse for a single generating unit outage. Even with 21 MW of BESS support, two stages of load shedding is shed due to the loss of the KWP plant during sunny conditions in 2019.

The BESS support was largely ineffective in preventing the system collapse for line fault simulations even with 21 MW of BESS support from AWF and KWP-II BESS systems with the original clearing times. For simulations that remained stable, the BESS support can reduce the number of stages of load shed. During the fault, the BESS systems provide little benefit since they provided limited fault current. Without significant voltage support, the PV can trip offline due to under-voltage protection and cause the system to collapse in future cases.

8.3 Instability Sensitivity Cases

We investigated the impact of several mitigation measures on the transient stability of the system. The mitigation measures studied included:

1. Faster clearing times
 - a. Clearing times were reduced to 5 cycles at near end, and 7 cycles at far end through the use of a pilot protection scheme
2. Enforcing extended ride through for the PV generation
 - a. 50% voltage tripping time-out extended from 0.167 seconds to 0.50 seconds
 - b. 60.5 Hz tripping time-out extended from 0.167 seconds to 1.0 seconds
 - c. Time-out times were only extended for PV that is installed after 2014
3. Increasing amount of load in UFLS stages
 - a. Added Wailea A feeder @ 58.7 Hz (Bus 125,'1')
 - b. Added Napili '1' feeder @ 58.5 Hz (Bus 129,'1')
 - c. Added Lahaina1 '1' feeder @ 58.5 Hz (Bus 134,'1')
 - d. Added Mahinahina '1' feeder @ 58.0 Hz (Bus 150,'1')
 - e. Added Wailea B '1' feeder @ 58.0 Hz (Bus 225,'1')

The results of these sensitivity cases are attached in Appendix C.

8.3.1 Pilot Protection

Reducing the clearing times to 5 cycles at the near end and 7 cycles at the far end of a line significantly reduced the number of simulations that resulted in system collapse. There were no significant differences between the results for the two transmission configurations in case year 2019. The system collapse typically occurred for the 2019 day peak cases with high levels of

solar generation. Table 8-13 below shows the contingencies and cases that resulted in system instability.

Table 8-13: Unstable Cases with Pilot Protection

		2014	2016	2019	2019			2014	2016	2019	2019
					Alt						Alt
Outage	Case	Minimum Freq.				Outage	Minimum Freq.				
Maalaea -	m_wnd	59.8	59.5	59.7	59.6	Maalaea -	59.9	59.7	59.8	59.8	
	m_clm	59.7	59.7	59.6	59.6		59.9	59.8	59.8	59.8	
	dm_wnd_sun	59.8	60.0	59.8	59.8		60.0	60.0	59.9	57.2	
	dm_wnd_cld	59.7	59.8	59.2	59.9		59.8	60.0	59.3	60.0	
	dm_clm_sun	59.7	59.9	59.6	59.6		59.6	60.0	59.5	xx	
	dm_clm_cld	59.5	59.6	59.4	59.7		59.5	59.5	59.5	59.2	
	dp_wnd_sun	59.9	60.0	xx	60.0		60.0	60.0	57.5	xx	
	dp_wnd_cld	59.8	59.8	59.8	59.9		59.9	59.7	59.9	60.0	
	dp_clm_sun	59.1	59.7	xx	xx		58.9	58.6	xx	xx	
	dp_clm_cld	59.4	59.2	59.0	59.0		59.6	59.4	59.3	59.4	
	p_wnd	59.8	60.0	59.7	60.0		60.0	60.0	60.0	60.0	
	p_clm	59.5	59.6	59.4	59.6		59.8	59.9	59.6	59.9	
	Maalaea - KWP	m_wnd	59.8	59.5	59.6		59.6	Maalaea - KWP	59.7	59.6	59.1
m_clm		59.7	59.7	59.6	59.6	59.8	59.8		59.7	59.6	
dm_wnd_sun		59.8	60.0	59.8	59.8	59.7	59.6		59.6	59.6	
dm_wnd_cld		59.6	59.8	59.2	59.9	59.6	59.7		59.5	59.5	
dm_clm_sun		59.7	59.9	59.6	59.6	59.8	59.7		59.5	59.5	
dm_clm_cld		59.5	59.6	59.4	59.7	59.7	59.8		59.7	59.7	
dp_wnd_sun		59.9	59.9	xx	60.0	59.8	59.7		59.5	59.5	
dp_wnd_cld		59.8	59.8	59.8	59.9	59.8	59.8		59.8	59.8	
dp_clm_sun		59.1	59.7	xx	xx	59.7	59.8		59.6	59.6	
dp_clm_cld		59.4	59.3	59.0	59.0	59.7	59.7		59.5	58.9	
p_wnd	59.9	60.0	59.8	60.0	59.8	59.8	59.7	59.8			
p_clm	59.5	59.6	59.4	59.6	59.7	59.7	59.4	59.3			
Maalaea -	m_wnd	59.9	59.6	59.7	59.7	Maalaea -	59.5	59.5	59.1	59.1	
	m_clm	59.7	59.7	59.6	59.6		59.8	59.8	59.7	59.7	
	dm_wnd_sun	59.9	60.0	59.8	59.8		59.5	59.7	59.6	59.6	
	dm_wnd_cld	59.8	59.9	59.2	59.9		59.5	59.6	59.4	59.5	
	dm_clm_sun	59.7	59.9	59.6	59.6		59.8	59.8	59.5	59.6	
	dm_clm_cld	59.5	59.5	59.4	59.1		59.7	59.8	59.8	59.8	
	dp_wnd_sun	59.9	60.0	xx	60.0		59.7	59.6	59.4	59.5	
	dp_wnd_cld	59.8	59.8	59.8	59.9		59.8	59.8	59.8	59.8	
	dp_clm_sun	59.1	59.2	xx	xx		59.7	59.8	59.7	59.7	
	dp_clm_cld	59.4	59.2	59.0	59.0		59.7	59.7	59.7	59.7	
p_wnd	59.8	60.0	59.7	60.0	59.8	59.8	59.8	59.8			
p_clm	59.6	59.7	59.4	59.6	59.7	59.7	59.6	59.6			

The faults between Kanaha – Puunene and Lahaina – Lahaluna no longer caused system collapse. System instabilities only occurred for the faults that were near the Maalaea power plant with the faster clearing times used in this sensitivity analysis. When the fault clearing times were reduced, the voltage recovered quickly enough to avoid the under-voltage tripping of the PV, but the fault was on the system long enough for the Maalaea generation to speed up beyond 60.5 Hz. When the frequency was above 60.5 Hz for 0.167 seconds, the PV tripped, and caused the system to collapse. Faults that were further away from the Maalaea power plant did not cause the units to accelerate beyond 60.5 Hz, and therefore did not lose the PV

generation. The Maalaea – Kihei fault with the dm_wnd_sun dispatch ended with all stages of load shedding, but remained stable because most of the PV remained connected to the system. About 32 MW tripped on over-frequency, and the load shedding system was able to arrest the frequency decay before the remainder of the PV would have tripped at 57.0 Hz. From these results, it appears that only decreasing the clearing times through protection upgrades would not prevent system instability on its own.

8.3.2 Extended Ride-Through for PV

We also reviewed the impact that a change to the settings specified in Rule 14H would have on the system response to the disturbances. Specifically, we assumed that all PV installed after 2014 would have the new extended ride-through Rule 14H settings, and the PV installed in 2014 would follow the current Rule 14H settings. The extended ride-through settings for these simulations were:

- Under-voltage setting at 0.5 p.u. set with time delay of 0.5 seconds
- Over-frequency setting at 60.5 Hz set with a time delay of 1.0 seconds
- All other settings remained unchanged

Each of the unit trip and line fault simulations were re-run with these updated settings. Several contingencies and dispatch cases still had unstable results as shown in Table 8-14 using the original clearing times.

Table 8-14: Unstable Simulations with Extended Ride-Through for PV

		2014	2016	2019	2019		2014	2016	2019	2019
					Alt					Alt
Outage	Case	Minimum Freq.				Outage	Minimum Freq.			
M a a l a e a u - a	m_wnd	59.3	59.5	59.8	59.9	M a a l a e a i - a	59.6	59.6	59.7	59.9
	m_clm	59.5	59.4	59.6	59.6		59.6	59.6	59.6	59.7
	dm_wnd_sun	58.9	59.5	xx	xx		59.5	59.7	57.5	57.6
	dm_wnd_cld	59.1	59.5	60.0	59.9		59.5	59.8	59.8	59.9
	dm_clm_sun	58.2	59.6	xx	57.4		58.5	59.5	57.1	58.8
	dm_clm_cld	58.8	59.0	59.4	59.5		59.2	59.3	59.4	59.7
	dp_wnd_sun	59.4	59.5	58.9	58.9		59.6	59.7	59.1	59.1
	dp_wnd_cld	59.4	59.2	59.9	59.2		59.6	59.5	60.0	59.6
	dp_clm_sun	58.1	58.1	58.3	58.3		58.5	58.3	58.0	58.7
	dp_clm_cld	58.8	58.8	58.8	58.8		59.2	59.2	58.8	59.1
	p_wnd	59.6	59.5	59.2	59.4		59.8	59.7	59.3	59.7
p_clm	59.0	59.1	58.9	59.0	59.4	59.5	59.1	59.3		
M a a l a e a - K W P	m_wnd	59.1	59.2	59.5	59.8	K P a u n a n e - e	59.4	58.6	58.9	59.2
	m_clm	59.5	59.4	59.6	59.6		59.6	59.6	59.2	58.7
	dm_wnd_sun	58.4	59.2	xx	xx		58.3	58.1	xx	xx
	dm_wnd_cld	58.9	59.3	59.8	60.0		59.3	59.2	58.8	58.6
	dm_clm_sun	58.2	59.6	xx	57.2		58.3	58.0	xx	xx
	dm_clm_cld	58.8	58.9	59.4	59.5		59.1	59.1	58.9	58.4
	dp_wnd_sun	59.3	59.2	58.9	59.1		58.6	58.4	57.5	57.8
	dp_wnd_cld	59.4	59.2	59.9	59.2		59.6	59.3	59.3	58.6
	dp_clm_sun	58.1	58.2	58.3	58.4		58.4	58.6	57.3	56.8
	dp_clm_cld	58.8	58.8	58.8	58.8		59.2	59.0	58.3	xx
	p_wnd	59.6	59.5	59.2	59.4		59.7	59.7	59.4	xx
p_clm	59.0	59.1	58.8	59.0	59.3	59.3	58.4	xx		
M a W a a l i a i e n a u -	m_wnd	59.9	59.8	60.0	59.7	L L a a h h a a i l n u a n - a	59.2	59.4	58.9	59.2
	m_clm	59.5	59.4	59.5	59.4		59.7	59.6	59.4	59.5
	dm_wnd_sun	59.6	59.8	xx	xx		58.3	58.6	xx	xx
	dm_wnd_cld	59.6	59.7	59.7	59.7		59.2	59.5	59.1	59.1
	dm_clm_sun	58.5	59.6	xx	57.1		59.5	59.7	xx	xx
	dm_clm_cld	58.9	59.0	59.3	59.4		59.1	59.5	59.3	59.3
	dp_wnd_sun	59.4	59.6	58.9	58.8		59.4	58.6	57.7	57.9
	dp_wnd_cld	59.5	59.2	59.7	59.0		59.6	59.5	59.8	59.7
	dp_clm_sun	58.2	58.2	58.1	57.3		58.3	59.6	58.1	58.0
	dp_clm_cld	58.9	58.9	58.5	58.4		59.1	59.1	59.1	59.1
	p_wnd	59.5	59.5	59.0	59.0		59.6	59.6	59.5	59.4
p_clm	59.1	59.2	58.7	58.8	59.3	59.3	59.1	59.1		

For the cases with high levels of solar generation, the PV installed by 2014 trips offline at a voltage of 0.5 p.u. With 47 MW of PV capacity at an 85% capacity factor, this corresponds to a loss of approximately 40 MW of PV generation for this under-voltage trip condition. The UFLS is unable to restore the system frequency before the frequency drops to 57.0 Hz when the remainder of the PV trips, and the system collapses. The 2014 and 2016 years survive these events because the net load on each UFLS stage is larger in those years than in 2019.

The simulations that were unstable without high levels of PV generation (peak or cloudy cases) were unstable due to loss of synchronism of the 2.5 MW diesel units or the loss of synchronism of the Waena units. These simulations will be further discussed in the Critical Clearing Times

section of this report. The alternate transmission configuration had minimal impact on the simulation results for these sensitivity cases.

8.3.3 Increasing Number of Circuits on UFLS

We reviewed the impact that a change to the UFLS scheme would have on the system stability. The updated UFLS scheme still resulted in simulations that were unstable in the 2016 and 2019 years. Table 8-15 shows minimum frequencies for the contingencies and dispatches with additional circuits on the UFLS scheme. These results are for simulations with the original clearing times.

Table 8-15: Simulation Results with Additional Circuits on UFLS

		2014	2016	2019	2019			2014	2016	2019	2019
					Alt						Alt
Outage	Case	Minimum Freq.				Outage	Minimum Freq.				
M a a l a e u a	m_wnd	59.2	59.3	59.6	60.0	M a a l a e i	59.6	59.6	59.6	59.9	
	m_clm	59.5	59.5	59.7	59.7		59.7	59.7	59.7	59.8	
	dm_wnd_sun	58.9	58.8	xx	xx		59.5	59.5	xx	xx	
	dm_wnd_cld	59.2	59.6	60.0	58.4		59.6	59.8	59.8	58.9	
	dm_clm_sun	58.4	59.6	xx	xx		58.8	59.3	xx	xx	
	dm_clm_cld	59.0	58.9	59.2	59.2		59.4	59.2	59.4	59.5	
	dp_wnd_sun	59.5	59.6	xx	xx		59.6	59.6	xx	57.4	
	dp_wnd_cld	59.5	58.2	58.9	59.6		59.6	58.4	59.3	59.8	
	dp_clm_sun	58.3	57.6	56.5	56.5		58.8	58.3	xx	57.4	
	dp_clm_cld	59.1	59.0	58.7	58.8		59.4	59.4	58.9	59.2	
	p_wnd	59.5	59.4	58.3	59.2		59.7	59.7	58.4	59.5	
	p_clm	59.4	59.4	59.1	59.2		59.7	59.6	59.3	59.6	
M a a l a e a - K W P	m_wnd	59.1	59.1	59.4	59.7	K P a u n a h a n e	59.3	58.4	58.9	59.1	
	m_clm	59.6	59.5	59.7	59.7		59.6	59.6	59.2	58.6	
	dm_wnd_sun	58.4	58.2	xx	xx		58.4	xx	xx	xx	
	dm_wnd_cld	59.0	59.4	59.6	57.8		58.9	58.6	58.1	58.2	
	dm_clm_sun	58.4	59.6	xx	xx		58.3	57.3	xx	xx	
	dm_clm_cld	59.0	58.8	59.2	59.2		59.1	59.0	58.6	58.1	
	dp_wnd_sun	59.5	59.3	xx	xx		58.6	xx	xx	xx	
	dp_wnd_cld	59.5	58.2	59.0	59.6		59.6	59.4	59.1	58.5	
	dp_clm_sun	58.3	57.6	56.5	56.6		58.4	57.8	56.9	56.5	
	dp_clm_cld	59.0	59.0	58.6	58.8		59.2	59.0	58.2	xx	
	p_wnd	59.5	59.5	58.3	59.3		59.7	59.7	xx	xx	
	p_clm	59.4	59.3	59.1	59.2		59.3	59.3	xx	xx	
M a W a a l i e n a u	m_wnd	59.9	59.7	59.8	59.8	L L a a h h a a i l n u a n - a	59.2	59.3	58.9	58.9	
	m_clm	59.5	59.5	59.5	59.5		59.7	59.6	59.4	59.4	
	dm_wnd_sun	59.6	59.8	xx	xx		58.3	57.7	xx	xx	
	dm_wnd_cld	59.8	59.8	59.7	57.8		59.1	59.3	58.3	58.3	
	dm_clm_sun	58.8	59.6	xx	xx		59.5	59.7	xx	xx	
	dm_clm_cld	59.2	58.9	59.1	59.2		59.1	59.5	58.8	58.8	
	dp_wnd_sun	59.3	59.6	56.7	xx		59.6	57.9	xx	xx	
	dp_wnd_cld	59.4	58.2	58.9	59.5		59.7	59.5	59.8	59.8	
	dp_clm_sun	58.4	57.6	56.7	56.9		58.3	59.6	58.2	58.6	
	dp_clm_cld	59.1	59.1	58.4	58.6		59.1	58.8	58.6	58.6	
	p_wnd	59.5	59.4	58.2	58.9		59.7	59.6	59.5	59.4	
	p_clm	59.4	59.4	59.0	59.1		59.3	59.3	59.1	59.1	

The UFLS scheme did very little to resolve the instability issues seen in the original cases. The majority of the line faults with high solar levels still resulted in system instability. Even with the added UFLS circuits, the loss of the PV generation was too large to survive.

We also ran unit trip simulations with additional circuits on the UFLS system. The additional circuits on the UFLS scheme only changed the KWP trip results. A comparison between the original cases and the sensitivity cases with additional feeders in the UFLS scheme is shown below in Table 8-16.

Table 8-16: KWP Trip Comparison

		2014	2016	2019	2019	2014	2016	2019	2019
		Original Cases				Extra UFLS			
		Alt				Alt			
Outage	Case	Minimum Freq.				Minimum Freq.			
K W P	m_wnd	58.6	59.1	57.8	57.8	58.6	59.1	57.8	57.8
	m_clm	59.9	59.9	59.9	59.9	59.9	59.9	59.9	59.9
	dm_wnd_sun	58.3	58.7	59.3	59.3	58.4	58.7	59.3	59.3
	dm_wnd_cld	58.6	58.7	58.1	58.1	58.6	58.7	58.1	58.0
	dm_clm_sun	59.9	59.9	59.8	59.8	59.9	59.9	59.8	59.8
	dm_clm_cld	59.9	59.9	59.9	59.9	59.9	59.9	59.9	59.9
	dp_wnd_sun	59.0	58.5	58.0	58.0	59.0	58.5	58.1	xx
	dp_wnd_cld	59.1	58.9	59.1	59.1	59.1	58.9	59.1	59.1
	dp_clm_sun	59.9	59.9	59.9	59.9	60.0	59.9	59.9	59.9
	dp_clm_cld	60.0	60.0	60.0	60.0	60.0	60.0	60.0	60.0
	p_wnd	59.2	59.2	58.6	58.6	59.2	59.2	58.6	58.6
	p_clm	60.0	60.0	60.0	60.0	60.0	60.0	60.0	60.0

The differences between the original and sensitivity cases are:

- 2019_m_wnd – three vs. two stages of load shedding
- 2016_dp_wnd_sun – two vs. one stage of load shedding
- 2019_dp_wnd_sun (alternate transmission) – two stages vs. system collapse

The trip of the KWP plant resulted in a system collapse in year 2019 with the 'dp_wnd_sun' dispatch case even though this contingency was stable with no changes to the UFLS scheme. In this event, after the KWP plant was lost, UFLS responded by shedding the first two stages of load shed. However, this loss of load caused the frequency to rise above the 60.5 Hz trip setting for the PV resulting in a system collapse when all the PV generation trips. This event illustrates yet another way that the PV trip settings are problematic for system stability. The frequency dropped below 60.5 Hz quickly enough to prevent the PV tripping with the preferred transmission configuration, but was within a few cycles of system collapse.

8.3.4 Combined Sensitivity Cases

Since none of the original sensitivity cases resolved all of the system instabilities, we studied the improvements that could come from implementing multiple mitigation strategies. When combining the change to the UFLS scheme and implementing an extended ride-through for future installed PV, the impact on system stability was significant. Table 8-17 shows the minimum frequencies for the contingencies and dispatch cases for this combined sensitivity case.

Table 8-17: Simulation Results with UFLS Change and Extended Ride-Through (Unit Trips)

		2014	2016	2019	2019			2014	2016	2019	2019
Original Cases					Alt	Extra UFLS					Alt
Outage	Case	Minimum Freq.				Outage	Minimum Freq.				
M 1 4	m_wnd	59.5	59.7	59.3	59.3	K W P	58.6	59.1	57.8	57.8	
	m_clm	59.5	59.5	59.3	59.3		59.9	59.9	59.9	59.9	
	dm_wnd_sun	59.5	59.7	59.4	59.4		58.4	58.7	59.3	59.3	
	dm_wnd_cld	59.5	59.7	59.3	59.3		58.6	58.7	58.1	58.1	
	dm_clm_sun	59.5	59.7	59.3	59.2		59.9	59.9	59.8	59.8	
	dm_clm_cld	59.4	59.4	59.5	59.5		59.9	59.9	59.9	59.9	
	dp_wnd_sun	59.6	59.6	59.5	59.5		59.0	58.5	58.1	57.4	
	dp_wnd_cld	59.6	59.4	59.5	59.5		59.1	58.9	59.1	59.1	
	dp_clm_sun	59.6	59.6	59.6	59.6		59.9	59.9	59.9	59.9	
	dp_clm_cld	59.5	59.5	59.5	59.5		60.0	60.0	60.0	60.0	
	p_wnd	59.5	59.5	58.8	58.9		59.2	59.2	58.6	58.6	
	p_clm	59.3	59.2	58.7	58.7		60.0	60.0	60.0	60.0	

With extended ride-through, and additional circuits added to the UFLS scheme, all unit trip simulations were stable, but the loss of KWP would activate all three stages of load shedding.

Table 8-18: Simulation Results with UFLS Change and Extended Ride-Through (Line Faults)

		2014	2016	2019	2019			2014	2016	2019	2019
					Alt						Alt
Outage	Case	Minimum Freq.				Outage	Minimum Freq.				
M a a l a e u - a	m_wnd	59.3	59.5	59.9	59.1	M a a l a e i - a	59.7	59.6	59.9	59.6	
	m_clm	59.5	59.5	59.5	59.7		59.7	59.7	59.6	59.8	
	dm_wnd_sun	59.0	59.5	57.7	57.7		59.6	59.8	58.1	58.3	
	dm_wnd_cld	59.5	59.5	59.3	60.0		59.1	59.8	59.2	59.6	
	dm_clm_sun	58.4	59.8	57.7	58.9		58.8	59.7	58.1	59.3	
	dm_clm_cld	59.0	59.2	59.6	59.6		59.4	59.4	59.6	59.7	
	dp_wnd_sun	59.4	59.7	59.6	59.3		59.6	60.0	58.6	59.8	
	dp_wnd_cld	59.4	59.4	59.4	59.5		59.6	59.6	59.5	59.7	
	dp_clm_sun	58.3	58.4	58.5	58.9		58.8	58.6	58.3	59.1	
	dp_clm_cld	59.2	59.2	59.0	59.1		59.5	59.5	58.9	59.2	
	p_wnd	59.6	59.1	59.3	58.8		59.8	59.4	59.4	59.2	
	p_clm	59.4	59.6	59.1	59.2		59.7	59.9	59.3	59.6	
M a a l a e - K W P	m_wnd	59.1	59.3	59.7	59.1	K P a u n a n e - e	59.4	58.6	58.9	59.2	
	m_clm	59.5	59.5	59.6	59.7		59.6	59.6	59.2	58.7	
	dm_wnd_sun	58.8	59.2	57.7	57.8		58.4	58.1	57.1	57.0	
	dm_wnd_cld	59.3	59.3	59.3	60.0		59.3	59.2	58.8	58.6	
	dm_clm_sun	58.4	59.8	57.7	58.8		58.3	58.0	57.0	56.9	
	dm_clm_cld	59.0	59.1	59.6	59.6		59.1	59.1	58.9	58.4	
	dp_wnd_sun	59.5	59.3	59.6	59.3		58.6	58.4	57.4	57.4	
	dp_wnd_cld	59.4	59.4	59.4	59.5		59.6	59.3	59.3	58.6	
	dp_clm_sun	58.3	58.4	58.6	58.9		58.5	58.6	57.5	57.0	
	dp_clm_cld	59.2	59.2	59.0	59.1		59.2	59.0	58.3	xx	
	p_wnd	59.6	59.1	59.3	58.8		59.7	59.7	59.4	xx	
	p_clm	59.4	59.6	59.1	59.2		59.3	59.3	58.4	xx	
M a W a a l i e n a u -	m_wnd	59.9	59.9	60.0	58.9	L L a a h h a a i l n u a n - a	59.2	59.4	58.9	59.2	
	m_clm	59.5	59.5	59.4	59.5		59.7	59.6	59.4	59.5	
	dm_wnd_sun	59.9	60.0	57.7	57.7		58.3	58.6	57.1	57.1	
	dm_wnd_cld	58.7	59.7	58.9	60.0		59.2	59.5	59.1	59.1	
	dm_clm_sun	58.8	59.8	57.7	58.8		59.5	59.7	56.9	56.9	
	dm_clm_cld	59.2	59.2	59.5	59.7		59.1	59.5	59.3	59.3	
	dp_wnd_sun	59.5	59.6	58.2	58.4		59.4	58.6	57.4	57.4	
	dp_wnd_cld	59.5	59.4	59.2	59.3		59.6	59.5	59.8	59.7	
	dp_clm_sun	58.4	58.4	58.3	58.0		58.3	59.6	58.1	58.0	
	dp_clm_cld	59.3	59.3	58.7	58.7		59.1	59.1	59.1	59.1	
	p_wnd	59.5	59.1	59.1	58.4		59.6	59.6	59.5	59.4	
	p_clm	59.5	59.6	59.0	59.1		59.3	59.3	59.1	59.1	

None of the events resulted in a system collapse for the 2014, 2016, and 2019 preferred transmission configuration. Many of the simulations resulted in the loss of all stages of load shedding. Each line fault used the original clearing times of 9/22 cycles.

Several of the simulations resulted in the loss of synchronism of the units at Waena when using the alternate transmission configuration. If these units lose synchronism in real life, the units would be tripped most likely resulting in a system collapse. Since the Waena plant was dispatched at 51 MW for the 2019 peak case with no wind, the loss of this generation would be an extremely severe event for the system to survive. These events will be discussed in further detail in the Critical Clearing Times section of this report.

Finally, we studied cases using all three mitigation strategies: pilot protection, extended ride-through, and additional circuits on UFLS. The minimum frequency results are shown below in Table 8-19.

Table 8-19: Simulation Results with Pilot Protection, UFLS Change, and Extended Ride-Through

		2014	2016	2019	2019			2014	2016	2019	2019
					Alt						Alt
Outage	Case	Minimum Freq.				Outage	Minimum Freq.				
M a a l a e u - a	m_wnd	59.8	59.6	59.8	59.8	M a a l a e i - a	60.0	59.7	60.0	59.9	
	m_clm	59.8	59.8	59.9	59.7		60.0	60.0	60.0	59.9	
	dm_wnd_sun	59.9	60.0	59.6	58.2		58.9	58.9	57.4	57.5	
	dm_wnd_cld	59.7	59.8	59.8	59.6		59.9	60.0	59.2	59.5	
	dm_clm_sun	59.9	60.0	58.0	57.3		59.3	60.0	58.5	57.4	
	dm_clm_cld	59.6	59.6	59.5	59.5		59.7	59.8	59.7	59.7	
	dp_wnd_sun	59.9	60.0	59.3	58.9		60.0	59.1	59.0	59.3	
	dp_wnd_cld	59.8	60.0	60.0	59.8		59.9	60.0	60.0	59.9	
	dp_clm_sun	58.9	59.3	59.2	58.5		59.1	59.1	59.4	58.8	
	dp_clm_cld	59.5	59.5	59.5	59.5		59.7	59.8	59.7	59.7	
	p_wnd	59.8	60.0	59.8	60.0		60.0	60.0	60.0	60.0	
	p_clm	59.7	59.8	59.6	59.8		59.9	60.0	59.8	60.0	
	M a a l a e - K W P	m_wnd	59.8	59.5	59.8		59.7	K P a u n a h e - e	59.7	59.6	59.1
m_clm		59.8	59.8	59.9	59.7	59.8	59.8		59.7	59.6	
dm_wnd_sun		59.8	60.0	57.6	59.4	59.7	59.6		59.6	59.6	
dm_wnd_cld		59.7	59.8	59.8	59.6	59.6	59.7		59.5	59.5	
dm_clm_sun		59.9	60.0	58.1	57.3	59.8	59.7		59.5	59.5	
dm_clm_cld		59.6	59.7	59.5	59.5	59.7	59.8		59.7	59.7	
dp_wnd_sun		59.9	60.0	59.3	58.9	59.8	59.7		59.5	59.5	
dp_wnd_cld		59.8	60.0	60.0	59.8	59.8	59.8		59.8	59.8	
dp_clm_sun		59.1	59.3	59.2	58.5	59.7	59.8		59.6	59.6	
dp_clm_cld		59.5	59.5	59.5	59.5	59.7	59.7		59.6	59.4	
p_wnd		59.9	60.0	59.8	60.0	59.8	59.8		59.7	59.8	
p_clm		59.7	59.8	59.6	59.8	59.7	59.7		59.4	59.3	
M a W a a l i e n - a u		m_wnd	59.9	59.6	59.9	59.8	L L a a h h a a i l n u - a		59.5	59.5	59.0
	m_clm	59.8	59.8	59.9	59.7	59.8		59.8	59.7	59.7	
	dm_wnd_sun	59.9	60.0	59.6	59.6	59.5		59.7	59.6	59.6	
	dm_wnd_cld	59.8	59.9	59.8	59.6	59.5		59.6	59.4	59.5	
	dm_clm_sun	59.9	60.0	58.1	57.3	59.8		59.8	59.5	59.6	
	dm_clm_cld	59.6	59.7	59.5	59.5	59.7		59.8	59.8	59.8	
	dp_wnd_sun	59.9	60.0	59.3	58.9	59.7		59.6	59.4	59.5	
	dp_wnd_cld	59.8	59.9	60.0	59.8	59.8		59.8	59.8	59.8	
	dp_clm_sun	58.9	59.3	59.2	58.5	59.7		59.8	59.7	59.7	
	dp_clm_cld	59.5	59.5	59.5	59.5	59.7		59.7	59.7	59.7	
	p_wnd	59.8	60.0	59.8	60.0	59.8		59.8	59.8	59.8	
	p_clm	59.7	59.8	59.6	59.8	59.7		59.7	59.6	59.6	

When all three mitigation measures were enacted together (pilot protection, additional UFLS, and extended ride-through for PV) all simulations resulted in a stable system response. It should be noted that even though the simulations did not collapse, several 2016 and 2019 cases needed all three stages of load shedding for these line fault simulations. This low system frequency puts the system at risk of collapse should a subsequent outage occur.

- We recommend that MECO limit the amount of PV that connects to the system with the current Rule 14H under-voltage and over-frequency trip settings.

- We recommend that MECO add high-speed communication aided tripping to the 69 kV system to mitigate some of the inadvertent tripping of the PV already connected to the MECO system.
- MECO should review the UFLS scheme as the prevalence of the PV on the system may make the original design criteria of the UFLS scheme obsolete.
- We recommend that new settings for Rule 14H be revised to require ride-through requirements for the DG as opposed to trip requirements. We also recommend MECO evaluate the individual feeder penetration levels that are prudent with the revised Rule 14H settings.

9 Critical Clearing Times

The transient stability analysis found several contingencies that resulted in system instabilities. The first condition that caused system instability was the loss of a large amount of PV generation due to tripping from under-voltage or over-frequency trip settings. The second condition that caused a system instability was the loss of synchronism of either the Waena units or the 2.5 MW diesel units at Maalaea. In order to determine the maximum clearing times before either of these conditions occur, a series of simulations was run with fault clearing times ranging from 22 cycles to 4 cycles.

Table 9-1: Critical Clearing Times

Name Shorthand	Near Clearing	Far Clearing	Name Shorthand	Near Clearing	Far Clearing
0	9 cycles	22 cycles	10	9 cycles	12 cycles
1	9 cycles	21 cycles	11	9 cycles	11 cycles
2	9 cycles	20 cycles	12	9 cycles	10 cycles
3	9 cycles	19 cycles	13	9 cycles	9 cycles
4	9 cycles	18 cycles	14	8 cycles	8 cycles
5	9 cycles	17 cycles	15	7 cycles	7 cycles
6	9 cycles	16 cycles	16	6 cycles	6 cycles
7	9 cycles	15 cycles	17	5 cycles	5 cycles
8	9 cycles	14 cycles	18	4 cycles	4 cycles
9	9 cycles	13 cycles			

The 'Name Shorthand' column was used as part of the file naming to describe the fault clearing times for the different sensitivity cases. Each of the line faults that resulted in a loss of synchronism of either the small Maalaea units or the Waena units was re-run with the clearing times listed in Table 9-1. The same analysis was performed to determine the critical clearing time required to prevent the loss of PV with Rule 14H trip settings.

9.1 PV Tripping Prevention Analysis

Analysis was performed to determine the critical clearing time in order to prevent the loss of PV generation. This analysis was performed using the 2016_dp_clm_sun, 2019_dm_clm_sun, 2019_dm_wnd_sun, 2019_dp_clm_cld, 2019_dp_clm_sun, and 2019_dp_wnd_sun dispatch cases and the fault clearing times referenced above in Table 9-1 starting at 9 cycle clearing at both near and far ends. These cases were selected because the line fault simulations resulted in system collapse from the loss of PV generation.

Table 9-2: Critical Clearing Time for PV Tripping Prevention Table 1 of 2

Clearing Time	2016_dp_clm_sun					
	Maa-Lahaluna	Maa-KWP	Maa-Waiinu	Maa-Kihe	Maa-Puunene	Lahaina-Lahaluna
9 cycles	PV Trip	PV Trip	PV Trip	PV Trip	PV Trip	PV Trip
8 cycles	PV Trip	PV Trip	PV Trip	PV Trip	PV Trip	PV Trip
7 cycles	PV Trip	PV Trip	PV Trip	PV Trip	PV Trip	PV Trip
6 cycles	PV Trip	PV Trip	PV Trip	PV Trip	PV Trip	PV Trip
5 cycles	No Trip	No Trip	No Trip	No Trip	No Trip	No Trip

Clearing Time	2019_dm_clm_sun					
	Maa-Lahaluna	Maa-KWP	Maa-Waiinu	Maa-Kihe	Maa-Puunene	Lahaina-Lahaluna
9 cycles	PV Trip	PV Trip	PV Trip	PV Trip	PV Trip	PV Trip
8 cycles	No Trip	No Trip	No Trip	No Trip	No Trip	No Trip

Clearing Time	2019_dm_wnd_sun					
	Maa-Lahaluna	Maa-KWP	Maa-Waiinu	Maa-Kihe	Maa-Puunene	Lahaina-Lahaluna
9 cycles	No Trip	No Trip	No Trip	No Trip	No Trip	No Trip

Clearing Time	2019_dp_clm_sun					
	Maa-Lahaluna	Maa-KWP	Maa-Waiinu	Maa-Kihe	Maa-Puunene	Lahaina-Lahaluna
9 cycles	PV Trip	PV Trip	PV Trip	PV Trip	PV Trip	PV Trip
8 cycles	PV Trip	PV Trip	PV Trip	PV Trip	PV Trip	PV Trip
7 cycles	PV Trip	PV Trip	PV Trip	PV Trip	PV Trip	PV Trip
6 cycles	PV Trip	PV Trip	PV Trip	PV Trip	PV Trip	PV Trip
5 cycles	PV Trip	PV Trip	PV Trip	PV Trip	PV Trip	PV Trip
4 cycles	No Trip	No Trip	No Trip	No Trip	No Trip	No Trip

Table 9-2 shows the results of the PV tripping prevention analysis for four of the dispatch cases. The cells with text in red represent clearing times that would result in the loss of PV due to under-voltage or over-frequency tripping. The green highlighted cells would not result in the loss of PV generation. The 2019_dp_clm_sun case would trip the PV for all clearing times greater than 4 cycles. In the 2019 year, this will cause system collapse due to the loss of approximately 108 MW of generation. The 2019 alternate transmission configuration has minimal impact on the critical clearing time for PV tripping prevention. The alternate transmission configuration had a 1 cycle shorter critical clearing time for the 2019_dm_clm_sun case. All other dispatch cases had the same critical clearing time for the two transmission configurations.

Table 9-3: Critical Clearing Time for PV Tripping Prevention Table 2 of 2

Clearing Time	2019_dp_clm_cld					
	Maa-Lahaluna	Maa-KWP	Maa-Waiinu	Maa-Kihe	Maa-Puunene	Lahaina-Lahaluna
9 cycles	PV Trip	PV Trip	PV Trip	PV Trip	PV Trip	PV Trip
8 cycles	PV Trip	PV Trip	PV Trip	PV Trip	PV Trip	PV Trip
7 cycles	PV Trip	PV Trip	PV Trip	PV Trip	PV Trip	PV Trip
6 cycles	PV Trip	PV Trip	PV Trip	PV Trip	PV Trip	PV Trip
5 cycles	PV Trip	PV Trip	PV Trip	PV Trip	PV Trip	PV Trip
4 cycles	PV Trip	PV Trip	PV Trip	PV Trip	PV Trip	PV Trip

Clearing Time	2019_dp_wnd_sun					
	Maa-Lahaluna	Maa-KWP	Maa-Waiinu	Maa-Kihe	Maa-Puunene	Lahaina-Lahaluna
9 cycles	PV Trip	PV Trip	PV Trip	PV Trip	PV Trip	PV Trip
8 cycles	PV Trip	PV Trip	PV Trip	PV Trip	PV Trip	PV Trip
7 cycles	PV Trip	PV Trip	PV Trip	PV Trip	PV Trip	PV Trip
6 cycles	PV Trip	PV Trip	PV Trip	PV Trip	PV Trip	PV Trip
5 cycles	PV Trip	PV Trip	PV Trip	PV Trip	PV Trip	PV Trip
4 cycles	PV Trip	PV Trip	PV Trip	PV Trip	PV Trip	PV Trip

Table 9-3 shows that even with 4 cycle clearing on both ends of a 69 kV transmission line, the acceleration at the Maalaea plant is fast enough that the system frequency will exceed 60.5 Hz for a fault located at the Maalaea substation for the 2019_dp_clm_cld and 2019_dp_wnd_sun cases.

The PV tripping prevention cases highlight an important issue. Even with fast clearing, a fault located at the Maalaea generation plant could result in the loss of all PV that has the Rule 14H trip settings. The trip settings should be revised as soon as possible, and, if possible, the existing distributed generation should be updated to provide improved ride-through characteristics.

9.2 Loss of Synchronism Analysis

Some line faults caused a loss of synchronism of the small Maalaea units and the Waena units for the 2016_p_clm, 2019_dp_clm_cld, 2019_p_wnd, and 2019_p_clm dispatch cases. The following tables show the results of the analysis for these cases.

Table 9-6: Critical Clearing Time for 2019_dp_clm_cld Dispatch Case Alt. Transmission

Clearing Times	2019_dp_clm_cld						
	Maa-Lahaluna	Maa-KWP	Maa-Waiinu	Maa-Kihei	Maa-Puunene	Lahaina-Lahaluna	Kanaha-Puunene
9, 22 cycles	Stable	Stable	Stable	Stable	Stable	Stable	Unstable
9, 21 cycles	Stable	Stable	Stable	Stable	Stable	Stable	Unstable
9, 20 cycles	Stable	Stable	Stable	Stable	Stable	Stable	Unstable
9, 19 cycles	Stable	Stable	Stable	Stable	Stable	Stable	Unstable
9, 18 cycles	Stable	Stable	Stable	Stable	Stable	Stable	Unstable
9, 17 cycles	Stable	Stable	Stable	Stable	Stable	Stable	Unstable
9, 16 cycles	Stable	Stable	Stable	Stable	Stable	Stable	Unstable
9, 15 cycles	Stable	Stable	Stable	Stable	Stable	Stable	Unstable
9, 14 cycles	Stable	Stable	Stable	Stable	Stable	Stable	Stable

Table 9-5 shows the critical clearing time results for the 2019_dp_clm_cld dispatch case while Table 9-6 shows the results for the alternate transmission configuration. The cells highlighted in red represent the contingency and clearing times in which the Waena units lose synchronism with the rest of the grid. For faults near the Waena plant, the Waena units lose synchronism with the rest of the grid. As long as the fault is cleared faster than 14 cycles, the units remain in synchronism. The Kanaha-Waena and Pukalani-Waena outages were not simulated with the alternate transmission configuration. The alternate transmission configuration is expected to perform worse than the preferred option since the Kanaha-Puunene line causes a loss of synchronism with the alternate configuration, but did not for the preferred option.

Table 9-7: Critical Clearing Time for 2019_p_clm Dispatch Case

Clearing Times	2019_p_clm								
	Maa-Lahaluna	Maa-KWP	Maa-Waiinu	Maa-Kihei	Maa-Puunene	Lahaina-Lahaluna	Kanaha-Puunene	Pukalani-Waena	Kanaha-Waena
9, 22 cycles	Unstable	Unstable	Unstable	Unstable	Unstable	Unstable	Stable	Unstable	Unstable
9, 21 cycles	Unstable	Unstable	Unstable	Unstable	Unstable	Unstable	Stable	Unstable	Unstable
9, 20 cycles	Unstable	Unstable	Unstable	Unstable	Unstable	Unstable	Stable	Unstable	Unstable
9, 19 cycles	Unstable	Unstable	Unstable	Unstable	Unstable	Unstable	Stable	Unstable	Unstable
9, 18 cycles	Unstable	Unstable	Unstable	Unstable	Unstable	Unstable	Stable	Unstable	Unstable
9, 17 cycles	Unstable	Unstable	Unstable	Unstable	Unstable	Unstable	Stable	Unstable	Unstable
9, 16 cycles	Unstable	Unstable	Unstable	Unstable	Unstable	Unstable	Stable	Unstable	Unstable
9, 15 cycles	Unstable	Unstable	Unstable	Unstable	Unstable	Unstable	Stable	Unstable	Unstable
9, 14 cycles	Stable	Stable	Stable	Stable	Stable	Stable	Stable	Stable	Unstable
9, 13 cycles	Stable	Stable	Stable	Stable	Stable	Stable	Stable	Stable	Unstable
9, 12 cycles	Stable	Stable	Stable	Stable	Stable	Stable	Stable	Stable	Stable

Table 9-7 shows the critical clearing time results for the 2019_p_clm dispatch case with the alternate transmission configuration. The cells highlighted in orange represent the contingency and clearing times that resulted in the small Maalaea units losing synchronism with the rest of the grid. The red highlighted cells were cases in which the Waena units lost synchronism.

For clearing times of 9 cycles at the near end and 14 cycles at the far end or faster, all units remain in synchronism. Figure 9-1 below shows the angle of the M1 unit relative to the M14 unit for clearing times of 9 cycles near, 19 cycles far to 9 cycles near, 14 cycles far.

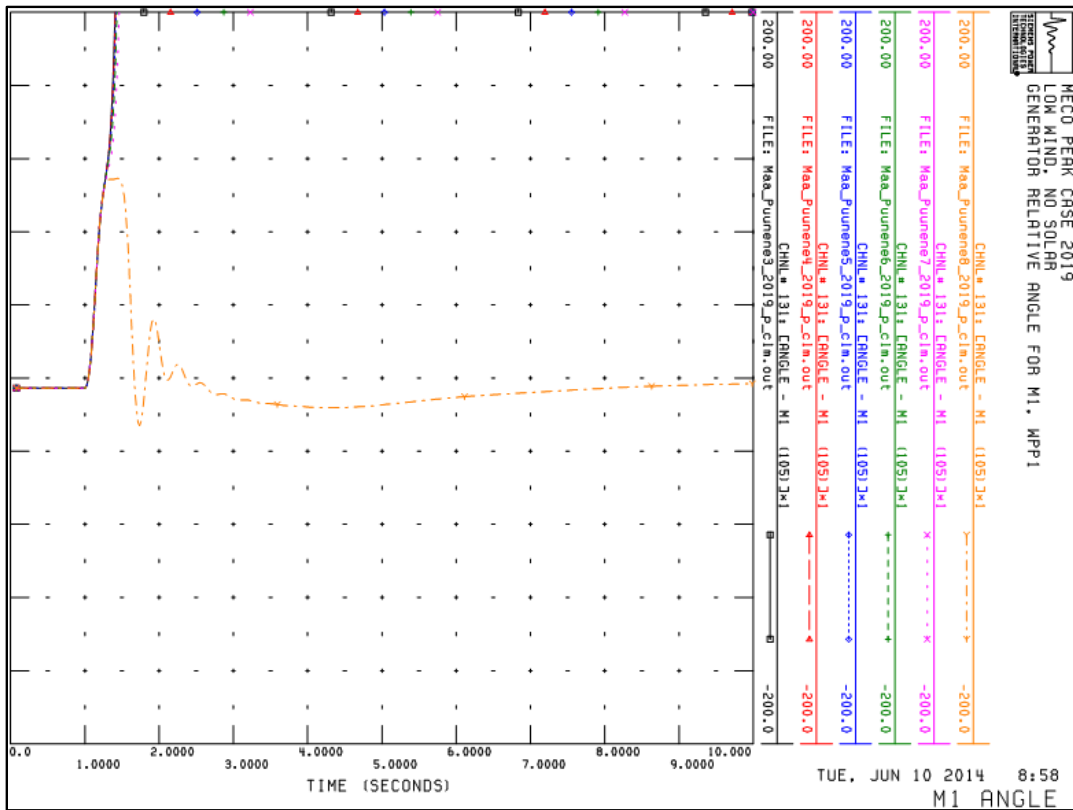

Figure 9-1: Maalaea 1 Rotor Angle for Various Clearing Times

Figure 9-1 shows the rotor angle for the Maalaea 1 unit for clearing times of 9 cycles near, 19 cycles far to 9 cycles near, 14 cycles far for a fault of the Kanaha – Puunene line. The orange trace shows that the unit does not lose synchronism with the rest of the grid for clearing time 8 (9 cycles near, 14 cycles far). Figure 9-2 shows the same information for the Pukalani-Waena outage showing the Waena unit 1 angle.

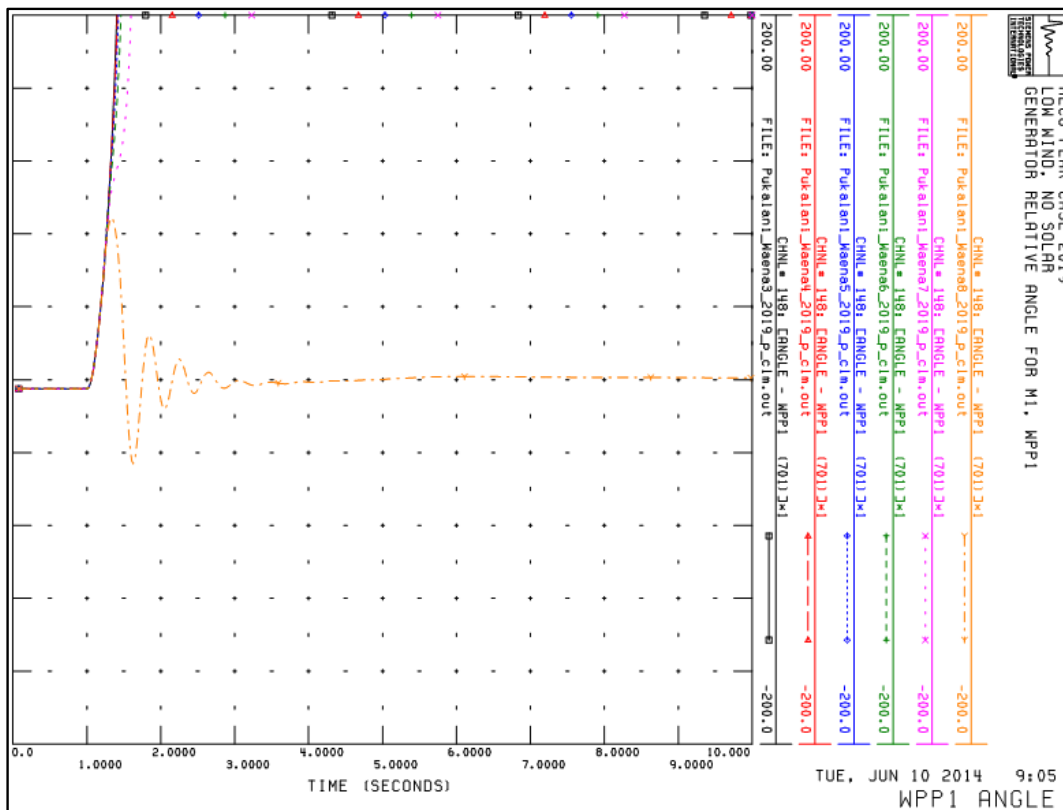

Figure 9-2: Waena 1 Rotor Angle for Various Clearing Times

Figure 9-2 shows the rotor angle for the Waena 1 unit for clearing times of 9 cycles near, 19 cycles far to 9 cycles near, 14 cycles far for a fault of the Pukalani-Waena line. The orange trace shows that the unit does not lose synchronism with the rest of the grid for clearing time of 9 cycles near and 14 cycles far.

Table 9-8: Critical Clearing Time for 2019_p_clm Dispatch Case Alternate Configuration

Clearing Times	2019_p_clm						
	Maa-Lahaluna	Maa-KWP	Maa-Waiinu	Maa-Kihei	Maa-Puunene	Lahaina-Lahaluna	Kanaha-Puunene
9, 22 cycles	Unstable	Unstable	Unstable	Unstable	Unstable	Unstable	Unstable
9, 21 cycles	Unstable	Unstable	Unstable	Unstable	Unstable	Unstable	Unstable
9, 20 cycles	Unstable	Unstable	Unstable	Unstable	Unstable	Unstable	Unstable
9, 19 cycles	Unstable	Unstable	Unstable	Unstable	Unstable	Unstable	Unstable
9, 18 cycles	Unstable	Unstable	Unstable	Unstable	Unstable	Unstable	Unstable
9, 17 cycles	Unstable	Unstable	Unstable	Unstable	Unstable	Unstable	Unstable
9, 16 cycles	Unstable	Unstable	Unstable	Unstable	Unstable	Unstable	Unstable
9, 15 cycles	Unstable	Unstable	Unstable	Unstable	Unstable	Unstable	Unstable
9, 14 cycles	Stable	Stable	Stable	Stable	Stable	Stable	Stable

Table 9-8 shows the critical clearing time results for the 2019_p_clm dispatch case with the alternate transmission configuration. The cells highlighted in orange represent the contingency and clearing times that resulted in the small Maalaea units losing synchronism with the rest of the grid. The purple highlighted cells were cases in which both Maalaea and Waena units lost synchronism.

Table 9-9: Critical Clearing Time for 2019_p_wnd Dispatch Case

Clearing Times	2019_p_wnd								
	Maa-Lahaluna	Maa-KWP	Maa-Waiinu	Maa-Kihei	Maa-Puunene	Lahaina-Lahaluna	Kanaha-Puunene	Pukalani-Waena	Kanaha-Waena
9, 22 cycles	Stable	Stable	Stable	Stable	Stable	Stable	Unstable	Unstable	Unstable
9, 21 cycles	Stable	Stable	Stable	Stable	Stable	Stable	Unstable	Unstable	Unstable
9, 20 cycles	Stable	Stable	Stable	Stable	Stable	Stable	Unstable	Unstable	Unstable
9, 19 cycles	Stable	Stable	Stable	Stable	Stable	Stable	Unstable	Unstable	Unstable
9, 18 cycles	Stable	Stable	Stable	Stable	Stable	Stable	Stable	Unstable	Unstable
9, 17 cycles	Stable	Stable	Stable	Stable	Stable	Stable	Stable	Unstable	Unstable
9, 16 cycles	Stable	Stable	Stable	Stable	Stable	Stable	Stable	Unstable	Unstable
9, 15 cycles	Stable	Stable	Stable	Stable	Stable	Stable	Stable	Unstable	Unstable
9, 14 cycles	Stable	Stable	Stable	Stable	Stable	Stable	Stable	Stable	Unstable
9, 13 cycles	Stable	Stable	Stable	Stable	Stable	Stable	Stable	Stable	Unstable
9, 12 cycles	Stable	Stable	Stable	Stable	Stable	Stable	Stable	Stable	Stable

Table 9-9 shows the critical clearing time results for the 2019_p_wnd dispatch case. The cells highlighted in red represent the contingency and clearing times that resulted in the Waena units losing synchronism. For clearing times of 9 cycles at the near end and 12 cycles at the far end or faster, all units remain in synchronism.

When any fault is cleared faster than 9 cycles at the near end and 12 cycles at the far end, all units remain in synchronism. These units are losing synchronism with the rest of the MECO system because they are accelerating at different rates during the fault. While the loss of the 2.5 MW diesels would likely not cause a cascading system collapse, the loss of the Waena plant could. MECO should take steps to clear faults near the Waena plant to prevent the loss of synchronism of those units.

Table 9-10: Critical Clearing Time for 2019_p_wnd Dispatch Case Alternate Configuration

Clearing Times	2019_p_wnd						
	Maa-Lahaluna	Maa-KWP	Maa-Waiinu	Maa-Kihei	Maa-Puunene	Lahaina-Lahaluna	Kanaha-Puunene
9, 22 cycles	Stable	Stable	Stable	Stable	Stable	Stable	Unstable
9, 21 cycles	Stable	Stable	Stable	Stable	Stable	Stable	Unstable
9, 20 cycles	Stable	Stable	Stable	Stable	Stable	Stable	Unstable
9, 19 cycles	Stable	Stable	Stable	Stable	Stable	Stable	Unstable
9, 18 cycles	Stable	Stable	Stable	Stable	Stable	Stable	Unstable
9, 17 cycles	Stable	Stable	Stable	Stable	Stable	Stable	Unstable
9, 16 cycles	Stable	Stable	Stable	Stable	Stable	Stable	Unstable
9, 15 cycles	Stable	Stable	Stable	Stable	Stable	Stable	Unstable
9, 14 cycles	Stable	Stable	Stable	Stable	Stable	Stable	Unstable
9, 13 cycles	Stable	Stable	Stable	Stable	Stable	Stable	Stable

The alternate configuration has a critical clearing time of 9 cycles on the near end and 14 cycles on the far end for the Kanaha-Puunene outage. The preferred transmission configuration has a critical clearing time that is 5 cycles longer than the alternate configuration.

Since the acceleration of a unit during the fault is closely related to the inertia of the unit, we investigated the impact that increasing the inertia constant of the Waena units would have on the loss of synchronism at that plant. The original inertia constant used for the proposed Waena units was 1.445. We ran a sensitivity case with the inertia constant increased by 38% to 2.0.

The following table shows the critical clearing time for the fault of the Kanaha –Waena line fault with and without additional inertia.

Table 9-11: Critical Clearing Time for Waena Synchronism – Inertia Sensitivity

Clearing Times	2019_dp_clm_cld		2019_p_clm		2019_p_wnd	
	Normal	Extra Inertia	Normal	Extra Inertia	Normal	Extra Inertia
9, 22 cycles	Unstable	Unstable	Unstable	Unstable	Unstable	Unstable
9, 21 cycles	Unstable	Unstable	Unstable	Unstable	Unstable	Unstable
9, 20 cycles	Unstable	Unstable	Unstable	Unstable	Unstable	Unstable
9, 19 cycles	Unstable	Unstable	Unstable	Unstable	Unstable	Unstable
9, 18 cycles	Unstable	Unstable	Unstable	Unstable	Unstable	Unstable
9, 17 cycles	Unstable	Unstable	Unstable	Unstable	Unstable	Unstable
9, 16 cycles	Unstable	Stable	Unstable	Stable	Unstable	Unstable
9, 15 cycles	Unstable	Stable	Unstable	Stable	Unstable	Stable
9, 14 cycles	Unstable	Stable	Unstable	Stable	Unstable	Stable
9, 13 cycles	Stable	Stable	Unstable	Stable	Unstable	Stable
9, 12 cycles	Stable	Stable	Stable	Stable	Stable	Stable

Table 9-11 shows the impact that the additional inertia on the Waena units has on the critical clearing time. As discussed earlier, the critical clearing time for the Kanaha – Puunene fault would be 9 cycles at the near end and 12 cycles at the far end. However, when the Waena unit inertia was increased, the critical clearing time increased to 9 cycles at the near end and 15 cycles at the far end.

We recommend that the units selected for the Waena Power Plant be specified with inertia and response characteristics to mitigate the risk of collapse and out-of-step conditions on the MECO system. The additional inertia will allow the units at Waena to remain in synchronism with the rest of the MECO system for longer clearing times. The additional inertial will have an additional benefit of reducing the rate of frequency decay due to the loss of generation, allowing more time for the MECO system to respond to events.

10 Short Circuit Current Impacts

The minimum short circuit current for the lowest generation scenarios were analyzed to evaluate the impact that reduced short circuit current might have on the wind turbine generation and battery inverters. The minimum and daytime minimum load dispatches were used for the minimum generation configurations. According to GE documentation for their 1.6 MW wind turbines the generators are “designed to operate with a composite short circuit ratio of no lower than 2.78 at the high side of the turbine transformer.” The composite short circuit ratio is defined as the ratio of the composite short circuit MVA (with the high side of all the turbine transformers bused together and a 3-phase short circuit applied at that point) to the nameplate MW of the wind farm.

Using the PSS/E program, 3-phase faults were applied at the 34.5 kV side of each of the step-up transformers at each wind farm, and the fault current contribution from the MECO system was recorded. We compiled the results and calculated the composite short circuit ratio. The results are shown below in Table 10-1.

Table 10-1: Composite Short Circuit Results

	Dispatch	KWP1 30 MVA Plant				KWP2 21 MVA Plant				AWF 21 MVA Plant			
		Fault Calculation				Fault Calculation				Fault Calculation			
		Amps	kV	MVA	SCR	Amps	kV	MVA	SCR	Amps	kV	MVA	SCR
2014	m_wnd	3693.7	34.5	220.72	7.36	1960.9	34.5	117.18	5.58	1362.8	34.5	81.44	3.88
	m_clm	4232.5	34.5	252.92	8.43	2379.9	34.5	142.21	6.77	1413.9	34.5	84.49	4.02
	dm_wnd_sun	3698.9	34.5	221.03	7.37	2234.3	34.5	133.51	6.36	1362.4	34.5	81.41	3.88
	dm_clm_sun	4218.7	34.5	252.09	8.40	2379.0	34.5	142.16	6.77	1414.9	34.5	84.55	4.03
2016	m_wnd	3810.2	34.5	227.68	7.59	2205.1	34.5	131.77	6.27	1363.2	34.5	81.46	3.88
	m_clm	4219.6	34.5	252.15	8.40	2378.0	34.5	142.10	6.77	1462.7	34.5	87.40	4.16
	dm_wnd_sun	3622.1	34.5	216.44	7.21	2195.7	34.5	131.21	6.25	1352.4	34.5	80.81	3.85
	dm_clm_sun	4210.5	34.5	251.60	8.39	2370.3	34.5	141.64	6.74	1411.0	34.5	84.32	4.02
2019	m_wnd	3094.5	34.5	184.91	6.16	1944.0	34.5	116.17	5.53	1282.0	34.5	76.61	3.65
	m_clm	4001.8	34.5	239.13	7.97	2316.0	34.5	138.39	6.59	1411.3	34.5	84.33	4.02
	dm_wnd_sun	2761.5	34.5	165.02	5.50	1904.3	34.5	113.79	5.42	1249.0	34.5	74.63	3.55
	dm_clm_sun	2915.1	34.5	174.19	5.81	1961.3	34.5	117.20	5.58	1253.7	34.5	74.92	3.57
2019	m_wnd	3789.7	34.5	226.46	7.55	1942.6	34.5	116.08	5.53	1245.6	34.5	74.43	3.54
	m_clm	3999.8	34.5	239.01	7.97	2315.4	34.5	138.36	6.59	1379.5	34.5	82.43	3.93
	dm_wnd_sun	2762.5	34.5	165.08	5.50	1904.7	34.5	113.82	5.42	1225.4	34.5	73.22	3.49
	dm_clm_sun	2914.1	34.5	174.13	5.80	1960.9	34.5	117.18	5.58	1230.5	34.5	73.53	3.50

The “Fault Calculation” columns list the fault current (Amps), bus voltage (kV), and fault MVA. The SCR is calculated as the (Fault MVA) / (MVA Plant). All of the generation dispatch cases have fault current levels that will allow operation of the wind farms. It should be noted that as the number of must-run units decreased between 2016 and 2019, the short circuit ratio at the KWP1 and KWP2 plants also decreased, but remained above the minimum SCR. However, the fault currents at the AWF plant remained largely unchanged. The impact that the transmission upgrades have on the 69 kV system basically offsets the impact of having fewer units online. All generation configurations provided enough short circuit current for the wind farms to operate reliably.

These calculations were repeated for the N-1 conditions for the outage of each 69 kV line leaving each of the wind farm substations. The results are shown below in Table 10-2.

Table 10-2: N-1 Available Fault Current and SCR 1 of 2

	Dispatch	Maalaea Line Out				Maalaea Line Out				Wailea Line Out			
		KWP1	30	MVA Plant	SCR	KWP2	21	MVA Plant	SCR	AWF	21	MVA Plant	SCR
		Amps	kV	MVA	SCR	Amps	kV	MVA	SCR	Amps	kV	MVA	SCR
2014	m_wnd	2411.0	34.5	144.1	4.80	1711.4	34.5	102.3	4.87	1217.5	34.5	72.8	3.46
	m_clm	2613.9	34.5	156.2	5.21	1781.4	34.5	106.4	5.07	1255.0	34.5	75.0	3.57
	dm_wnd_sun	2409.5	34.5	144.0	4.80	1702.4	34.5	101.7	4.84	1215.4	34.5	72.6	3.46
	dm_clm_sun	2612.8	34.5	156.1	5.20	1788.3	34.5	106.9	5.09	1262.2	34.5	75.4	3.59
2019	m_wnd	2148.6	34.5	128.4	4.28	1545.1	34.5	92.3	4.40	1126.4	34.5	67.3	3.21
	m_clm	2516.8	34.5	150.4	5.01	1746.1	34.5	104.3	4.97	1218.9	34.5	72.8	3.47
	dm_wnd_sun	1971.7	34.5	117.8	3.93	1510.8	34.5	90.3	4.30	1098.6	34.5	65.6	3.13
	dm_clm_sun	2051.8	34.5	122.6	4.09	1548.8	34.5	92.5	4.41	1102.2	34.5	65.9	3.14
2019	m_wnd	2147.1	34.5	128.3	4.28	1544.3	34.5	92.3	4.39	1131.1	34.5	67.6	3.22
	m_clm	2516.1	34.5	150.4	5.01	1745.8	34.5	104.3	4.97	1223.0	34.5	73.1	3.48
	dm_wnd_sun	1972.2	34.5	117.9	3.93	1511.0	34.5	90.3	4.30	1101.8	34.5	65.8	3.14
	dm_clm_sun	2051.2	34.5	122.6	4.09	1548.5	34.5	92.5	4.41	1105.3	34.5	66.0	3.15

Table 10-3: N-1 Available Fault Current and SCR 2 of 2

	Dispatch	Lahaina Line Out				Lahaina Line Out				Kealahou Line Out			
		KWP1	30	MVA Plant		KWP2	21	MVA Plant		AWF	21	MVA Plant	
		Amps	kV	MVA	SCR	Amps	kV	MVA	SCR	Amps	kV	MVA	SCR
2014	m_wnd	3549.0	34.5	212.1	7.07	2179.4	34.5	130.2	6.20	1266.8	34.5	75.7	3.60
	m_clm	4045.5	34.5	241.7	8.06	2323.4	34.5	138.8	6.61	1313.9	34.5	78.5	3.74
	dm_wnd_sun	3554.4	34.5	212.4	7.08	2181.1	34.5	130.3	6.21	1267.4	34.5	75.7	3.61
	dm_clm_sun	4034.3	34.5	241.1	8.04	2320.3	34.5	138.7	6.60	1311.9	34.5	78.4	3.73
2019	P m_wnd	2990.6	34.5	178.7	5.96	1934.5	34.5	115.6	5.50	1239.9	34.5	74.1	3.53
	R m_clm	3838.6	34.5	229.4	7.65	2261.7	34.5	135.1	6.44	1362.8	34.5	81.4	3.88
	E dm_wnd_sun	2687.0	34.5	160.6	5.35	1863.7	34.5	111.4	5.30	1209.3	34.5	72.3	3.44
	F dm_clm_sun	2828.2	34.5	169.0	5.63	1918.9	34.5	114.7	5.46	1214.7	34.5	72.6	3.46
9	A m_wnd	2987.4	34.5	178.5	5.95	1933.2	34.5	115.5	5.50	1170.1	34.5	69.9	3.33
	L m_clm	3836.8	34.5	229.3	7.64	2261.2	34.5	135.1	6.43	1290.9	34.5	77.1	3.67
	T dm_wnd_sun	2688.0	34.5	160.6	5.35	1864.0	34.5	111.4	5.30	1153.6	34.5	68.9	3.28
	. dm_clm_sun	2827.3	34.5	168.9	5.63	1918.6	34.5	114.6	5.46	1160.2	34.5	69.3	3.30

Table 10-2 and Table 10-3 show that even with a line out of service, the minimum short circuit at each of the wind plants is greater than 3.0. All of this analysis assumes that AWF has a similar short circuit ratio requirement similar to the requirements of the GE 1.5 MW wind turbines. If the AWF wind farm requires a SCR greater than 3.1, the minimum generation configuration in 2019 will not provide sufficient short circuit current for reliable operation of the AWF inverters. Both the preferred and alternate transmission configurations have sufficient fault current for the wind turbine inverters to function properly.

11 Protection Review

The MECO transmission system is operated at 69 kV and 23 kV. The 69 kV portion is generally operated in a looped configuration while the 23 kV system has loops in the vicinity of the Kahului Power plant. It is assumed that the majority of the transmission system is protected by impedance mho distance relays. Varying dispatch scenarios are expected to have little impact on the operation of these schemes given that distance relays are generally immune to differences in fault current source impedances. However, the fault detection settings would need to be examined as they are sensitive to expected fault current variation. Operating the 69 kV and 23 kV systems in their present looped configurations would make step-distance protection schemes viable. If operating the lines with broken loops is expected then communication-aided protection schemes would need to be considered.

The details of the distribution system protection are not known at this time. However, it is assumed to be a classical application of substation relays, line fuses, and line reclosers. A collection of substations considered typical of the MECO system were analyzed for fault current variation at the distribution feeder bus. Fault studies were run to find the variation in minimum available fault current between the existing minimum dispatch scenario and the proposed future minimum dispatch scenarios. The fault analysis was performed for the 2014, 2016, and 2019 cases. The transmission upgrades increase the available fault current, and largely offset the reduced number of units in the future cases. The change between the minimum fault current seen in 2014 and the minimum fault current seen in 2019 was found to be approximately 10%, which will have minimal impact on the operation of the distribution protection.

12 Conclusions and Recommendations

MECO is planning to make significant changes to their system in order to respond to variable generation and decrease the amount of curtailed renewable energy. MECO is planning on retiring the Kahului Power Plant, and installing fast-ramping, quick startup units at the Waena Power Plant. In addition to the generation updates, MECO will be making several transmission system upgrades to compensate for the KPP retirement's effect on the 23 kV voltage support. Overall, these system changes will improve the system's ability to accept more renewable energy.

Primarily due to the projected growth of distributed generation, several system limitations were identified in this study.

- Ramp Rate Adequacy
 - With 128 MW of PV capacity and 72 MW of wind capacity, the MECO generation would need to have a system-wide ramp rate capability of at least 5.5 MW/minute to maintain system frequency. The minimum unit configuration would only be able to provide a ramp rate capability of approximately 5 MW/minute. Additional ramping resources will be required which could be in the form of additional online units, energy storage, demand response, or additional usage of the existing battery systems or use of curtailed wind energy for regulation.
- Steady State Power Flow Results
 - No single 69 kV outage causes any line to exceed its emergency current rating.
 - The Waiinu 69 kV bus was outside its voltage limits due to the loss of the Maalaea – Waiinu line. Should MECO either have the capability to control the taps on the 69/23 kV Waiinu transformer, or have reverse power controls on the transformer, the taps can be configured such that the Waiinu 69 kV bus is kept within its voltage limit.
 - Low voltages can occur at the Kihei 69 kV bus at peak load with AWF out of service. Voltage support is required at the Kihei substation with the alternate 2019 transmission configuration.
 - The Pukalani 23 kV feeder will require additional voltage control resources to properly maintain the voltage along the entire circuit length.
 - In order to maintain the MECO generator power factors near 0.95, all MECO capacitor banks were switched in for the 2019 peak case. EPS recommends additional voltage support resources are added to the system for peak loading conditions.
- Transient Stability Results
 - With the large amount of projected PV growth on the island, the tripping of the PV becomes the dominant contingency for MECO, and can lead to system collapse.
 - Upgrading transmission protection to use high-speed communications aided tripping on all 69 kV transmission lines, increasing the number of circuits on UFLS, and forcing new PV to use extended ride-through settings were all evaluated as system improvements to prevent system collapse.
 - Individually, none of the three system improvements could prevent system collapse, but when all three system improvements are taken together, the system will survive for each contingency studied for each dispatch case.

- EPS recommends a detailed UFLS study be conducted that looks at the impact of a loss of the distributed PV generation, and also looks at the effective decrease in load in each stage of the UFLS design due to distributed PV on each substation feeder.
- The availability of battery frequency support has a significant impact on the number of stages of load shed needed to arrest system frequency decay. Without battery support, the loss of a single conventional generation unit coupled with the loss of legacy PV can cause system collapse. With battery support the system remains stable.
- Short Circuit Current Impacts
 - The future minimum generation configurations laid out in the curtailment reduction plan will have fewer units online than the current system will allow. With fewer units online, the available fault currents will decrease.
 - The available fault current for the minimum generation configuration in year 2019 is sufficient for wind farm operation at KWP.
 - The available fault current for the minimum generation configuration in year 2019 is sufficient for wind farm operation at Auwahi.
- Critical Clearing Time
 - The critical clearing time to avoid the tripping of PV and the critical clearing time to avoid the loss of synchronism of the Waena plant was studied.
 - Even with 4 cycle clearing for a 69 kV fault, the system frequency exceeds the 60.5 Hz trip setting of the PV, and can cause system collapse.
 - Faults near the Waena plant line can cause the Waena unit to lose synchronism with the Maalaea units. The loss of these units would severely impact the system and potentially lead to system collapse. Synchronism could be maintained if the fault were cleared in 9 cycles at the near end and 12 cycles at the far end.
 - We recommend that MECO evaluate the inertia and response characteristics when selecting the Waena Power Plant units.
- Rule 14H Modifications
 - We recommend MECO revise Rule 14H to provide ride-thru requirements for all DG installed under Rule 14H
 - The requirement for DG to ride-thru many of the system events will result in increased voltage and frequency ride-thru requirements for PV in particular. The increased requirements for the system protection will result in increased risk to the distribution feeders following isolation from the power system. MECO should evaluate the maximum allowable penetration levels for distribution feeders with the new system ride-thru requirements.



**Hawaii Electric Light Company, Inc.
High Photovoltaic Penetration Study
April 20, 2014**

John DL Hieb
Michael J. Bradley P.E.
James W. Cote Jr., Ph.D., P.E.

Summary of Changes

Revision	Revision Date	Revision Description
0	November 27, 2013	Preliminary Report First Draft
1	March 7, 2014	Final Report
2	April 19, 2014	Final Revisions for Clarification
3	April 20, 2014	Added PV quantities

Table of Contents

1 EXECUTIVE SUMMARY 1

2 INTRODUCTION..... 4

3 ASSUMPTIONS 5

3.1 Power Flow Load Model 5

3.2 Power Flow Photovoltaic Model 5

3.3 Dynamic Simulation Photovoltaic Generation Model 6

3.4 Power Flow Dispatch Cases 7

4 HELCO STEADY STATE ANALYSIS 8

4.1 Contingency Analysis..... 13

4.2 Breaker Angle Analysis..... 14

4.3 Steady State Distribution Voltage Analysis 17

4.4 Voltage Flicker Analysis..... 24

4.5 Steady State Conclusions and Recommendations 30

5 TRANSIENT STABILITY ANALYSIS 31

5.1 Unit Trip Simulation Results..... 31

5.2 Line Fault and Trip Results 33

5.3 Energy Storage Sensitivity Cases..... 40

5.4 Transient Stability Results and Conclusions 41

6 REGULATION AND RAMP RATE ANALYSIS..... 42

7 PROTECTION..... 48

7.1 Introduction 48

7.2 Assumptions 49

7.3 Distribution Circuit..... 51

7.4 Substation Transformers..... 64

7.5 Transmission..... 66

7.6 Protection Conclusions and Recommendations 76

Table of Figures

Figure 1: January Daily Load Profiles for 2008, 2012, and 2013..... 8
 Figure 2: Distribution Circuit Configuration for Voltage Profile Analysis..... 17
 Figure 3: Captain Cook 12 Voltage Profiles..... 19
 Figure 4: Captain Cook 12 Voltage Profiles With 0.95 Power Factor Leading 21
 Figure 5: Captain Cook 12 Voltage Profiles vs. DG Power Factor 22
 Figure 6: Voltage Change due to DG Cycling..... 23
 Figure 7: Voltage Flicker Irritation Limits 25
 Figure 8: Solar Ramp Counts for 1-year at Kawaiilani 26
 Figure 9: Cumulative PV Ramps for Kawaiilani 27
 Figure 10: Distribution Analysis One-Line 28
 Figure 11: Unit Speed Recordings, Normally Cleared Fault on Line 6400, Case 155d50..... 34
 Figure 12: Loss of Line 7500..... 35
 Figure 13: Unit Speed Recordings for 11-Cycle Fault on Line 7200, Case 145d50 37
 Figure 14: Unit Speed Recordings for 11-Cycle Fault on Line 7400, Case 145dmax 39
 Figure 15: Cumulative Ramp Rate Results 30 MVA PV Capacity 43
 Figure 16: 20-Minute Scatter Plot for March 16-31 with 30 MVA Solar Capacity 47
 Figure 17: Single line diagram of 12.47kV island model..... 59
 Figure 18: 1 MVA DG and Grounding Bank at Bus 0 60
 Figure 19: 3 MVA DG and Grounding Bank at Bus 0 60
 Figure 20: Grounding Ratios Versus DG Level 61

Table of Tables

Table 1: Minimum Unit Configurations as Defined in RSWG Study	7
Table 2: Scenario 'A' Dispatch Cases	9
Table 3: Scenario 'B' Dispatch Cases.....	10
Table 4: Scenario 'C' Dispatch Cases.....	11
Table 5: Scenario 'D' Dispatch Cases	12
Table 6: Maximum DG Dispatch Cases	13
Table 7: 7100 Line Outage Causing High Flows.....	14
Table 8: Breaker Angle Analysis Results 1 of 2.....	15
Table 9: Breaker Angle Analysis Results 2 of 2.....	16
Table 10: Load Distribution.....	17
Table 11: Load and DG Distribution Labels.....	18
Table 12: Circuits Flagged for Further Distribution Voltage Profile Analysis	20
Table 13: System VAR Requirements With Varied DG Power Factor.....	24
Table 14: DG Impacts on the Utility Based on DG Power Factor.....	24
Table 15: Kealia 11 Change in Voltage Due to Change in PV Output.....	29
Table 16: Voltage Flicker Maximum Allowable Capacity on Kealia 11	30
Table 17: Steady State Circuit Concerns	31
Table 18: Load Shed Results for Unit Trips	32
Table 19: UFLS Stages Shed Due to Delayed Fault Clearing.....	38
Table 20: BESS Sensitivity Case Results	40
Table 21: Ramp Rate Needs by Installed Solar Capacity	44
Table 22: HELCO Unit Ramp Rates	45
Table 23: Minimum Unit Configurations	45
Table 24: List of distribution circuits with possible overcurrent pickup issues	53
Table 25: Branch Fuse Requirement.....	54
Table 26: Sub-Branch Fuse Requirement.....	55
Table 27: HELCO 34.5kV, 5 MVA and Less Transformer Fuse Protection.....	66
Table 28: 69 kV Lines That Have Tapped Loads	68
Table 29: 34.5 kV Lines That Have Tapped Loads	69
Table 30: 69KV Transmission Relay Protection for Lines with Tapped Load	70
Table 31: 69KV Protective Relay Communication, Reclosing and Synch Check	71

1 Executive Summary

HELCO contracted with EPS to study their electrical system at different photovoltaic (PV) penetration levels on distribution circuits of 50%, 75%, 100%, and 125% of the circuit's minimum daytime load. The objectives were to determine the impacts that the PV penetration have on the HELCO system as a whole, the distribution circuits to which the PV is connected, and the system protection impacts. This analysis focused only on roof-top PV and its characteristics. Plant or large PV installations do not have the same characteristics as Rule 14H compliant PV and do not have the same system impact.

While all distributed generation impacts both the transmission and distribution levels of the utility, roof-top PV impacts the electrical system much differently than other forms of distributed generation. The impacts of PV to the generation and transmission system in steady-state conditions are well known and in the areas of uncertain demand, ramp rates and regulation requirements the utility can take mitigating measures for these attributes. The impacts during transient events such as unit trips or transmission and distribution faults are not widely recognized and are difficult for the utility to mitigate with conventional assets and operating changes.

This study focuses on the impacts of the roof-top PV during transient events and found the impacts to be very significant, causing significant degradations in system security and reliability. The study recommends measures that HELCO can utilize to mitigate the impacts of distributed PV during transient events. The study also identifies protective measures HELCO can implement to mitigate the impacts of increasing levels of PV. With changes to both system operations and system improvements, HELCO could reliably operate the system with current PV levels, and allow for greater amounts of PV to connect in the future. Without such measures, the impacts may not be acceptable.

To better illustrate the significance of the impact distributed PV has had on the HELCO system, prior to the rapid rise of Rule 14H compliant PV installations (2012 PV was estimated at 14 MW in 2012), the HELCO system could withstand faults of 15 cycles on all transmission lines and faults of 22 cycles on all transmission lines with lower communications reliability. With the recent addition of Rule 14H compliant PV (total of 40 MW in 1/2014; 60 MW expected 1/2015), faults in excess of 10 cycles have an extremely high risk of total system collapse.

The study indicates that without mitigating measures, and with the present amount of distributed PV on the system, severe degradation of the reliability of the HELCO transmission system and individual distribution circuits is possible. As the level of penetration increases, the risk of increased degradation in reliability and security for the system will also increase. The results clearly indicate a negative impact on system reliability and security as a direct result of the connection of large amounts of distributed PV.

For the system impacts, the study concluded the following:

- For total PV exceeding 60 MW of capacity, frequency control cannot be maintained with the minimum system generation during ramp events.
- For total PV exceeding 90 MW of capacity without increases in HELCO's reserve policy to increase minimum reserves, the generation cannot maintain frequency control during ramp events
- For routine system events (transmission level faults and trips of conventional or large wind plant generation), significant loss of customer load will occur as the result of PV tripping offline due to the frequency and voltage transient conditions during the event

(under-voltage and over-frequency). For some faults, the simulation resulted in loss of all under frequency load-shed circuits. Although in the simulation, following the 100% load shed the system became stable, the results indicate the system is very close to the stability limit, and indicates high potential for system failure if experienced in actual operation. Any event resulting in 100% of the underfrequency load shed scheme being activated is very extreme and presents a risk to the survival of the system.

- The analysis assumed PV control and protection systems operate correctly. The proper operation of PV control and protection systems is critical to the reliability of the HELCO power system. Periodic testing and performance verification should be initiated on all PV systems. PV that is in compliance with Rule 14 H performance criteria presents a severe risk to the security of the system which may be considered unacceptable at the penetration levels used in this study.
- The impact of PV on the Under Frequency Load Shedding (UFLS) system is significant and requires modification of the scheme to mitigate the impacts and improve system security. To match the system protection requirements to the load changes associated with distributed PV, adaptive load shedding may be necessary on all HELCO feeders.
- The loss of the distributed PV in the simulations during an under voltage or over frequency event increases the largest generation contingency by 300%. The capacity loss of PV will drive the operating and reserve requirements for the system during periods of PV production.

At the distribution circuit level, the following conclusions are included in the results of the study:

- When the penetration level of the distribution circuit reaches the study penetration levels (generation to minimum day load expressed in percent) the following mitigation steps must be considered.
 - **50%** - The ratio of minimum day load to generation level is 2.0. At this level of generation there is the possibility of developing over voltages due to the neutral shift for a line to ground fault. At this point, a grounding bank is strongly suggested.
 - **75%** - The ratio of minimum day load to generation level is 1.3. At this level of generation there is a stronger possibility of developing overvoltages due to the neutral shift for a line to ground voltage. At this point, a grounding bank is required and DTT is suggested. The substation protective relays will need to be upgraded to microprocessor based protection for the DTT.
 - **100%** - The ratio of minimum day load to generation level is 1.0. At this level of generation there is more possibility of developing overvoltages due to the neutral shift for a line to ground voltage and possible the load rejection. At this point, both a grounding bank and DTT is required.
 - **125%** - The ratio of minimum day load to generation level is 0.8. At this level of generation there is a strong possibility of developing overvoltages due to the neutral shift for a line to ground voltage. At this point, a grounding bank is required. Enough DG to stop the reverse power flow must be tripped prior to opening the distribution circuit breaker or DG must be curtailed to prevent the reverse flow.

PV impacts the protection systems and protection philosophy of the distribution, substation and transmission systems as the level of DG increases. These impacts can be summarized as follows:

- Temporary overvoltage conditions become a major concern as DG penetration exceeds 50% of the minimum day-time load.
- Replacing thermal generation with DG such as wind or PV decreases the fault current available to the system. Although this study indicates the reduction of fault current does not result in significant impacts to the protection system, in general a reduction of fault current has a tendency to result in more high impedance faults for the system. Certain other protection improvements are recommended in the body of the study

Although the scope of the study was an analysis on the impact of DG on the HELCO system, through evaluation of the results of the impact analysis, EPS recommends HELCO consider the following:

- HELCO should establish voltage and frequency ride through requirements for DG to ride through all transmission level faults, including faults that are not cleared by the primary protection and loss of conventional generation. This will ensure that breaker-failure, communications failure or other standard planning contingencies do not place the system at severe risk. This will require a change to Rule 14 H. Note that Rule 14 H should be fundamentally changed to a “ride-through” requirement as opposed to its current language which is based on IEEE 1547 requirements. IEEE 1547 requirements establish a minimum time to trip, as opposed to a minimum time to remain connected.
- HELCO should work with existing PV installations to review and change the voltage and frequency trip settings for all existing DG interconnections on the system to lessen the aggregate loss of distributed generation during system faults and contingencies.
- HELCO should develop an active UFLS scheme which can automatically adjust which feeders are on the different UFLS stages. This would be to ensure that the MW shed in each stage of UFLS corresponds to the UFLS design. Failure to adjust this can result in system failure for loss of generation events during periods of high solar PV production.
- The impact of increased DG ride-through capability for system protection should be evaluated against the distribution feeder protection impacts to establish the risk to the distribution system feeders. Failure to balance system requirements with feeder requirements may result in damaging conditions on the distribution feeder.
- The level of operating reserves using conventional generation should be derived from the contingency loss of PV as opposed to regulation or loss of a thermal unit.
- HELCO should investigate the use of stored energy devices to augment the system response during transient events. If the storage device can maintain frequency and voltage to levels that prevent the loss of PV, system reliability and security could be maintained. With a stored energy device, HELCO may be able to eliminate several of the recommendations below which are designed to mitigate the chance of PV tripping during transient events.
- All transmission breakers should be upgraded to 3 cycle breakers to minimize the fault clearing times.
- All transmission communications should be upgraded to prevent a single point of failure for any transmission fault protection and reduce the potential for secondary clearing times.
- Breaker-Failure relaying should be implemented at all generation and transmission stations.

2 Introduction

HELCO contracted with EPS to study the system at different levels of photovoltaic penetration on distribution circuits at levels of 50%, 75%, 100%, and 125% of the minimum day load. This study was performed with three different objectives in mind. First, system-wide analysis was performed to determine the limits on the HELCO system as a whole. This analysis included:

- Modeling the distributed generation
- Identifying the ramp rate requirements and restrictions that DG creates for conventional generation resources
- Identifying the regulation reserve requirements for conventional generation resources
- Identifying transient stability limitations caused by DG
- Identifying the steady-state restrictions caused by DG

The second objective was focused on the impacts that DG has on distribution circuits. Distribution circuit level analysis was performed to identify circuit issues with various levels of DG penetration. The distribution level analysis included:

- Analysis of DG impact on distribution voltage profile
- Analysis of DG impact on voltage flicker
- Impact that DG has on transformer tap change
- Analysis of power factor control of DG resources relates to system power factor, distribution circuit voltage profile, flicker, and transformer tap changes

The third objective was focused on the impacts that DG has on protection of the distribution, substation and transmission system as the level of DG increased. The analysis was broken into parts due to the scope and addressed in the order of issues that would come as the penetration level is increased. As the penetration level increases the main areas of concern are:

- Temporary overvoltage conditions that arise due to faults to ground
- Islanding
- Temporary overvoltages due to load rejection
- Reclosing

The analysis of the distribution system was the most extensive and includes the distribution protection of the substation as well the ground source. The topics follow a logical progression to cover the distribution protection. The substation transformer protection is next and the analysis looks at HELCO's existing practice and recommendations for improvement. The transmission system analysis reviews the existing protection system and what is required as the DG level increases.

EPS had previously produced a study for the Hawaiian utilities associated with the Reliability Standards Working Group (RSWG). The results from the RSWG study were relied upon for the completion of this study, and are referenced throughout this report.

3 Assumptions

3.1 Power Flow Load Model

EPS was provided with a PSS/E model of the HELCO grid contained within the PSS/E files “m2013nfa+AspenUpgrade+rev1+Final.sav” and “p2013nfa+AspenUpgrade+rev1+Final.sav”. The load for each substation was modeled as a single load connected to each distribution substation that would represent all feeders connected to that bus. The PSS/E tool is a positive sequence analysis tool that can be used to study both steady-state and transient stability system issues.

For the purposes of this study it was necessary to model the load associated with each feeder instead of using a single load to represent the total substation load. EPS used the 15-minute load data from the year 2008 to determine the relative load on each feeder compared to the total substation load. The year 2008 was selected since the feeder loads mostly pre-dated the recent increase in distributed photovoltaic generation at the feeder level. Hence, the load measured by the SCADA system was actual system load and was not the net load (equal to gross feeder load - DG on the feeder), as is measured on today’s system. When creating the system load model for feeders that had telemetry, the telemetered load values were used in the model. For tapped substations with feeders that did not have telemetry, but did have line measurements, the load was assumed to be evenly split between the feeders at the substation, and split between substations along the tapped line. The load along these tapped lines was split between substations based on substation transformer rating. For example, assume there is 10 MW of load along a tapped transmission line with two substations with one step-down transformer at each substation. Assuming that one transformer has a rating of 10 MVA and the other has a rating of 5 MVA. The load connected to the 10 MVA transformer would be 6.67 MW while the 5 MVA transformer would be 3.33 MW.

Based on the 2008 system loading it is reasonable to assume that the system load near the noon time frame (times at which the PV generation could be near maximum) ranged from approximately 145 MW to 175 MW in 2008. After the load was split up on a feeder-by-feeder basis, each load was scaled up or down by a fixed percentage to setup the power flow cases with the different system loading levels. HELCO’s observable system load has been decreasing due to the increase in distributed generation. This study used the 2008 “actual” system daytime load levels, and added the distributed generation at the required levels. Since HELCO has more than 20 MW of DG capacity installed in year 2013, the daytime minimum loading is difficult to determine without knowing the total DG that is online. HELCO does calculate the approximate amount of DG in real time using PV sensors spread throughout their system, but this calculation is not performed on a feeder-by-feeder basis as needed for some of the analysis performed during this project.

3.2 Power Flow Photovoltaic Model

EPS received a photovoltaic capacity spreadsheet titled “DG_Totals_Freq_Current.xls” which was updated 2/1/2013, and contains the total amount of DG capacity installed on the HELCO system as well as predictions of the DG that will be installed. The data is provided on a circuit-by-circuit basis. EPS has made the following assumptions regarding the DG installed on the system:

- 4.76 MW of DG generation is set to trip offline due to under-frequency protection at a frequency of 59.3 Hz, in accordance with IEEE Standard 1547. No additional DG will be connected to the system with these settings.

- The remaining DG is set to trip offline due to under-frequency protection at a frequency of 57.0 Hz.
- All DG is set to trip offline due to over-frequency protection at a frequency of 60.5 Hz.
- The DG is assumed to be generating at a power factor of 1.0, and does not have the capability to provide voltage support.
- The DG will trip according to the IEEE 1547 under-voltage trip settings with pickup voltages of 0.88 and 0.5 per-unit voltage. It will also observe the over-voltage trip settings of 1.1 and 1.2 per-unit voltage.

The DG was added to the HELCO system model as a negative load with a power factor of 1.0. When converted for transient stability analysis, these loads were modeled as constant current sources. Using the "DG_Totals_Freq_Current.xls" spreadsheet dated 2/1/2013, the DG was assigned to the HELCO feeders using the total of the currently installed DG plus the planned distributed generation totals listed in the "Merge Totals" tab. A negative load was added for each feeder to represent this distributed generation for system-wide studies. Initially the load was added at a total of 43 MW, however the DG was scaled on a percentage basis for all feeders to get to higher or lower DG penetration levels.

3.3 Dynamic Simulation Photovoltaic Generation Model

The primary impact that the DG will have on the dynamic simulations run for this study will be the tripping of the DG. The DG was setup to trip 4.76 MW based on under-frequency protection at 59.3 Hz with the rest tripping at a frequency of 57.0 Hz. The DG was also setup to trip according to the IEEE 1547 over-voltage and under-voltage trip settings. The DG was assigned to various zones depending on the feeder to which it is connected. The DG was added to the model in five different zones. These zones were used to ensure that the distributed generation that is connected on feeders that are part of the under-frequency load shedding (UFLS) scheme will be tripped offline should the UFLS scheme operate. These zones were created to properly model the timing and size of DG and load trips related to the UFLS system.

- Zone 89 – This zone encompasses all the DG that is connected to feeders that are not used in the HELCO UFLS scheme. The DG in this zone would only use protection settings specified in IEEE 1547.
- Zone 81 – This zone encompasses all the DG that is connected to feeders that are in UFLS stage 1. The load representing the DG in this zone would have the same trip settings as specified in IEEE 1547, but would additionally have the same under-frequency trip settings as the UFLS stage 1 loads.
- Zone 82 – This zone encompasses all the DG that is connected to feeders that are in UFLS stage 2. The load representing the DG in this zone would have the same trip settings as specified in IEEE 1547, but would additionally have the same under-frequency trip settings as the UFLS stage 2 loads.
- Zone 83 – This zone encompasses all the DG that is connected to feeders that are in UFLS stage 3. The load representing the DG in this zone would have the same trip settings as specified in IEEE 1547, but would additionally have the same under-frequency trip settings as the UFLS stage 3 loads.
- Zone 84 – This zone encompasses all the DG that is connected to feeders that are in UFLS stage 4. The load representing the DG in this zone would have the same trip

settings as specified in IEEE 1547, but would additionally have the same under-frequency trip settings as the UFLS stage 4 loads.

Setting the under-frequency and under-voltage protection up in this manner ensured that the net amount of load shedding was correctly represented as the amount of DG connected to the system was varied throughout this study. It also ensures that the amount of DG that trips offline at a frequency of 59.3 is correctly accounted for when simulating system frequency disturbances.

3.4 Power Flow Dispatch Cases

EPS has relied on some conclusions from the RSWG project with regards to the minimum number of conventional generation units that must be online within the HELCO system. The RSWG project evaluated the stability limits of the HELCO system. In order to meet the ramp rate requirements, maintain the maximum rate of change of frequency, and prevent violations to the HELCO transmission planning criteria, a minimum set of units was defined. The following rules for minimum generating unit combinations were followed for each power flow commitment / dispatch used in this study. The minimum unit commitments limited the total amount of DG that can interconnect to the system based on the total system load and the minimum generation capabilities of the generators. The minimum unit configurations are shown below in Table 1.

Table 1: Minimum Unit Configurations as Defined in RSWG Study

Requirement Description	Number of Large Units
Base Condition: Two large steam units* + 1CTCC at Keahole	4
1CTCC at Keahole + 1CTCC at HEP	4
1CTCC + 1 large steam unit + 1 Simple Cycle CT	4
3 large steam units (No combustion turbine generation)	3
2 large steam units + 1 CT (exception: Hill 5)	3
1 large steam unit + 1CTCC (exception: Hill 5)	3
*Large steam unit = Hill 5, Hill 6, Puna Steam, Hu Honua, 2 Shipman Units	

These minimum generation dispatch scenarios were defined to prevent a decrease in reliability as defined by IEEE. The largest contingency in a system should produce similar system responses both before and after system changes under consideration. To evaluate the system reliability for planning cases used during the RSWG project the following requirements were used:

- Additional under frequency load shedding should be avoided
- Excessive rate of change of frequency should be prevented
- Transmission voltages and loading should be within the transmission planning voltage and loading criteria

During the course of this study, additional requirements based on the addition of large amounts of solar generation were evaluated.

The impact of the distributed solar generation can be seen by analyzing some of the historical load data that was provided by HELCO. Figure 1 shows the daily load profile for January for the years 2008, 2012, and 2013.

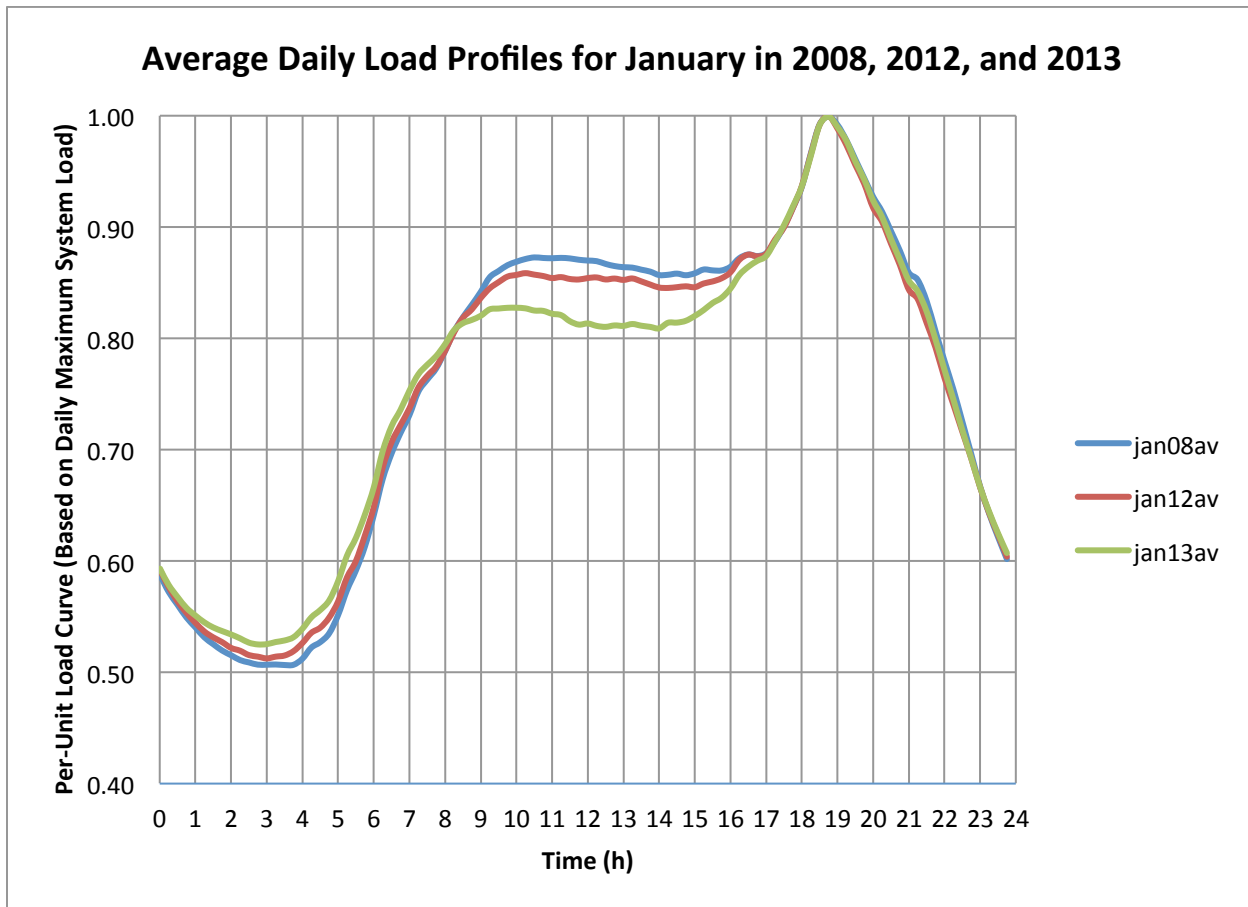

Figure 1: January Daily Load Profiles for 2008, 2012, and 2013

Figure 1 shows the average daily load curve for January for 2008, 2012, and 2013. The data used for this chart is taken from the 15-minute total generation as taken from the HELCO SCADA system. Each day of the month was “per-unitized” by setting the maximum load during the day as 1.0, and putting each 15-minute sample on the daily peak base. For example, if the evening peak of 180 MW occurred at 6:30 pm, a noon load of 140 MW would have a per-unitized value of 0.778. Next, the daily “per-unit” load for each 15-minute time frame was averaged across the 31 days of the month. The result is an “average” load curve for the month. The significant difference seen during the daytime hours, when the PV generation is high, shows the average amount of generation provided by PV for January. It is also telling that the difference between 2008 and 2012 is much smaller than the difference between 2012 and 2013 confirming that the amount of DG on the system is growing much more rapidly than in the past. As the connected DG capacity continues to increase, the impact to the system operations will also increase.

4 HELCO Steady State Analysis

EPS was provided with a power flow database in PSS/E savecase format. This power flow database modeled the full 69 kV and 34.5 kV transmission system, but did not model the 12.5 kV distribution system. As detailed earlier in section 3.1, the load was split up to represent each feeder on the HELCO system. Many power flow dispatch cases were created with varying levels of DG generation and system load online. The load case naming convention was used to convey information about the case. The case name uses the first three numerals to give the

system load level (145, 155, 165, 175). Next is a single letter which can describe the dispatch scenario ('a', 'b', 'c', etc.). Dispatch scenario 'a' was setup with combustion turbine generation dispatched with minimal steam generation. Scenario 'b' was setup with steam turbines dispatched. Scenario 'c' was setup with steam and combustion turbine generation. Scenario 'd' was setup with minimal steam generation, high as-available generation, and minimal regulating reserve. The final numerals describe how many MW of distributed DG generation is online in the power flow case (30, 40, 50 etc.) So case 145a30 would have 145 MW of system load, would use dispatch scenario 'a', and have 30 MW of distributed solar online. The following tables show the total generation dispatch scenarios used in the study.

Table 2: Scenario 'A' Dispatch Cases

Load Level	145	155	165	175	145	155	165	175	145	155	165	175	145	155	165	175
Scenario	a	a	a	a	a	a	a	a	a	a	a	a	a	a	a	a
PV Gen	0	0	0	0	30	30	30	30	40	40	40	40	50	50	50	50
H6																
H5																
Puna																
S3																
S4																
Kano CT1																
Keah CT2																
Puna CT3				10.0						12.0						
Keah 1CTCC					18.8	20.0	23.8		21.3	22.5	21.3	23.8	20.0	22.5	17.5	21.3
Keah 2CTCC	37.8	45.9	48.6	48.6				43.2								
HEP 1CTCC									27.4	24.5			22.4	26.0		
HEP 2CTCC	53.4	53.4	57.7	57.7	43.3	49.0	53.4	44.7			47.6	53.4			43.3	46.2
HuHonua	16.0	17.0	19.0	19.0	14.0	17.0	19.0	16.0	17.0	17.0	17.0	18.0	16.0	17.0	16.0	17.0
PGV	31.5	31.6	32.8	31.4	32.8	32.7	32.8	31.2	32.2	31.5	31.2	31.7	29.0	31.5	29.8	30.4
Waiau	0.1	0.1	0.1	0.1	0.1	0.1	0.1	0.1	0.1	0.1	0.1	0.1	0.1	0.1	0.1	0.1
Waiau	0.1	0.1	0.1	0.1	0.1	0.1	0.1	0.1	0.1	0.1	0.1	0.1	0.1	0.1	0.1	0.1
Puueo	0.1	0.1	0.1	0.1	0.1	0.1	0.1	0.1	0.1	0.1	0.1	0.1	0.1	0.1	0.1	0.1
Puueo	0.5	0.5	0.5	0.5	0.5	0.5	0.5	0.5	0.5	0.5	0.5	0.5	0.5	0.5	0.5	0.5
Wailuku	2.0	2.0	2.0	2.0	2.0	2.0	2.0	2.0	2.0	2.0	2.0	2.0	2.0	2.0	2.0	2.0
Wailuku	2.0	2.0	2.0	2.0	2.0	2.0	2.0	2.0	2.0	2.0	2.0	2.0	2.0	2.0	2.0	2.0
HRD	1.0	1.0	1.0	1.0	1.0	1.0	1.0	1.0	1.0	1.0	1.0	1.0	1.0	1.0	1.0	1.0
Apollo	2.0	2.0	2.0	2.0	2.0	2.0	2.0	2.0	2.0	2.0	2.0	2.0	2.0	2.0	2.0	2.0
Load	146	156	166	174	147	156	167	173	146	155	165	175	145	155	164	173
Spin	31.3	22.2	13.2	22.2	33.5	23.5	13.4	34.6	12.3	21.0	23.7	14.4	19.6	12.5	32.7	25.1
Dn Reg	75.2	84.4	94.6	96.2	54.3	64.2	74.4	71.6	52.9	55.5	62.5	72.3	42.4	52.0	52.1	60.3

The dispatch cases in scenario 'a' represent the HELCO system when the load is primarily supplied by the combustion turbines, HuHonua, and PGV. These dispatch cases have low as-available generation.

Table 3: Scenario 'B' Dispatch Cases

Load Level	145	155	165	175	145	155	165	175	145	155	165	175	145	155	165	175
Scenario	b	b	b	b	b	b	b	b	b	b	b	b	b	b	b	b
PV Gen	0	0	0	0	30	30	30	30	40	40	40	40	50	50	50	50
H6	18.9	19.9	17.7	17.4	16.3	17.0	19.7	16.9	15.1	15.5	17.5	15.7	13.9	15.3	16.8	13.5
H5	12.0	13.0	10.0	11.0	12.0	11.0	12.0	12.0	10.0	11.0	12.0	11.0	10.0	9.0	11.0	10.0
Puna	14.0	14.0	12.0	12.0	13.0	12.0	14.0	14.0	12.0	12.5	14.0	12.0	10.0	10.0	12.0	11.0
S3																
S4																
Kano CT1																
Keah CT2																
Puna CT3						12.0	12.0									
Keah 1CTCC	21.3	25.0			21.3	20.0	22.5	22.5	18.8	21.3	23.8	20.0	16.3	17.5	20.0	17.5
Keah 2CTCC			45.9	48.6												
HEP 1CTCC	26.0	27.4	23.1	27.4				26.0				23.1				21.6
HEP 2CTCC																
HuHonua	18.0	19.0	17.0	19.0	16.0	16.0	18.0	16.0	12.0	16.0	19.0	15.0	12.0	14.0	16.0	14.0
PGV	32.0	33.6	32.9	31.5	32.0	33.6	34.0	31.5	32.0	33.6	34.0	31.5	27.0	33.6	34.0	30.0
Waiau	0.1	0.1	0.1	0.1	0.1	0.1	0.1	0.1	0.1	0.1	0.1	0.1	0.1	0.1	0.1	0.1
Waiau	0.1	0.1	0.1	0.1	0.1	0.1	0.1	0.1	0.1	0.1	0.1	0.1	0.1	0.1	0.1	0.1
Puueo	0.1	0.1	0.1	0.1	0.1	0.1	0.1	0.1	0.1	0.1	0.1	0.1	0.1	0.1	0.1	0.1
Puueo	0.5	0.5	0.5	0.5	0.5	0.5	0.5	0.5	0.5	0.5	0.5	0.5	0.5	0.5	0.5	0.5
Wailuku	2.0	2.0	2.0	2.0	2.0	2.0	2.0	2.0	2.0	2.0	2.0	2.0	2.0	2.0	2.0	2.0
Wailuku	2.0	2.0	2.0	2.0	2.0	2.0	2.0	2.0	2.0	2.0	2.0	2.0	2.0	2.0	2.0	2.0
HRD	1.0	1.0	1.0	1.0	1.0	1.0	1.0	1.0	1.0	1.0	1.0	1.0	1.0	1.0	1.0	1.0
Apollo	2.0	2.0	2.0	2.0	2.0	2.0	2.0	2.0	2.0	2.0	2.0	2.0	2.0	2.0	2.0	2.0
Load	150	160	166	175	148	159	170	177	148	158	168	176	147	157	168	175
Spin	16.9	8.7	30.3	20.6	20.0	29.5	19.3	19.6	30.7	22.3	12.3	30.2	36.4	32.7	22.7	39.4
Dn Reg	87.1	83.9	81.6	89.9	51.6	55.6	66.2	70.9	40.9	50.9	61.3	60.3	30.2	40.4	50.8	49.6

The dispatch cases in scenario 'b' represent the HELCO system when the load is primarily supplied by the steam turbines, combined cycle generation, HuHonua, and PGV. These dispatch cases also have low as-available generation.

Table 4: Scenario 'C' Dispatch Cases

Load Level	145	155	165	175	145	155	165	175	145	155	165	175	145	155	165	175
Scenario	c	c	c	c	c	c	c	c	c	c	c	c	c	c	c	c
PV Gen	0	0	0	0	30	30	30	30	40	40	40	40	50	50	50	50
H6																
H5	12.4	12.5	12.1	11.4	10.5	11.8	13.3	11.2	9.4	11.1	11.8	10.6	6.8	6.6	8.2	11.4
Puna	12.0	13.0	13.0	13.0	10.0	12.0	10.0	10.0	10.0	12.0	12.0	11.0	7.0	7.0	9.0	12.0
S3																
S4																
Kano CT1																
Keah CT2																
Puna CT3			10.0													8.0
Keah 1CTCC	17.5	21.3	23.8		16.3	17.5	15.0	18.8	13.8	15.0	20.0	16.3	10.0	13.8	16.3	15.0
Keah 2CTCC				40.5												
HEP 1CTCC	23.1	25.2	23.1	24.5			17.3	21.6				18.8				
HEP 2CTCC																
HuHonua	15.0	17.5	17.0	16.0	12.0	17.5	12.0	15.0	10.0	15.0	12.0	14.0	10.0	15.0	12.0	14.0
PGV	32.0	32.0	32.9	31.5	32.0	32.0	32.9	31.5	27.0	27.0	34.0	27.0	27.0	27.0	34.0	28.0
Waiau	0.2	0.2	0.2	0.2	0.2	0.2	0.2	0.2	0.2	0.2	0.2	0.2	0.2	0.2	0.2	0.2
Waiau	0.5	0.5	0.5	0.5	0.5	0.5	0.5	0.5	0.5	0.5	0.5	0.5	0.5	0.5	0.5	0.5
Puueo	0.5	0.5	0.5	0.5	0.5	0.5	0.5	0.5	0.5	0.5	0.5	0.5	0.5	0.5	0.5	0.5
Puueo	1.5	1.5	1.5	1.5	1.5	1.5	1.5	1.5	1.5	1.5	1.5	1.5	1.5	1.5	1.5	1.5
Wailuku	4.0	4.0	4.0	4.0	4.0	4.0	4.0	4.0	4.0	4.0	4.0	4.0	4.0	4.0	4.0	4.0
Wailuku	4.0	4.0	4.0	4.0	4.0	4.0	4.0	4.0	4.0	4.0	4.0	4.0	4.0	4.0	4.0	4.0
HRD	8.4	8.5	9.0	9.5	8.4	8.5	9.0	9.5	8.4	8.5	9.0	9.5	8.4	8.5	9.0	9.5
Apollo	20.0	20.0	20.0	20.0	20.0	20.0	20.0	20.0	20.0	20.0	20.0	20.0	19.0	20.0	20.0	20.0
Load	151	161	171	177	150	160	170	178	149	159	169	178	149	159	169	179
Spin	26.5	17.0	26.6	30.1	29.3	19.2	38.9	29.9	34.9	24.9	22.2	35.9	44.2	35.7	32.6	36.6
Dn Reg	67.0	65.5	68.8	71.9	33.8	43.8	44.5	52.1	23.2	33.1	42.8	41.6	13.8	22.4	32.5	34.4

The dispatch cases in scenario 'c' represent the HELCO system when the load is primarily supplied by the small steam turbines, combined cycle generation, HuHonua, and PGV. These dispatch cases have high as-available generation.

Table 5: Scenario 'D' Dispatch Cases

Load Level	145	155	165	175	145	155	165	175	145	155	165	175	145	155	165	175
Scenario	d	d	d	d	d	d	d	d	d	d	d	d	d	d	d	d
PV Gen	0	0	0	0	30	30	30	30	40	40	40	40	50	50	50	50
H6																
H5																
Puna																
S3																
S4																
Kano CT1																
Keah CT2																
Puna CT3	15.0		10.0	17.0			12.5									
Keah 1CTCC	22.5	21.3	23.8		16.3	21.3	18.8		15.0	17.5	19.4		13.8	15.0	16.3	18.8
Keah 2CTCC				45.9				35.1				32.4				
HEP 1CTCC	24.5			26.0	20.2	20.2	20.2	23.1	14.4	17.3	21.6	20.2	13.0	15.9	17.3	21.6
HEP 2CTCC		49.8	47.6													
HuHonua	17.0	17.5	17.0	17.0	14.0	14.0	14.0	16.0	12.0	13.0	15.0	14.0	9.9	11.0	12.5	16.0
PGV	31.9	32.4	32.4	30.2	29.1	33.5	34.2	31.4	27.8	31.0	32.6	28.7	22.1	26.5	32.4	30.0
Waiau	0.2	0.2	0.2	0.2	0.2	0.2	0.2	0.2	0.2	0.2	0.2	0.2	0.2	0.2	0.2	0.2
Waiau	0.5	0.5	0.5	0.5	0.5	0.5	0.5	0.5	0.5	0.5	0.5	0.5	0.5	0.5	0.5	0.5
Puueo	0.5	0.5	0.5	0.5	0.5	0.5	0.5	0.5	0.5	0.5	0.5	0.5	0.5	0.5	0.5	0.5
Puueo	1.5	1.5	1.5	1.5	1.5	1.5	1.5	1.5	1.5	1.5	1.5	1.5	1.5	1.5	1.5	1.5
Wailuku	4.0	4.0	4.0	4.0	4.0	4.0	4.0	4.0	4.0	4.0	4.0	4.0	4.0	4.0	4.0	4.0
Wailuku	4.0	4.0	4.0	4.0	4.0	4.0	4.0	4.0	4.0	4.0	4.0	4.0	4.0	4.0	4.0	4.0
HRD	8.4	8.5	9.0	9.5	8.4	8.5	9.0	9.5	8.4	8.5	9.0	9.5	8.4	8.5	9.0	9.5
Apollo	20.0	20.0	20.0	20.0	20.0	20.0	20.0	20.0	20.0	20.0	20.0	20.0	20.0	20.0	20.0	20.0
Load	150	160	170	176	149	158	169	176	148	158	168	175	148	158	168	177
Spin	18.0	21.0	30.2	20.1	27.6	22.6	31.6	32.8	36.6	30.2	22.0	40.4	41.4	36.1	31.9	21.6
Dn Reg	70.9	66.4	69.2	75.1	43.5	43.9	47.6	51.6	29.2	33.8	43.6	41.3	17.8	23.4	33.5	41.4

The dispatch cases in scenario 'd' represent the HELCO system when the load is primarily supplied by the combustion turbines, HuHonua, and PGV. These dispatch cases have high as-available generation.

In addition to the dispatch scenarios 'a', 'b', 'c', and 'd', we created a set of cases that represent the maximum allowable DG penetration based on the minimum number of units referenced in the RSWG report. The dispatch case list is shown below in Table 6.

Table 6: Maximum DG Dispatch Cases

Load Level	145	145	145	145	145	145
Scenario	a	b	c	d	e	f
PV Gen	70	80	75	75	70	80
H6				13.8	16.0	
H5	6.6		8.6	8.0		
Puna				9.0		
S3						
S4						
Kano CT1						
Keah CT2						
Puna CT3			8.0		10.0	
Keah 1CTCC	15.0	11.1	11.3			12.5
Keah 2CTCC						
HEP 1CTCC		12.5				
HEP 2CTCC						
HuHonua	10.0				10.0	10.0
PGV	25.0	24.9	25.0	25.0	25.0	24.9
Waiau	0.2	0.2	0.2	0.2	0.2	0.2
Waiau	0.5	0.5	0.5	0.5	0.5	0.5
Puueo	0.5	0.5	0.5	0.5	0.5	0.5
Puueo	1.5	1.5	1.5	1.5	1.5	1.5
Wailuku	3.0	2.0	2.0	2.0	2.0	2.0
Wailuku	3.0	2.0	3.0	2.0	2.0	2.0
HRD	2.0	2.0	2.0	2.0	2.0	2.0
Apollo	8.0	7.5	8.0	8.0	8.0	9.0
Load	145	145	146	147	148	145
Spin	31.4	32.8	32.7	21.2	28.0	27.0
Dn Reg	15.6	10.6	11.9	10.8	13.0	11.4

These maximum DG cases are the worst-case generation dispatch cases with load levels at 145 MW and have system-wide DG penetration levels near 50%. It is possible for higher penetration levels to be achieved with significant system improvements. However, increasing the system-wide penetration beyond these levels would violate the RSWG minimum generation criteria and is outside the scope of this study. Furthermore, as detailed in this report, significant system issues are evident with these system-wide penetration levels. This study did analyze many of the impacts of higher DG penetration on a circuit-by-circuit basis.

4.1 Contingency Analysis

EPS performed steady state contingency analysis to ensure that all system elements are within the requirements in the HELCO transmission planning criteria with regard to line flow limits and bus voltage requirements. The contingencies studied included every 69 kV transmission line, every 69/34.5 kV transformer, and every 34.5 kV line. For the HELCO 69 kV lines with tapped load(s), the line section closest to the breaker was taken out of service while all the tapped load(s) were served from the opposite end of the line. This resulted in the worst case scenario for determining both line loading and bus voltage limits.

There were no voltage or flow violations on the HELCO system for any outage studied. This is due to the fact that the transmission system was designed to prevent overloads at the peak system load, which is significantly higher than the daytime load, especially when the distributed generation is reducing the loading on the transmission system. There were, however, a few cases and contingencies that had line flows that were near the rated capacity, and are shown below in Table 7.

Table 7: 7100 Line Outage Causing High Flows

Case 155b											
BRANCH							OUTAGE	MVAFLOW	AMPFLOW	RATE A	% FLOW
8450	HUEHUE	69	8470	PUUWAAWA	69	1	7100	34.03	33.95	32.00	106.10
8470	PUUWAAWA	69	8480	PUUHULU	69	1	7100	34.13	34.02	32.00	106.30
8480	PUUHULU	69	8700	KEAMUKU	69	1	7100	34.42	33.90	32.00	105.94

Table 7 shows the heavy flows on line 6800 between Huehue substation and Keamuku substation. This line conductor is 2/0 ACSR and has an emergency rating equivalent to 36 MVA. From the "MVAFLOW" column it can be seen that the flow on the 6800 line is above the normal 32 MVA limit but below the 36 MVA emergency limit. Increasing generation at the Keahole substation would reduce the flow along this line. No dispatch case with distributed generation online had line flow or bus voltage violations. In general, the addition of distributed generation to the system reduces the steady state line flow issues due to the reduced transmission system usage.

4.2 Breaker Angle Analysis

EPS performed additional steady state analysis that examined the voltage angles across open breakers during transmission line reclosing attempts. All of the 34 kV and 69 kV HELCO transmission breakers have a permissive synchro-check relay that confirms that the voltage and angle on each side of the breaker are within tolerance for a set period of time before allowing the breaker to close. There are two setting groups, the most common group has the line angle set at 20 degrees while the other setting group has the line angle set at 30 degrees. The relays set at 30 degrees are located in locations that experience large line angles when open. There are several 69 kV breakers at Kanoelehua that have unique settings and must be manually synchronized since they are associated with Hill 5 and 6.

Several of the lines on the HELCO system are susceptible to a large breaker angle across the open breaker. When this happens, the breaker will not close back in until HELCO operations changes the generation dispatch to meet the synch-check permissive requirements thereby allowing the breaker to close. With this constraint in mind, each line section was evaluated to determine the voltage angle for each open breaker on the HELCO transmission system as well as the steps that would be required by operations to successfully close the breaker. The following two tables show the results of this breaker angle analysis.

Table 8: Breaker Angle Analysis Results 1 of 2

Case	Line	From Bus	To Bus	Angle	Resolution
145a	7700	Haina	Puukapu	36.2	Maximize Keahole Generation
145a30	7700	Haina	Puukapu	34.6	Maximize Keahole Generation
145b	7700	Haina	Puukapu	32.4	Maximize Keahole Generation
145c	9600	Kamaoa	Kapua	34.4	Turn on Keahole Diesels, reduce Tawhiri by 5 MW
145c30	9600	Kamaoa	Kapua	32.8	Maximize Keahole Generation
145c40	9600	Kamaoa	Kapua	31.7	Maximize Keahole Generation
145c50	9600	Kamaoa	Kapua	30.2	Maximize Keahole Generation
145d	9600	Kamaoa	Kapua	32.3	Turn on Keahole Diesels, reduce Tawhiri by 5 MW
155a	7700	Haina	Puukapu	35.7	Maximize Keahole Gen., Turn on Keahole Diesels
155a30	7700	Haina	Puukapu	38.1	Maximize Keahole Gen., Turn on Keahole Diesels
155b	7700	Haina	Puukapu	33.3	Maximize Keahole Gen., Turn on Keahole Diesels
155b	6300	Puna	Panaewa	33.2	Turn on Keahole Diesels, Reduce Puna to 8, Increase HEP and Hu Honua Generation
155c	9600	Kamaoa	Kapua	34.7	Maximize Keahole Gen, reduce Tawhiri by 5 MW
155c30	9600	Kamaoa	Kapua	34.5	Maximize Keahole Gen., Turn on Keahole Diesels
155c40	9600	Kamaoa	Kapua	33.3	Maximize Keahole Generation
155c50	9600	Kamaoa	Kapua	31.4	Maximize Keahole Generation
155d	7700	Haina	Puukapu	30.9	Maximize Keahole Gen., Turn on Keahole Diesels, 1 diesel @ Waimea, Reduce HEP by 3 MW
155d	9600	Kamaoa	Kapua	39	Maximize Keahole Generation

Table 8 shows the breaker angle analysis results for the cases with 145 and 155 MW of system load. The breaker angle issues can all be resolved with the combination of re-dispatch, and bringing some diesel units online. Starting a larger unit is not required for any of the cases studied. Lines 7700, 9600, and 6300 each had breaker angles in excess of 30 degrees. The steps that would be required by operations in order to reduce these angles below 30 degrees are shown in the “Resolution” column. In general, the addition of distributed generation reduced the voltage angles across open breakers particularly considering that more DG is generating on the west side of the island and each of these lines have large angles when there is large east to west flow.

Table 9: Breaker Angle Analysis Results 2 of 2

Case	Line	From Bus	To Bus	Angle	Resolution
165a	7700	Haina	Puukapu	37.2	Maximize Keahole Gen., Turn on Waimea Diesels
165a30	7700	Haina	Puukapu	39.2	Maximize Keahole Gen., Turn on Waimea Diesels, 2 diesels @ Keahole, Reduce HEP to 44 MW
165a40	7700	Haina	Puukapu	38.0	Maximize Keahole Gen., Turn on Keahole Diesels
165a50	7700	Haina	Puukapu	34.8	Maximize Keahole Gen., Turn on Keahole Diesels
165c	9600	Kamaoa	Kapua	36.8	Maximize Keahole Gen., Turn on Keahole Diesels, Curtail Tawhiri Generation to 15 MW
165c30	9600	Kamaoa	Kapua	34.2	Maximize Keahole Gen., Curtail Tawhiri Gen by 5
165c40	9600	Kamaoa	Kapua	33.7	Maximize Keahole Gen., Curtail Tawhiri Gen by 5
165c50	9600	Kamaoa	Kapua	33.0	Maximize Keahole Gen., Curtail Tawhiri Gen by 5
165d	7700	Haina	Puukapu	40.0	Maximize Keahole Gen., Turn on Waimea Diesels, 1 diesel @ Keahole, Reduce HEP to 42 MW
165d	9600	Kamaoa	Kapua	32.6	Maximize Keahole Gen., Curtail Tawhiri Gen by 5
165d30	9600	Kamaoa	Kapua	32.5	Maximize Keahole Gen., Curtail Tawhiri Gen by 5
175a	7700	Haina	Puukapu	38.7	Maximize Keahole Gen., Turn on Waimea Diesels, Increase CT3 by 2 MW, Reduce HEP to 46 MW
175a30	7700	Haina	Puukapu	32.0	Maximize Keahole Gen., Turn on Keahole Diesels
175a40	7700	Haina	Puukapu	39.0	Maximize Keahole Gen., Turn on Waimea Diesels, 2 diesels @ Keahole, Reduce HEP to 44 MW
175a50	7700	Haina	Puukapu	37.4	Maximize Keahole Gen., Turn on Keahole Diesels
175a30	7700	Haina	Puukapu	31.8	Maximize Keahole Gen., Turn on Keahole Diesels
175c	9600	Kamaoa	Kapua	31.0	Maximize Keahole Gen., Curtail Tawhiri Gen by 5
175c30	9600	Kamaoa	Kapua	34.0	Maximize Keahole Gen., Curtail Tawhiri Gen by 5
175c40	9600	Kamaoa	Kapua	33.5	Maximize Keahole Gen., Curtail Tawhiri Gen by 5
175c50	9600	Kamaoa	Kapua	35.8	Maximize Keahole Gen., Curtail Tawhiri Gen by 5

Table 9 shows the breaker angle analysis for cases with 165 and 175 MW of system load. With a higher load level, the angles across open breakers were larger compared to the cases with 145 and 155 MW of load. The larger angles require more effort from system operations in order to reduce the breaker angles below the 30 degree threshold. Even so, the worst case breaker angles were resolved without the need to start any large units. Starting large units would take a significant amount of time and would put the system at greater risk of severe system consequences if another outage were to occur while one of the breakers is unable to close. The system operator can attempt to close the breaker, but may not always know why the breaker failed to close since the breaker could also fail due to equipment failure. Identifying a line angle issue can be difficult in real-time operations, and is of concern. The system operator would only perform the mitigation steps listed above if the system operator suspects that the breaker failure to close is due to the line angle.

4.3 Steady State Distribution Voltage Analysis

The previous sections have focused on system-wide, steady-state issues caused by the addition of distributed generation. The addition of generation on the distribution system has more localized impacts. One of these localized impacts is the change in the distribution circuit voltage profile. Determining the impact that the DG penetration level has on the voltage profile along the distribution circuits was accomplished by running power flows for each distribution circuit. HELCO provided EPS with two sets of drawings with which we could approximate the 12.5 kV distribution circuit impedance. The first set contained GIS drawings showing the geographical depiction of the feeder. The second set of drawings provided was a set of distribution one-line diagrams. These two sets of drawings were used to estimate the impedance between the distribution substation and the end of the feeder. This analysis calculated the worst case feeder impedance at the very end of a lateral tap off the main feeder. Unless the distribution one-lines specified the circuit conductor, the analysis assumed that the main feeder length for each feeder was constructed with 336 AAC conductor, and the laterals are constructed using 1/0 AAC cable. With the feeder lengths and conductor types we were able to estimate the largest impedance along the feeder.

The voltage profile analysis is very dependent on where both the load and the DG is located along the feeder. Since it would have been difficult to perform a complete distribution circuit voltage analysis for each circuit, we used a standardized approach with varied combinations of load and DG locations. This allowed us to identify each circuit that has the potential for high or low voltages associated with the location of feeder load and distributed generation.

The feeders were split up in the power flow case in 4 equal segments such that each segment represented 25% of the total feeder impedance. A simple one line showing the configuration is shown below in Figure 2. Since the distribution of load along the feeder length is not known, several load configurations were looked at to bracket the realistic load distributions along the feeder length. These configurations are shown in Table 10 below.

Table 10: Load Distribution

Configuration	Load at Percent of Line Length				
	@ 0%	@ 25%	@ 50%	@ 75%	@ 100%
Beginning	100%	0%	0%	0%	0%
End	0%	0%	0%	0%	100%
Increasing	3%	6%	13%	26%	52%
Decreasing	52%	26%	13%	6%	3%
Even	20%	20%	20%	20%	20%

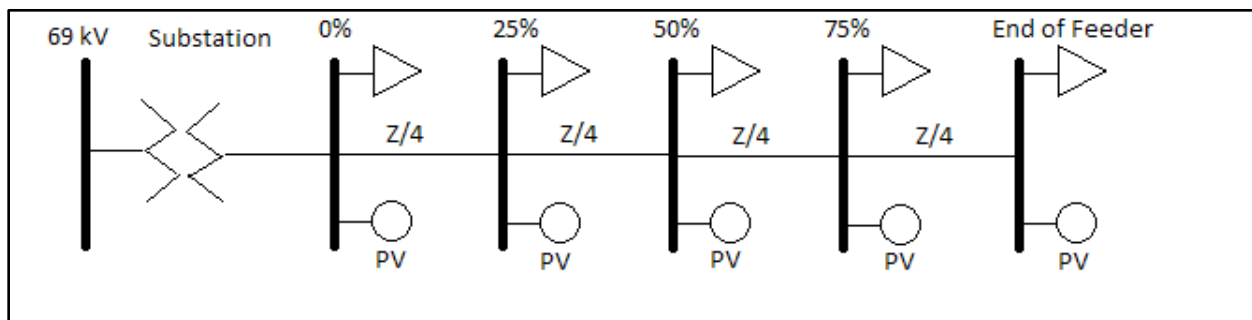

Figure 2: Distribution Circuit Configuration for Voltage Profile Analysis

The increasing configuration represents a feeder that has the majority of the load located at the end of the feeder, with the percentage of total feeder load increasing along the length of the feeder. The “Beginning” configuration assumes that all of the load is located at the substation. The actual load distribution will be somewhere between the “Beginning” and “End” configurations.

The DG was also distributed along the feeder length using the same configurations. The result was that there were 25 different combinations of load and DG distribution that were studied. In addition, five different DG penetration levels of 0%, 50%, 75%, 100%, and 125% were studied based on the minimum yearly load on the feeder between 9:00 AM and 5:00 PM. This resulted in 105 power flow cases (5 at 0% penetration and 25 for each penetration level between 50% and 125%) for each distribution feeder.

This approach of varying the load and DG distribution along the feeder provides a guideline as to which feeders could potentially have some steady-state voltage issues. If, for example, a feeder could accept 125% DG penetration with all the combinations of load and DG location, the circuit is not limited by distribution voltage profile. However, if some of the load/DG locations result in voltage violations, HELCO could specify those feeders for further analysis. The additional analysis would determine the steady state voltage impacts from the distributed DG as the amount of DG increases. Stated another way, this analysis approach will not specify what level of distributed generation can cause steady state voltage issues for each feeder, but will identify feeders on which there is a possibility of steady state voltage concerns for penetrations up to 125% of minimum daytime load.

Table 11: Load and DG Distribution Labels

		Load				
		even	beginning	end	increasing	decreasing
PV Generation	even	a	f	k	p	u
	beginning	b	g	l	q	v
	end	c	h	m	r	w
	increasing	d	i	n	s	x
	decreasing	e	j	o	t	y

Table 11 shows the labels for the different load and DG configurations. Configuration ‘l’ represents a feeder that has all the load located at the end of the feeder with all the DG located at the beginning of the feeder. This configuration is one of the worst cases and can result in the lowest voltage at the end of the feeder. The case with the highest voltage will be configuration ‘h’ in which the DG is located at the end of the circuit, and the load is located at the beginning of the feeder, near the substation.

Figure 3 shown below provides an example of the distribution voltage profile for the Captain Cook 12 feeder. The plot shows that a few load/DG configurations cause steady state voltage problems at a penetration level of 125% daytime minimum load. If the real-life circuit configuration was similar to the “h”, “i”, and “w” configurations, high voltages could occur. It should also be noted that penetration levels below 100% on this circuit did not have any steady state voltage violations.

PSS/E was used to calculate the voltages along the feeders. Circuits that had any voltage outside the limits from 95% to 105% per-unit voltage were flagged. The circuit minimum daily load was used for each of these load/DG configurations. We selected the minimum daily load since the impacts that the DG will have on the circuit voltage will be largest when the load is the

smallest. The transformer tap controls used in the PSS/E database control the low side voltage with no load drop compensation.

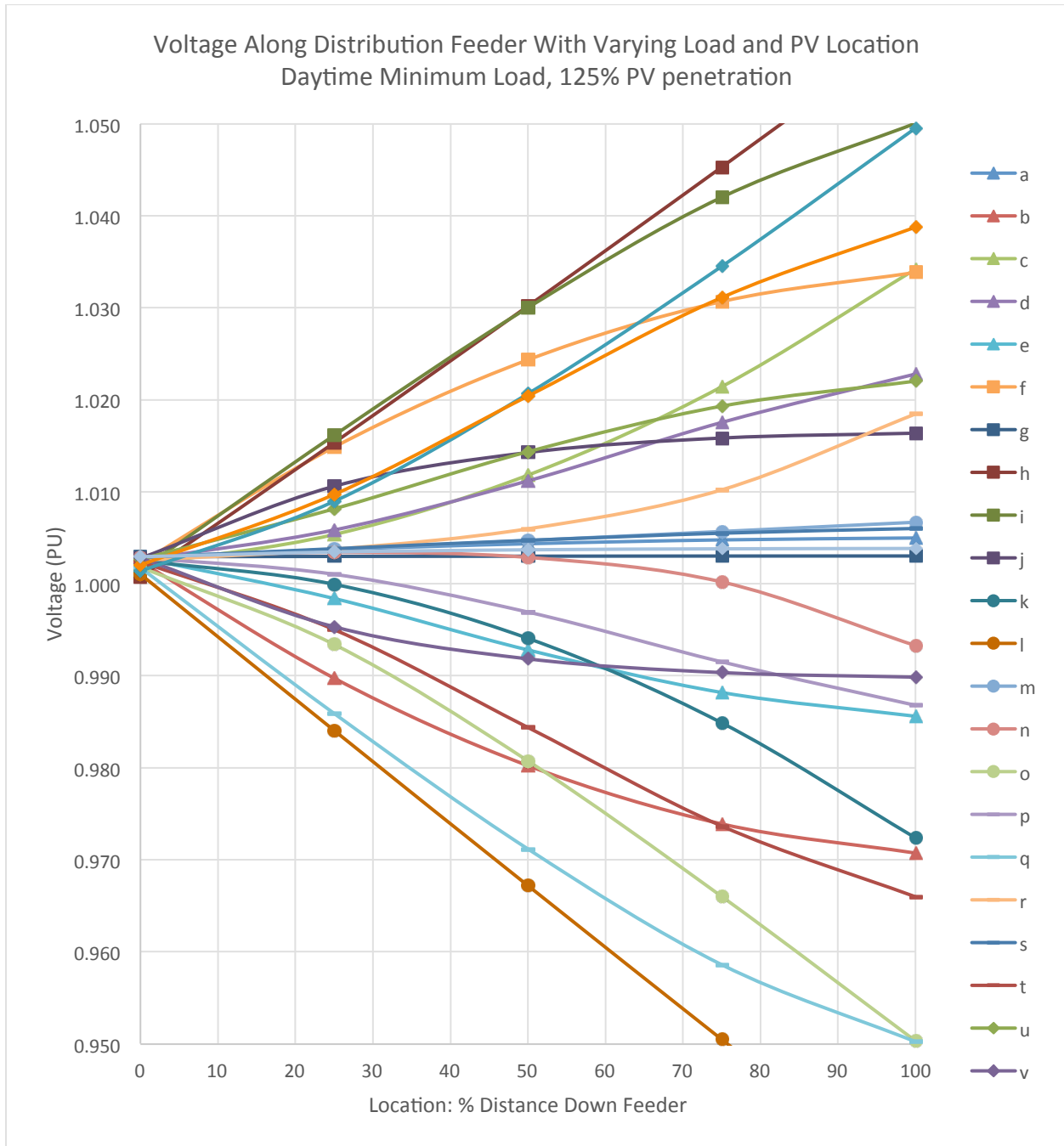

Figure 3: Captain Cook 12 Voltage Profiles

Configuration “o” is used as an example of how to interpret Figure 3. The values on the x-axis represent distance along the feeder as expressed by the percentage of total feeder impedance. A value of 100 represents the voltage at the end of the feeder whereas a value of 0 is located at the substation. Curve “o” has 5 data points at 0, 25, 50, 75, and 100. Each data point represents the per-unit voltage at that location along the distribution feeder. Configuration “o” has all of the

load at the end of the feeder with the DG spread out along the feeder, but decreasing along the length of the feeder. With a penetration of 125%, the voltage at the end of the feeder is approximately 0.95 per-unit, but the voltage at the substation is 1.005 per-unit. These data points are located on the graph at [(100, 0.95) and (0, 1.005)].

Based on the distribution voltage profile analysis, the circuits that could have steady state voltage issues have been flagged. These circuits will require more in-depth analysis to determine the acceptable DG penetration levels using the actual load/DG locations along the feeder. The circuits that were flagged by this analysis are shown in Table 12.

Table 12: Circuits Flagged for Further Distribution Voltage Profile Analysis

Circuit	Max Penetration W/O Voltage Violations
Captain Cook 12	100%
Hakalau 1	100%
Hawi 1	<50%
Kuakini 11	100%
Mauna Lani 13	75%
Ouli 12	75%
Paneawa 11	50%
Papaaloa 1	<50%
Punaluu 11	100%
Volcano 1	<50%
Waikalua 12	100%

The column “Max Penetration W/O Voltage Violations” lists the allowable DG penetration that is allowed with the worst case load/DG configuration. Only circuits that have over-voltage issues were flagged because the DG will serve to increase the voltage along the distribution feeder. It is likely that none of these circuits will have steady-state voltage profile problems, since the voltage problems primarily occur when the DG is at the end of the feeder, and the load is at the beginning of the feeder. Considering that much of the DG will be roof-top installations, the load and DG will more likely be in the same location. This load/DG configuration has a much smaller impact on the circuit voltage profile than when the load and DG are located at opposite ends of the circuit. The results of the steady state distribution voltage profile analysis can be seen in Appendix A.

The additional analysis required would be to determine what type of load distribution along the circuit best fits the actual load configuration. For example, let’s assume that the load along the Captain Cook feeder is fairly evenly distributed along the length of the feeder. Additionally, let’s assume that the DG is primarily roof-top PV, and is also evenly distributed along the feeder. This would correspond to configuration ‘a’ which maintains a reasonable voltage profile along the circuit for every DG penetration level. If, however, the load/DG distribution could cause steady-state voltage concerns, additional voltage control measures are necessary. These control measures could include voltage regulators, switched capacitor banks, and/or active power factor control of the DG, or upgrading the circuit conductor.

4.3.1 Impact of DG Power Factor Control

In general, the addition of DG will increase the voltage on the distribution circuit when compared to the voltage without DG. As seen above over-voltage conditions would be expected with a 125% DG penetration on Captain Cook 12. The following analysis was performed to determine if the DG could control its reactive power output in order to mitigate the high voltages on this

circuit. When the same set of power flow cases were run assuming that the DG was generating at a 0.95 power factor leading, the voltage at the end of the line was reduced. With a penetration level of 125% on Captain Cook 12 the over-voltage was removed when the DG operated at a 0.95 power factor leading. The results of the Captain Cook analysis with a 0.95 power factor are shown below.

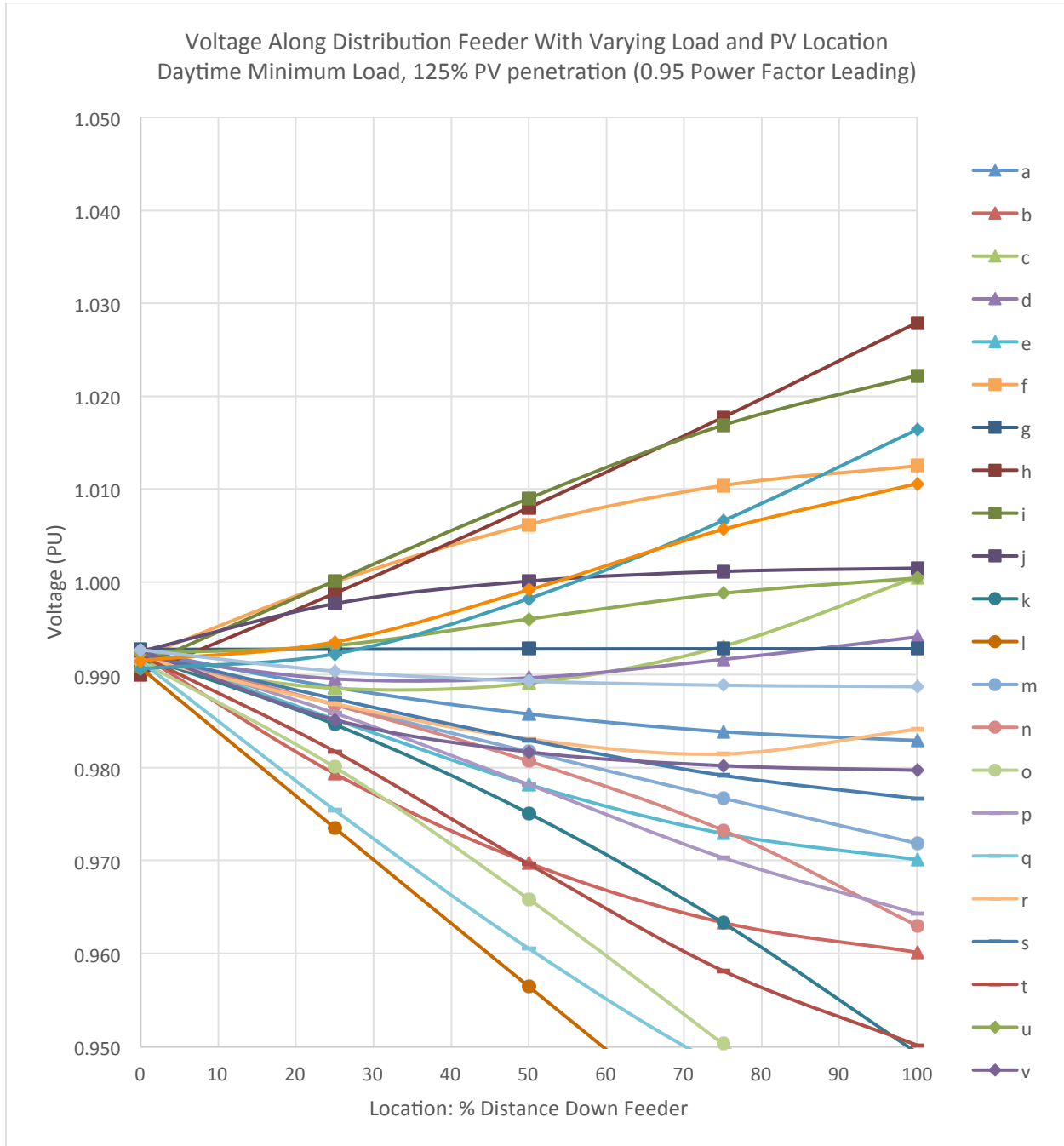

Figure 4: Captain Cook 12 Voltage Profiles With 0.95 Power Factor Leading

As can be seen in Figure 4, the highest voltage along the feeder is less than 1.03 per-unit voltage, with load/DG configuration 'h'. When the DG generated at unity power factor, the voltage was greater than 1.05 per-unit voltage. When the DG connects at a leading power

factor, the configurations with lower voltages are further reduced. It should be noted that the low voltages are approximately the same for all the DG penetration levels because the DG is concentrated near the substation while the load is concentrated at the end of the feeder for the configurations with low voltages.

EPS has studied the impacts that distributed generation has on system voltage. In general, these distributed generation resources will have several impacts on the system. Among these are: impact on distribution voltage profile, impact on frequency of transformer tap-changes, impact on generator power factor, and impact on voltage flicker. Unfortunately, when the distributed generation operates at a specified power factor, it can reduce some of these impacts while making others worse. An example of these conflicts using the Captain Cook 12 feeder is shown and discussed below.

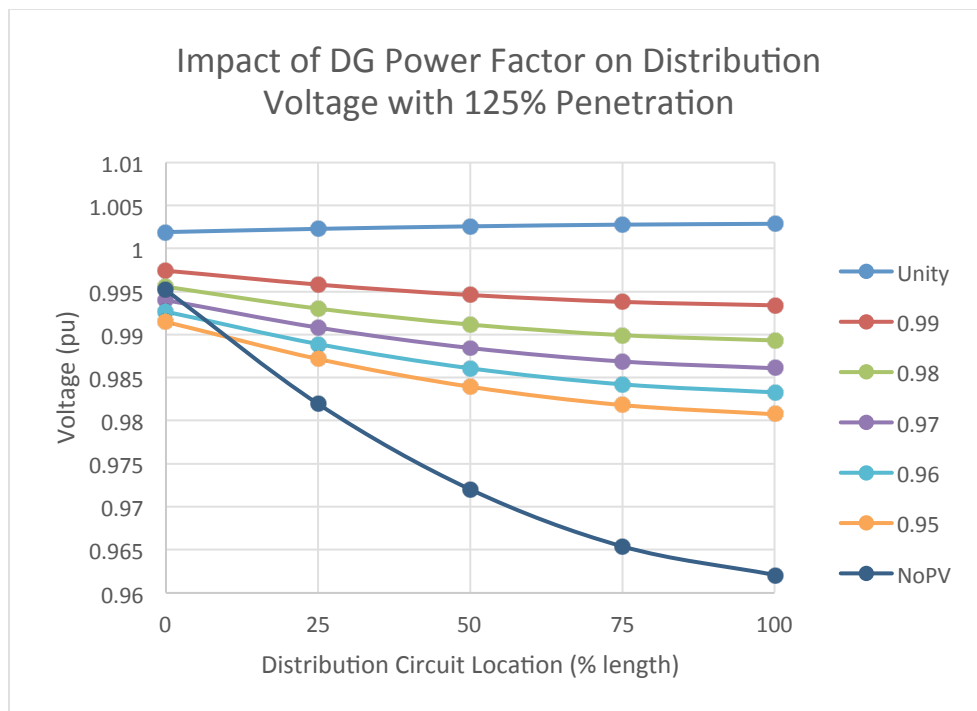

Figure 5: Captain Cook 12 Voltage Profiles vs. DG Power Factor

Figure 5 shows the voltage profile along the Captain Cook 12 feeder when the DG is generating at several different leading power factors. The voltage changes were calculated assuming that the load and DG is evenly spread along the length of the feeder. When the DG power factor is near unity, the voltage along the feeder is nearly constant. A power factor of 0.95 leading would result in the lowest voltage on the feeder, but would still have a higher voltage than if the DG was offline. Unfortunately, the unity power factor, while ideal for the circuit's voltage profile, causes a large voltage change when the solar power output changes. This impact on the distribution voltage at a location due to changes in DG power output is shown below in Figure 6.

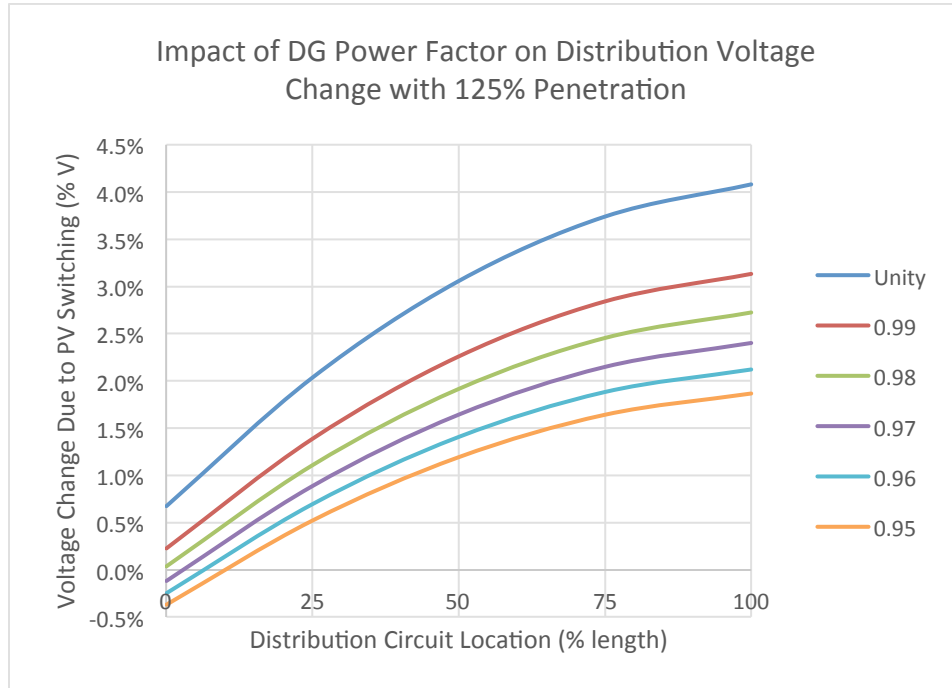

Figure 6: Voltage Change due to DG Cycling

Figure 6 shows the impact on the distribution voltage at locations along the length of the feeder caused by the cycling of DG. For example, with the DG at unity power factor, the change in DG from 0% to 125% penetration level would cause a 4.5% voltage change at the end of the feeder. Depending on how often the solar output changes during the day, this 4.5% voltage change could cause some noticeable voltage flicker (discussed later in this report). The large voltage change could also cause additional transformer tap change operations which could impact the distribution transformer life-expectancy. However, when the DG was generating at a 0.95 leading power factor the voltage change would have been a significantly smaller change in voltage of 1.9%. So, while a unity power factor would provide the best voltage profile along the length of the feeder, it would also cause the largest voltage change due to changes in the DG power output. If the DG were to generate at a lagging power factor instead of leading, the voltage changes would be even larger as the DG varies throughout the day.

The impacts of the DG controlling the reactive power can also have an impact on the system. When the distributed generation is operating at a leading power factor, the conventional generation must increase their VAR output to compensate for the additional system VAR demand. This increase in system VAR demand will increase the system losses (relative to DG operating at unity). The following table shows the impact on the total generation VAR requirements based on DG power factor. Table 13 shows the total MVAR generated by the HELCO conventional generation units when the 165a50 case is altered by setting the DG to the specified leading power factor.

Table 13: System VAR Requirements With Varied DG Power Factor

Power Factor	Total Generated MVAR	Loss Increase (MW)
1	18.14	0.00
0.99	25.87	0.06
0.98	29.15	0.08
0.97	31.74	0.09
0.96	33.97	0.11
0.95	36.03	0.12

When the 50 MW of DG is generating at a 0.95 power factor leading, the HELCO system must provide additional VAR support which will increase system losses. As the amount of distributed generation increases, the demands on the HELCO generation will increase. The additional demands on the conventional HELCO generation fleet are more significant as the penetration increases, and conventional units are cycled. The units will have less capability to provide additional reactive power following contingency events, thereby, placing the system in additional risk.

Table 14: DG Impacts on the Utility Based on DG Power Factor

Issues Caused by DG	Leading (Absorbing VAR)	Unity	Lagging (Generating VAR)
Distribution Voltage Profile		Best	
Voltage Change due to Power Change	Best		Worst
Potential Flicker Issues	Best		Worst
Tap Change Frequency	Best		Worst
System Power Factor	Worst		Best

Table 14 shows the conflicting nature of the DG generating at specified power factors. These are general rules. It is possible that a lagging power factor may be the best option for a certain circuits voltage profile, especially if that circuit is prone to low voltages, but most of the time the leading power factor is best when it comes to the DG's impact on the distribution voltages and resources.

4.4 Voltage Flicker Analysis

Introducing an intermittent load or generation resource to the distributions system can lead to some voltage flicker problems caused by the changing demand or generation. Frequency voltage changes can cause lighting to visibly change light output. IEEE Standard 1543, and other standards lay out limits on the size and frequency of voltage changes that are acceptable on the distribution system. Based on the IEEE 1543 standard, Figure 7 shows the border of lighting irritation caused by voltage flicker on distribution circuits for both the IEEE, and IEC. We have highlighted several points in red callout boxes that will be used in our analysis.

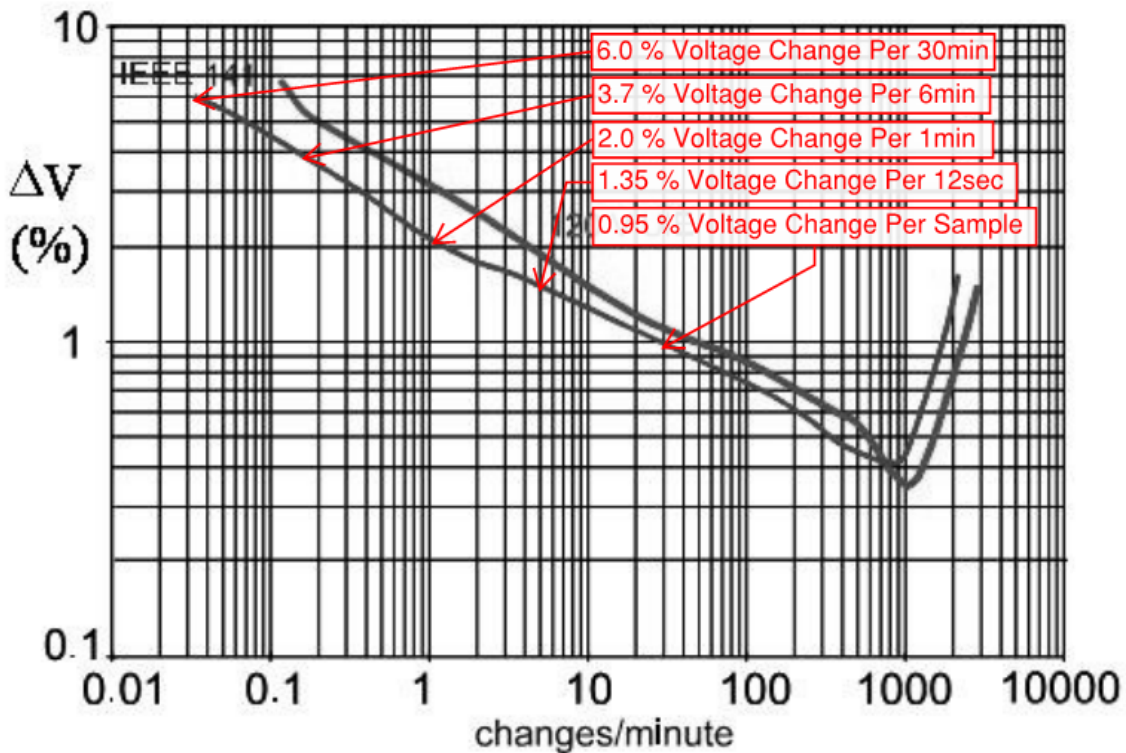

Comparison of IEC 61000-4-15 and IEEE Std 141-1993 for irritation

Figure 7: Voltage Flicker Irritation Limits

As the voltage changes, noticeable illumination changes from lighting equipment can occur. This phenomenon is often referred to as voltage flicker. Figure 7 shows how the frequency and magnitude of voltage changes impact whether these changes in illumination can cause irritation. In order to determine if expected changes in PV generation could cause voltage flicker exceeding these irritability limits, we need to know how fast the PV output changes, and how those changes correlate to a change in voltage.

We analyzed one year's worth of solar data representing the solar output on a Kawaiiani area feeder with a sample rate of 2 seconds (further explanation of the solar data can be found in the Regulation and Ramp Rate Analysis section of this report and Appendix F). Solar power output fluctuations were sorted and counted for several time frames corresponding to the callout boxes in Figure 7 to determine the size of a solar ramp vs. the frequency of the ramp. We selected time frames of 2-seconds, 12-seconds, 1-minute, 6-minute, and 30-minute. A 2-second ramp represents the difference between two consecutive samples. The 12-second ramp would represent the difference between any two samples that are 12 seconds apart. This ramp rate analysis was performed for each sample provided. A plot showing the results of this analysis is shown below.

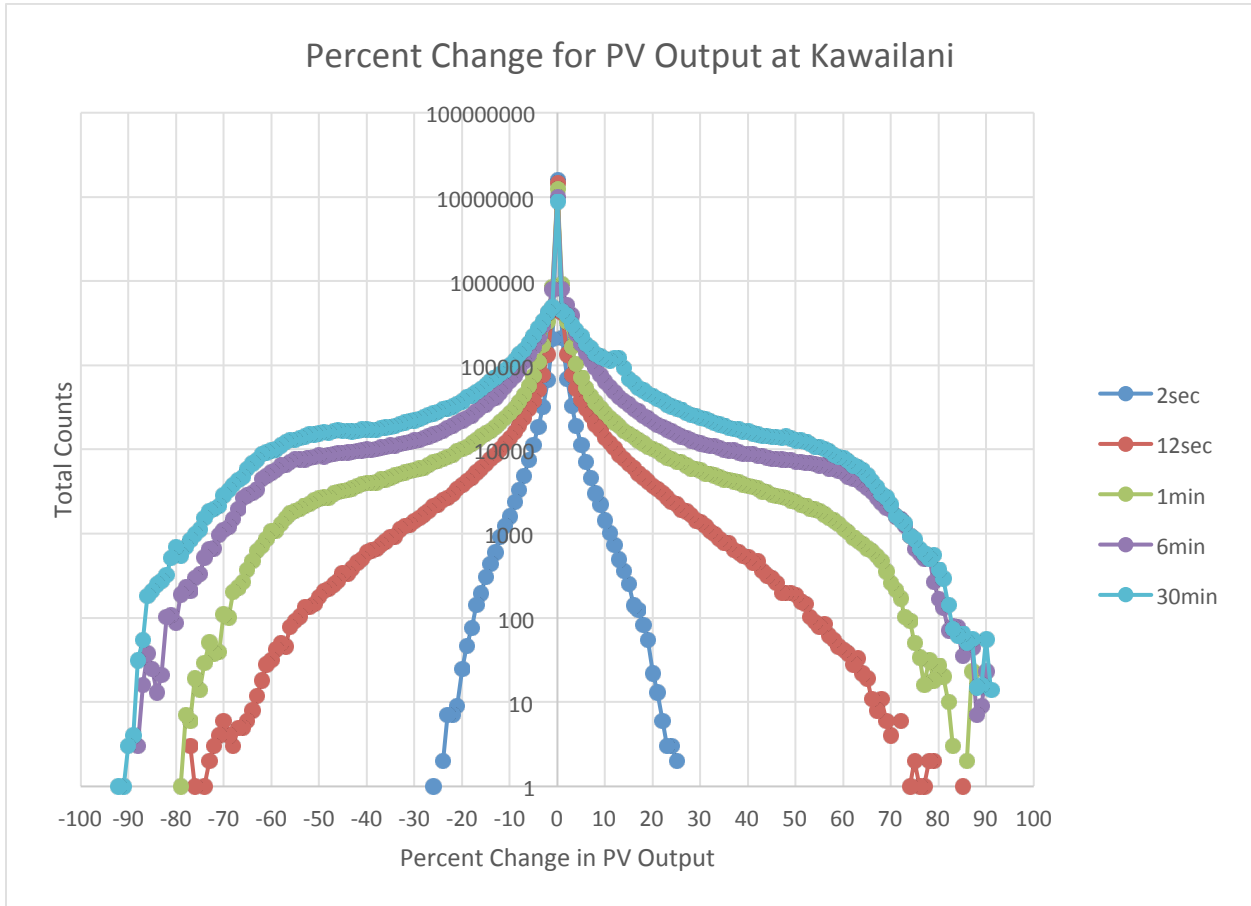

Figure 8: Solar Ramp Counts for 1-year at Kawaiiani

The interpretation of Figure 8 results is best done through an example. The point (25, 2) of the '2sec' curve means that there were two instances during the year when the total solar power output of the circuit increased by 25% of the installed capacity between consecutive 2-second SCADA scans. A ramp of this size is extremely unlikely since there are over 15 million SCADA scans during a year yet only two are 25%. Due to the time constraints dealing with the large amount of data analysis necessary to create this type of plot, the Kawaiiani sensor data was used as the representative circuit output. Kawaiiani was selected since it is on the west side of the island that has historically had more PV installations. The same data is presented in Figure 9 in a manner that is more suitable for use in the voltage flicker analysis.

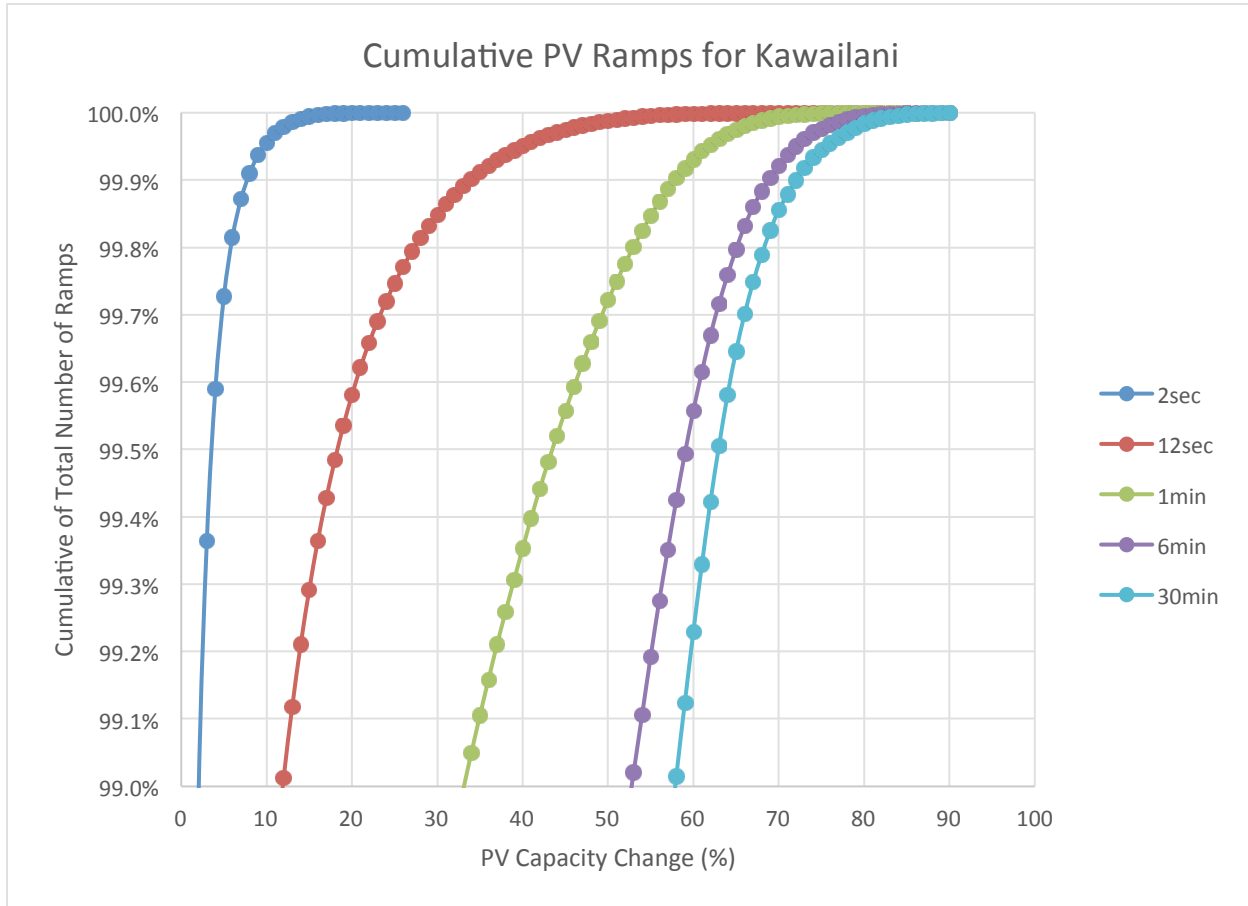

Figure 9: Cumulative PV Ramps for Kawaiilani

Figure 9 shows the percentage of solar ramps that are below a specified capacity change. For example, using the ‘2sec’ data set, the point (4, 99.59%) means that 99.59% of the 2-second ramps have PV capacity changes of 4% or less between samples that are 2 seconds apart.

IEEE 1453 recommends that flicker should be avoided with a 95% probability, and that a 99% probability should be used when performing system planning. Therefore, our task was to confirm that the largest 1% of PV ramps do not cause a large enough voltage change to exceed the limits shown above in Figure 7. When combining the voltage flicker requirements and the actual Kawaiilani PV sensor data, we can statistically determine the amount of PV that could connect to a circuit before voltage flicker becomes a concern.

- Per IEEE 1453 flicker irritability levels shown in Figure 7 an output change that occurs for samples that are 2 seconds apart, the change in voltage should not exceed 0.95%. 99% of the 2 second ramps on the Kawaiilani feeder are less than 2.1% of the installed capacity as seen in Figure 9.
- Per IEEE 1453 an output change that occurs for samples that are 12 seconds apart, the change in voltage should not exceed 1.35%. 99% of the 2 second ramps on the Kawaiilani feeder are less than 11.9% of the installed capacity.
- Per IEEE 1453 an output change that occurs for samples that are 60 seconds apart, the change in voltage should not exceed 2.0%. 99% of the 2 second ramps on the Kawaiilani feeder are less than 33.3% of the installed capacity.

- Per IEEE 1453 an output change that occurs for samples that are 6 minutes apart, the change in voltage should not exceed 3.7%. 99% of the 2 second ramps on the Kawaiiani feeder are less than 52.8% of the installed capacity.
- Per IEEE 1453 an output change that occurs for samples that are 30 minutes apart, the change in voltage should not exceed 6.0%. 99% of the 2 second ramps on the Kawaiiani feeder are less than 57.9% of the installed capacity.

With the solar ramp data and the voltage flicker requirements, we can determine whether the PV can potentially cause voltage flicker violations. We used power flow analysis to determine the change in voltage caused by a change in PV power output. We distributed the PV evenly along the feeder when performing this analysis. Specifically, we assumed that all of the feeder load is located near the distribution substation with the PV spread along the feeder in 25% increments as shown below in Figure 10. This load/PV configuration will result in voltage changes that are fairly extreme. The PV located at the end of the feeder would be the worst case in terms of voltage changes, but is probably not a reasonable load/PV configuration since much of the installed PV is rooftop solar which is located at the load. We assumed that the PV would have an even distribution so that our analysis is on the extreme side of reasonable.

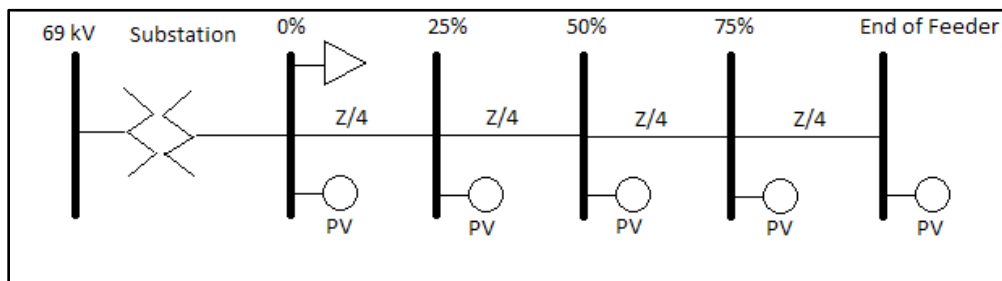

Figure 10: Distribution Analysis One-Line

Using the distribution feeder impedances that were calculated for the distribution voltage analysis, PV was added in 10 kW increments at each PV location until the voltage change caused by the PV was greater than 6%. The voltage at each location along the feeder was recorded and compared against the voltage with 0 kW PV. The PV level that could cause a voltage flicker for each time frame (2-second, 12-second, 1-minute etc.) was recorded. An example showing the results for the Kealia circuit 11 is shown below. The highlighted rows in Table 15 shows the PV power output that the circuit can accept before the change in voltage exceeds the flicker requirements. The results are also summarized in the bulleted list below.

- 0.30 MW changes in generation will be near the acceptable 2-second ramp limit
- 0.45 MW changes in generation will be near the acceptable 12-second ramp limit
- 0.70 MW changes in generation will be near the acceptable 1-minute ramp limit
- 1.35 MW changes in generation will be near the acceptable 6-minute ramp limit
- 2.30 MW changes in generation will be near the acceptable 30-minute ramp limit

Table 15: Kealia 11 Change in Voltage Due to Change in PV Output

Total PV (MW)	V at Sub	V at 25%	V at 50%	V at 75%	V at 100%	Change in V (%)	
0.00	1.0478	1.0481	1.0483	1.0484	1.0485	0.00%	
0.05	1.0480	1.0488	1.0494	1.0498	1.0499	0.15%	
0.10	1.0483	1.0496	1.0505	1.0511	1.0514	0.29%	
0.15	1.0486	1.0503	1.0516	1.0524	1.0528	0.43%	
0.20	1.0488	1.0510	1.0526	1.0537	1.0542	0.58%	
0.25	1.0491	1.0517	1.0537	1.0550	1.0557	0.72%	
0.30	1.0493	1.0524	1.0548	1.0563	1.0571	0.86%	
0.35	1.0496	1.0532	1.0559	1.0576	1.0585	1.00%	0.95% Limit
0.40	1.0498	1.0539	1.0569	1.0589	1.0599	1.14%	
0.45	1.0501	1.0546	1.0580	1.0602	1.0613	1.28%	
0.50	1.0503	1.0553	1.0590	1.0615	1.0627	1.42%	1.35% Limit
0.55	1.0505	1.0560	1.0600	1.0627	1.0641	1.56%	
0.60	1.0508	1.0566	1.0611	1.0640	1.0655	1.70%	
0.65	1.0510	1.0573	1.0621	1.0653	1.0668	1.84%	
0.70	1.0512	1.0580	1.0631	1.0665	1.0682	1.97%	
0.75	1.0515	1.0587	1.0641	1.0677	1.0695	2.11%	2.1% Limit
0.80	1.0517	1.0593	1.0651	1.0690	1.0709	2.24%	
0.85	1.0519	1.0600	1.0661	1.0702	1.0722	2.38%	
0.90	1.0521	1.0607	1.0671	1.0714	1.0736	2.51%	
0.95	1.0523	1.0613	1.0681	1.0726	1.0749	2.64%	
1.00	1.0526	1.0620	1.0691	1.0738	1.0762	2.77%	
1.05	1.0528	1.0626	1.0701	1.0750	1.0775	2.91%	
1.10	1.0530	1.0632	1.0710	1.0762	1.0788	3.04%	
1.15	1.0532	1.0639	1.0720	1.0774	1.0801	3.17%	
1.20	1.0534	1.0645	1.0729	1.0786	1.0814	3.30%	
1.25	1.0536	1.0651	1.0739	1.0798	1.0827	3.42%	
1.30	1.0538	1.0658	1.0748	1.0809	1.0840	3.55%	
1.35	1.0540	1.0664	1.0758	1.0821	1.0853	3.68%	
1.40	1.0542	1.0670	1.0767	1.0833	1.0865	3.81%	3.7% Limit
1.45	1.0544	1.0676	1.0777	1.0844	1.0878	3.93%	
1.50	1.0546	1.0682	1.0786	1.0856	1.0890	4.06%	
1.55	1.0548	1.0688	1.0795	1.0867	1.0903	4.18%	
1.60	1.0549	1.0694	1.0804	1.0878	1.0915	4.31%	
1.65	1.0551	1.0700	1.0813	1.0890	1.0928	4.43%	
1.70	1.0553	1.0706	1.0822	1.0901	1.0940	4.55%	
1.75	1.0555	1.0712	1.0831	1.0912	1.0952	4.68%	
1.80	1.0557	1.0718	1.0840	1.0923	1.0964	4.80%	
1.85	1.0558	1.0723	1.0849	1.0934	1.0976	4.92%	
1.90	1.0560	1.0729	1.0858	1.0945	1.0989	5.04%	
1.95	1.0562	1.0735	1.0867	1.0956	1.1001	5.16%	
2.00	1.0563	1.0740	1.0876	1.0967	1.1012	5.28%	
2.05	1.0565	1.0746	1.0884	1.0978	1.1024	5.40%	
2.10	1.0567	1.0751	1.0893	1.0988	1.1036	5.52%	
2.15	1.0568	1.0757	1.0901	1.0999	1.1048	5.63%	
2.20	1.0570	1.0762	1.0910	1.1010	1.1060	5.75%	
2.25	1.0572	1.0768	1.0918	1.1020	1.1071	5.87%	
2.30	1.0573	1.0773	1.0927	1.1031	1.1083	5.98%	
2.35	1.0575	1.0779	1.0935	1.1041	1.1094	6.10%	6.0% Limit

Kealia circuit 11 has a minimum daytime load of 0.39 MW. The 2-second flicker threshold is 0.95% voltage change. The PV generation doesn't exceed the 0.95% voltage change until the PV generation is increased above 0.3 MW. Based on our ramp analysis, 99% of the PV ramps are less than 2.1% of the total PV capacity. Therefore, in order to be within the flicker

requirements the total PV capacity should be less than 14.29 MW (0.3/0.021). An example showing the results of the flicker analysis for the Kealia 11 circuit is shown below in Table 16.

Table 16: Voltage Flicker Maximum Allowable Capacity on Kealia 11

Time Frame	PV MW	Ramp Threshold	PV Max Capacity (MW)
2-sec	0.30	2.10%	14.29
12-sec	0.45	11.90%	3.78
1-min	0.70	33.30%	2.10
6-min	1.35	52.80%	2.56
30-min	2.30	57.90%	3.97

In this case, the limiting case based on flicker is the 1-minute ramp which has a maximum PV capacity of 2.1 MW. Considering the Kealia 11 circuit has a daytime minimum load (DML) of 0.39 MW, the 2.1 MW required to violate the voltage flicker criterion would correspond to a penetration greater than 500% of DML.

This analysis was performed for each circuit for which we received the necessary drawings. Based on this analysis, only the following circuits could exceed the voltage flicker levels for PV penetrations up to 125% of DML.

- Hawi 1
- Huehue 11
- Volcano 1

The circuits listed above were all highlighted as circuits that have steady state voltage problems in the distribution voltage profile analysis section above. These issues are due to the high impedance of the circuit, not necessarily the amount of PV on the circuit. Based on the significant voltage problems on these circuits, it is likely that a large portion of the load on these circuits is near the substation. When PV generation is located near the substation it will have less voltage change on the circuit, and therefore, will be less likely to violate the voltage flicker criteria. The results of the flicker analysis is attached in Appendix B.

4.5 Steady State Conclusions and Recommendations

The steady state contingency analysis had neither overloaded lines, nor voltages outside their limits. In general, the addition of distributed generation will serve to reduce the line overload issues by reducing the overall system loading. The distributed generation also decreased the voltage angle across open breakers on the HELCO system.

Based on distribution voltage profile, several distribution circuits may be susceptible to steady-state voltage problems with some potential PV/load configurations. Additional analysis of these circuits is recommended to better quantify the location of the load and PV generation along the length of the circuit. Once the location of the load and PV generation has been determined, the best fit voltage profile can be used to determine if the circuit is actually susceptible to steady-state voltage issues.

If the PV generation has the capability to adjust its reactive power output, the voltage issues seen in the distribution voltage profile analysis could be resolved. However, when the PV changes its power factor, there are several conflicting system issues. The proper voltage control scheme has a lot to do with the location of the PV resources along the length of the distribution line. When the PV is located near the distribution substation, unity or lagging power factor may be preferable from a system-wide perspective. However, when the PV is located near the end of

a longer distribution circuit, the PV should be generating at unity or a leading power factor to reduce the negative voltage impacts like flicker, and voltage regulation on the distribution circuit.

In general, the chances of the PV generation causing large enough voltage changes to violate the voltage flicker criteria recommended in IEEE 1453 is low. Our analysis did highlight a few circuits on which voltage flicker violations are possible. HELCO should analyze these circuits more closely to determine if voltage flicker violations are indeed possible using the actual load and PV distribution along the length of the feeder. Table 17 shows the circuits that warrant additional analysis to review the steady state voltage concerns with penetrations up to 125% of the minimum daytime load.

Table 17: Steady State Circuit Concerns

Circuit	Max Penetration W/O Voltage Violations	Flicker Possible
Captain Cook 12	100%	
Hakalau 1	100%	
Hawi 1	<50%	Yes
Kuakini 11	100%	
Mauna Lani 13	75%	
Ouli 12	75%	
Paneawa 11	50%	
Papaaloa 1	<50%	
Punaluu 11	100%	
Volcano 1	<50%	Yes
Huehue 11	>125%	Yes
Waikaloa 12	100%	

5 Transient Stability Analysis

In order to determine the impact the distributed PV generation has on the HELCO system in the transient stability time frame, EPS performed transmission line fault and trip simulations. These simulations assumed primary protection clearing times, and fault locations at each side of all the major HELCO transmission lines. These simulations were run for each of the power flow cases created for this project. In addition, EPS also performed several large unit trip scenarios for each power flow case.

5.1 Unit Trip Simulation Results

EPS configured the unit trip simulations to trip a unit breaker at a simulation time of one second. The unit trip simulation was run for each power flow case with each major generating unit. Each simulation result had a stable system frequency, voltages were within limits, and units remained in synchronism. Table 18 shows the cases that resulted with load being shed, and are color coded based on the number of stages of load that were shed. Cells with a white background represent cases that tripped one stage of load shed while the highlighted cases show the cases that shed two stages.

Table 18: Load Shed Results for Unit Trips

Apollo	HEP1	HEP2	HuHonua	Kano H6	Keah CT4	Keah CT5
155c30	145b	155d	155b	145b30	145b	165a
155c40	145d	165a	145b30	165b30	155b	155a30
165c40	155b	175a	145d30	165b40	155c	165a30
175d50	155c	155a30	155c30	145dmax	165a	145a40
	165a	165a30	155d30	145emax	145b30	155a40
	175d	145a40	165a30		155c30	165a40
	145d30	155a40	165b30		155d30	175a40
	155a30	165a40	145a40		165b30	145a50
	155d30	175a40	155a40		175b30	155a50
	165a30	145a50	155c40		155b40	
	165d30	155a50	165b40		165b40	
	175b30	175a50	165c40		165c40	
	175d30	145bmax	165d40		165d40	
	155d40		175a40		165b50	
	165a40		145a50		175d50	
	165d40		155a50		145bmax	
	175a40		165b50		145cmax	
	165d50		175d50		145fmax	
	175d50		145amax			
			145emax			
			145fmax			

The amount of PV generation did have an impact on the number of stages of load shed. Only one case simulation with 30 MW of PV generation tripped stage 2 (HEP2 – 155a30), but as PV increased, more simulations needed the second stage to arrest system frequency decay. This is partially due to the amount of “net” load shed with each feeder. The distributed generation on the feeders designated in the under-frequency load shed scheme will directly offset some of the benefit of tripping the feeder to arrest the frequency decay. As the PV penetration on a feeder increases, the effective “net” load decreases. When the PV penetration exceeds 100%, tripping the feeder in the UFLS scheme will be detrimental to the system frequency response.

Table 18 shows that some of the cases with PV online shed 2 stages, but when PV is offline, only stage 1 of load shedding is necessary to arrest the frequency decay. There are two reasons why the cases with PV online result in more stages of load shed. First, some of the older PV installations have a frequency trip setting of 59.3 Hz. These installations will trip on under-frequency protection, thereby exacerbating the original trip event. EPS understands that newer installations are meant to ride through the 59.3 Hz and are not required to trip until 57.0 Hz. However, HELCO should monitor system events to more accurately assess the ability of the new installations to ride-thru to 57.0 Hz. Any additional PV that will trip at 59.3 Hz will worsen the system frequency response to unit trip events and will require more load shedding in order to arrest the system frequency decay. Second, the distributed nature of the PV generation will reduce the net load of the tripped feeders. Therefore, the cases with PV generation will need to trip more feeders (customers) to get the same amount of “net” load tripped for the same precipitating event. This has a negative impact on the system outage and reliability statistics.

The reduced effectiveness of the UFLS scheme due to the increase in PV generation should be addressed by HELCO to maintain system stability. HELCO should review the UFLS system to ensure that each stage of the UFLS system has the correct amount of “net” load. It is also important to periodically reevaluate the UFLS system as the amount of distributed generation is rapidly increasing on the island. HELCO could also consider a solution that automatically assigns feeders to the UFLS scheme based on the real-time measurements of “net” load. This way, the system could adjust the UFLS scheme to reflect the significant feeder loading differences between day and night. Additionally, a UFLS blocking scheme should be enacted to prevent feeders with high PV penetration that are back-feeding into the HELCO system from tripping on under-frequency protection.

With large amounts of Rule 14H compliant PV, the system is very sensitive to an overshed condition, that is where the UFLS system sheds more load than is required and the system frequency exceeds 60.5 Hz. With high penetration levels and an over shed condition by the UFLS system, if frequency exceeds 60.5 Hz, all Rule 14H compliant PV will trip off-line, resulting in a probable system collapse.

5.2 Line Fault and Trip Results

5.2.1 Normally Cleared Faults

Various line fault and trip events were simulated on the HELCO system. Primary clearing times were in the range from 4 to 7 cycles. EPS ran these fault simulations for each transmission line for each of the power flow cases created for this study.

Each fault and trip scenario resulted in a stable system. Both the voltage and frequency returned within normal range after the event was finished. No fault and trip scenario resulted in any under-frequency load shed. No unit lost synchronism. This would indicate that all faults were below the critical clearing time of the system. The results for one event are shown below in Figure 11.

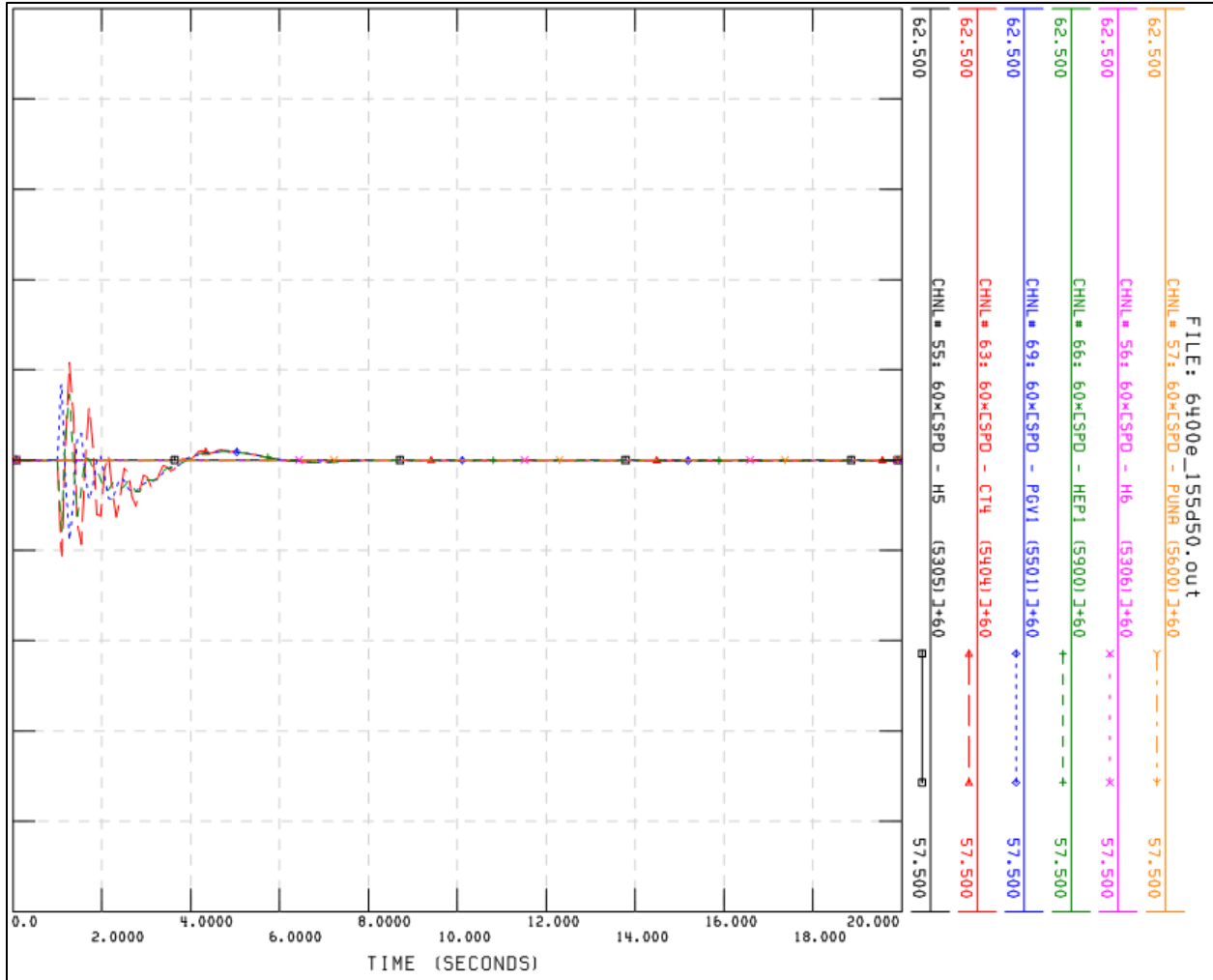

Figure 11: Unit Speed Recordings, Normally Cleared Fault on Line 6400, Case 155d50

Figure 11 shows the system frequency response for a normally cleared fault on line 6400. The vertical scale has a minimum of 57.5 Hz, and a maximum of 62.5 Hz with gridlines for each 0.5 Hz. This line has no substations taps, and after the line is tripped there is no major loss of load. Therefore, the system frequency returns to near 60 Hz.

Since each transmission line was tripped while studying these line faults, the impact of the loss of load was studied. The line with the largest loss of load was the 7500 line. The system wide impact this loss of load is minimal. The system frequency increases by anywhere from 0.1 Hz to 0.2 Hz based on the dispatch scenario, but does not approach the 60.5 Hz PV trip threshold. The loss of line 7500 with a system load level of 175 MW is shown below in Figure 12.

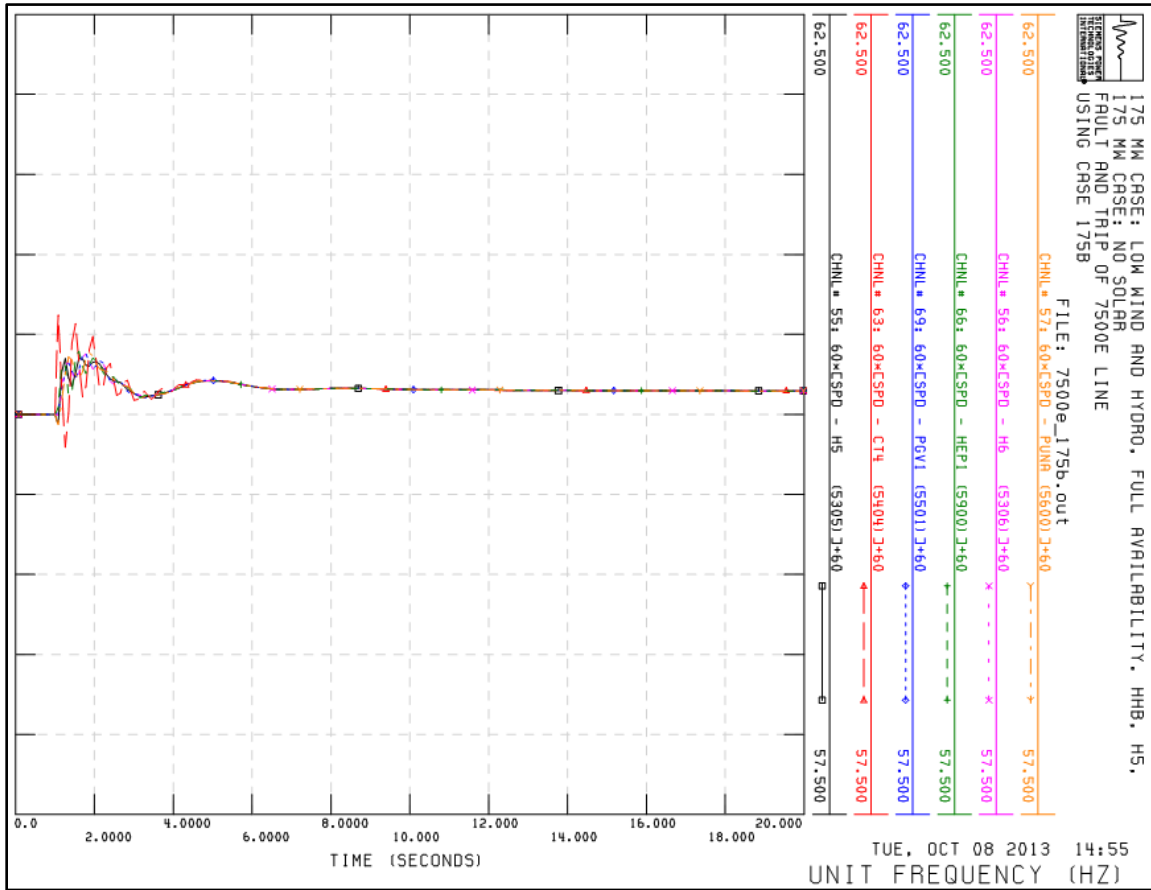

Figure 12: Loss of Line 7500

Figure 12 shows the system frequency response for the loss of the 7500 line on a scale from 57.5 to 62.5 Hz. As the level of DG on the 7500 line increases, the total loss of load for this contingency decreases, and will have even less impact on the system. The transient stability traces for the unit trip simulations and the normally cleared transmission fault simulations are attached in Appendix C.

5.2.2 Critical Clearing Time Analysis

Critical clearing time is defined as the longest amount of time a fault can remain on the system such that when cleared, the system returns to a stable condition. Faults beyond that time result in an unstable system resulting in the loss of load and generation as well as the potential for major equipment damage and system collapse.

Prior to the rapid rise of Rule 14H compliant PV, primarily roof-top PV, the HELCO system was fairly robust. Transmission lines employ communications assisted relaying, resulting in fast clearing times and minimum fault durations. The system has some lines that utilize the county microwave system for protective relaying communications. This communications system is a lower reliability than typical protective relaying communications. For faults on the these lines, the HELCO system could withstand fault durations of at least 22 cycles without any impacts to system stability, loss of generation or loss of load. With the exception of a few abnormal generation dispatch cases, the HELCO system could withstand a 22 cycle fault on all of its remaining transmission lines with more reliable communication circuits.

For all generation scenarios, the system could withstand fault durations of 15-cycles on any transmission line, allowing adequate time for breaker-fail and stuck breaker relaying.

Since the system was stable without the consideration of the Rule 14H compliant PV, EPS ran simulations for fault conditions that are only 1 cycle greater than the PV under voltage tripping required in Rule 14H. These simulations were run to determine the impact that the current trip requirements of the IEEE 1547/Rule 14H standard have on the HELCO system. The modification to Rule 14H has changed the must-trip requirement from 59.3 Hz to 57.0 Hz. However, this standard requires the generation to have tripped off-line by the time frequency reaches 57.0 Hz. It does not require the generation to remain on-line until the frequency reaches 57.0 Hz. This study assumes all Rule 14H generation added after the modification to Rule 14H remains on-line until 57.0 Hz. The modification to Rule 14H does not address the significant problems related to the under-voltage or over-frequency trip requirements. The IEEE 1547/Rule 14H standard requires that the DG cease to energize (trip off-line) in 10 cycles or less if the voltage drops below 50% or if the frequency rises above 60.5 Hz. In addition, the DG must cease to energize in two seconds or less if the voltage is between 50% and 88% of nominal. The clearing time specified in the standard is the time between the start of the abnormal condition and generation ceasing to energize. This means that the time for the generation to cease generating must be considered when determining the critical clearing time from the transmission system's perspective, and will vary by inverter manufacturer. These simulations were intentionally set up to force all the DG on the HELCO system that is subject to voltages below 50% to trip offline.

The line faults with clearing times greater than 10 cycles had severe impacts on the HELCO system for many different line faults. Almost all simulations were stable, but the events were very severe and bring the system near the stability limits and in actual practice may result in system collapse. For instance, the simulation mathematically determines the voltage and frequency at each bus during the fault, if the voltage returns to a point only a few volts above its trip point or if the duration is only ¼ cycle less than the trip point, the simulation will not trip the PV. However, in actual practice, the tolerance level of the PV controls may exhibit more trips than indicated by the simulation. The general description of these extended fault scenarios is as follows:

1. The transmission line fault is applied
2. After the fault has been active for 10 cycles, the DG in locations that have voltage below 50% will have ceased energizing the system, resulting in a load/generation mismatch
3. For locations that do not see voltages below 50%, the over-frequency protection may activate if the localized frequency exceeds 60.5 Hz for 10 cycles
4. The fault clears after 11 cycles
5. The frequency decays due to the load/generation mismatch
6. At a frequency of 59.3 Hz, the older DG trips on under-frequency protection
7. Load is tripped as part of the UFLS scheme
8. Frequency recovers
9. For some of the maximum penetration cases, the last stage of load shed is large enough to cause an over-frequency event
10. The Tawhiri plant and/or remaining DG may trip offline due to over-frequency protection

Figure 13 shows an example of a typical result with delayed clearing of a three phase fault.

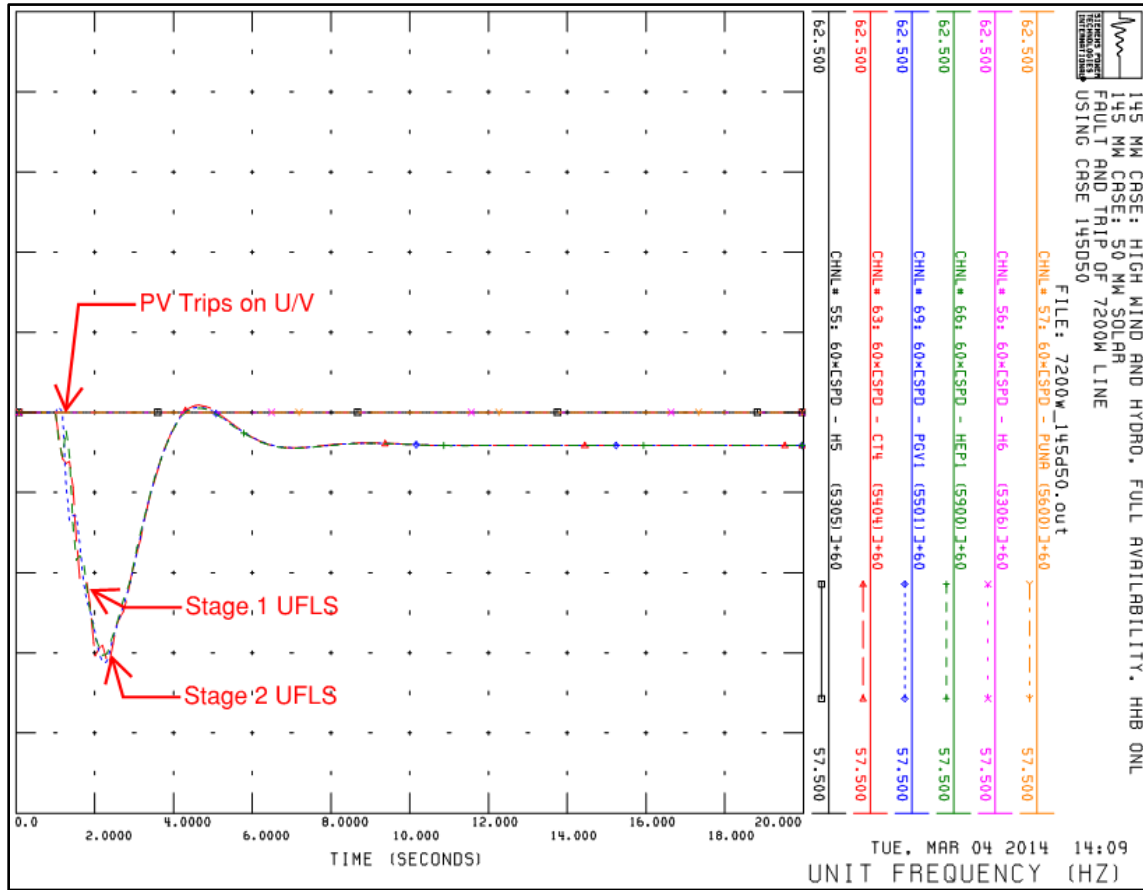

Figure 13: Unit Speed Recordings for 11-Cycle Fault on Line 7200, Case 145d50

Figure 13 shows the system frequency response to a fault near the Keamuku bus. The Waimea breaker opened at 5 cycles, and the Keamuku breaker opens after about 11 cycles. As described above, the fault causes some of the DG to trip on under-voltage protection. The load/generation mismatch causes a frequency decay that load shedding arrests at ~58.5 Hz. The vertical scale goes from 57.5 to 62.5 Hz with gridlines every 0.5 Hz. The horizontal scale shows the time from 0 to 20 seconds with gridlines every 2 seconds. This case has 50 MW of DG online at the time of the fault.

The design zone 1 clearing times on the HELCO system are all less than 10 cycles, however, with the increase in PV the margins can be very tight. Since the PV generation must cease energizing the system within 10 cycles, the decision to cease energizing the PV system must occur early enough to allow the inverter to cease energizing. Assuming that the inverters need 1 cycle to go from full load to zero, this leaves 9 cycles for the fault to clear before the PV will cease energizing. HELCO does have some older, oil circuit breakers that have designed clearing times of 5 cycles. Assuming that the relay decision time is approximately 2 cycles, and communications for the POTT scheme takes another cycle, the breaker would clear the fault in 8 cycles. Considering the voltage recovery after the fault is not instantaneous, the 1 cycle margin between the time for primary protection to clear the fault, and the time for the PV inverters to decide to de-energize is quite small. Upgrading all transmission breakers to 3-cycle breakers would significantly reduce the chance for the 1547 under-voltage protection requirements to be seen for normally cleared transmission faults.

Due to the severe nature of these extended clearing times, the chances of communication failure of the POTT scheme should be minimized. We recommend that HELCO assess the communication scheme, and upgrade the communications where possible to minimize the risk of a communication failure.

In general, DG levels below 40 MW on the HELCO system are unlikely to cause load shedding for three phase faults with delayed clearing. Only select lines would cause the system to require load shedding to arrest system frequency decay. However, once the system-wide DG exceeds 40 MW, the line faults that can cause the system to need load shedding to arrest the system frequency decay are widespread. Table 19 below shows the load shedding results for 11-cycle faults using the 155 MW scenario 'd' cases. The full list of delayed clearing events that caused load shedding is included in Appendix D. The blue highlighted cell represents that the case required stage 2 to be shed. The faulted line 'e' or 'w' specifies where the fault is located. The 'e'/'w' was arbitrarily selected for north/south running lines.

Table 19: UFLS Stages Shed Due to Delayed Fault Clearing

Case	155d30	155d40		155d50	
F a u l t e d L i n e s	6700w	6100w	7700w	6100w	7700w
	9200w	6200e	7800e	6200e	7800e
	9300w	6200w	8100e	6200w	8100e
		6700e	8200w	6500e	8100w
		6700w	8500e	6700e	8200w
		7200w	8500w	6700w	8400e
		7400e	9200w	6800e	8400w
		7400w	9300e	6800w	8500e
		7600e	9300w	7100e	8500w
				7200w	9100e
				7300e	9200w
				7400e	9300e
				7400w	9300w
				7500w	9500w
				7600e	

In the maximum DG penetration cases many faults result in four stages of load shedding, and the potential for an over-frequency event and associated Tawhiri plant trip. Additionally, the rate of frequency decay during these events is large and may cause some issues related to the over-temperature tripping protection of the combustion turbines on the HELCO system. An example is shown below in Figure 14.

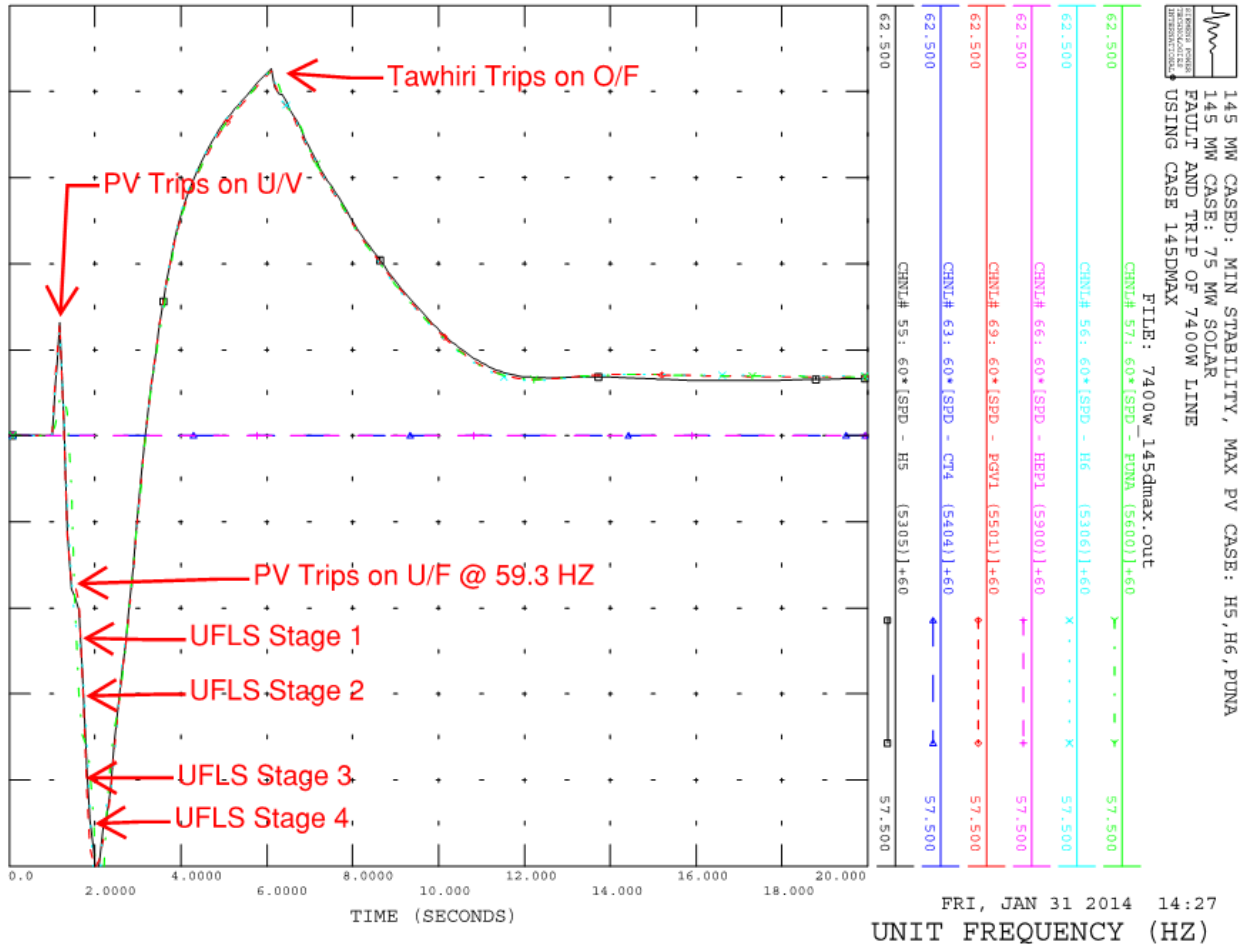

Figure 14: Unit Speed Recordings for 11-Cycle Fault on Line 7400, Case 145dmax

Figure 14 shows one of the most severe simulations that resulted in four stages of load shed being tripped, and the resultant over-frequency event that tripped the Tawhiri plant.

Again, these simulations were run assuming a relaying communications failure or a slow breaker. Due to this assumption, these simulations are closer related to an N-1-1 contingency which is not within the scope of the HELCO transmission planning criteria which only specifies primary protection times. Therefore, these simulations were run to inform HELCO that these events are possible, and that significant consequences that could come from a primary protection failure or slow breaker times.

Every IPP contract since the late 1990's on the HELCO system has had language requiring ride-through capabilities for secondary fault clearing times, including contracts for HRD wind, Tawhiri wind, PGV, Hu Honua, and HEP. It is standard practice at HELCO to design the ride-through requirements for IPP connections based on riding through zone 2 clearing such that the generation remains connected to the system. The aggregate effect of the distributed generation is in violation of this historical IPP generation requirement. A must-trip requirement, as used in the IEEE 1547 standard, would be unacceptable for transmission connected generation. EPS recommends that HELCO immediately review and change the required trip settings for new distributed generation connections. Also, HELCO should review if retrofitting the existing DG to extend the voltage and frequency ride through settings is possible. The transient stability plots showing the results of the delayed clearing line faults is attached in Appendix E.

The delayed clearing simulations showed that the DG would primarily trip due to under-voltage protection. If HELCO were to require that all new DG connections must ride through these delayed clearing events, it is possible for the over-frequency protection to trip the inverter systems. A fault on the HELCO transmission system will cause the conventional generation to speed up. If the DG does not trip on under-voltage, this increased speed may cause a system frequency above a 60.5 Hz. Therefore, we recommend that both the under-voltage and over-frequency trip settings be revised to prevent tripping for these faults with delayed clearing.

5.3 Energy Storage Sensitivity Cases

Several sensitivity cases were created to test the benefits that an energy storage system could provide in response to transient stability contingency events. The energy storage system was added to the HELCO system and modeled as a 10 MW battery system connected to the Keamuku substation via a 69/0.69 kV transformer with a 7% impedance. The battery was configured to respond to frequency changes via droop control. The droop setting was configured such that the battery would provide the rated 10 MW at a frequency of 58.8 Hz (the frequency at which stage 1 is triggered). The battery was configured to have a 0.1 Hz deadband around 60 Hz.

Several simulations were selected to show the benefit to the HELCO system when a battery was added. The simulations were a fault and trip of the 6700 (Kahaluu – Keahole), 7800 (Kanoelehua – Puueo), and 6200 (Kaumana – Keamuku) transmission lines with delayed clearing (>10 cycles). A trip of the HEP 2 combustion turbine was also run. Table 20 shows the impact that the Battery Energy Storage System (BESS) system has on the amount of load shed for these events.

Table 20: BESS Sensitivity Case Results

Outage	Case	No Bess	Bess
6700w	165a30	1	0
	165a40	1	0
	165a50	1	1
7800e	155b30	2	2
	155b40	2	2
	155b50	2	2
6200e	145amax	4	3
	145bmax	3	3
	145cmax	4	4
	145dmax	4	4
	145emax	4	3
	145fmax	4	4
HEP2	145a30	0	0
	145a40	2	1
	145bmax	2	0

The “Outage” column shows the simulated outage. The case column lists the dispatch case that was used for the simulation. The “No Bess” and “Bess” columns show the total number of under-frequency load shedding stages that tripped during the simulation without and with the BESS installed. The battery system would provide a significant benefit for unit trip simulations, as seen in the bottom two rows that show the BESS could possibly prevent two stages of load shedding for a trip of the HEP 2 combustion turbine.

Unfortunately, while the BESS system could provide significant system benefit when responding to frequency excursions, it does little to help HELCO in response to line faults with extended

clearing time. The long clearing times for line faults on the system cause the under-voltage protection of the DG to trigger, and trip the DG, thereby creating a generation mismatch, and requiring UFLS to operate. The battery can provide some benefit after the fault has cleared by providing some real power support, but provides little/no benefit during the fault. This is primarily due to the fact that the inverter based battery system provides limited current during the fault and does little to “prop-up” the system voltage and prevent the DG tripping. If the under voltage trip settings were revised so that the PV would ride through typical fault scenarios, then the battery would provide significant system benefit by preventing the loss of PV due to frequency events.

5.4 Transient Stability Results and Conclusions

The increase of photovoltaic generation on the HELCO system can have many negative impacts on the transient stability of the system. The major impacts include:

- Under Frequency Load Shedding
 - More circuits must be shed in order to trip the same desired power as DG penetration increases. This has a direct impact on the system reliability statistics.
 - DG tripping at a frequency of 59.3 Hz worsens under-frequency events.
- Delays in the clearing of faults can have significant system impacts.
 - DG can trip for an under-voltage condition of less than 50% voltage for 10 cycles.
 - DG can trip for an over-frequency condition when frequency is above 60.5 Hz for 10 cycles.
 - As DG on the HELCO system increases, the impacts of this nuisance tripping will become more severe, and could cause system wide instability.
 - As DG increases, the contingency with the single largest loss of generation could be caused by a line fault with delayed clearing.
- Energy storage can provide benefit to the system, but has little/no impact on the issues seen with delayed clearing of transmission faults.

Due to these concerns EPS has the following recommendations:

- The UFLS system should be adjusted to ensure that feeders that are backfeeding are not shed as part of the UFLS system.
- HELCO should investigate the possibility of an active UFLS scheme which can automatically, in real time, adjust which feeders are on the different UFLS stages. This would be to ensure that the MW shed in each stage of UFLS correspond to the UFLS design.
- HELCO should upgrade all transmission breakers to have 3-cycle clearing times.
- HELCO should evaluate and upgrade the communication circuits of the protection scheme to mitigate the risk of communication failure.
- HELCO should review and change the voltage and frequency trip settings for new DG interconnections on the system.
- HELCO should pursue retrofitting the existing DG interconnections to lengthen the voltage and frequency ride-through capabilities.

- If HELCO is unable to change the protection settings of the DG, a curtailment interface could mitigate many of the issues caused by the nuisance tripping.

6 Regulation and Ramp Rate Analysis

HELCO provided EPS with one year's worth of SCADA data from each of their solar measurement stations located at substations throughout their system. EPS subcontracted with Clarity Analytical LLC to analyze this solar data. The solar measurements were given weighting factors using the distributed DG capacity expected to be installed on the HELCO system. These weighting factors represent the percentage of total system DG capacity that is in the area of the measurement. The total expected distributed generation is 43 MW, so if a substation has 2.15 MW of capacity, it would be assigned a weighting factor of 5%.

Clarity Analytical interpolated and adjusted the spot measurements to account for timestamp errors, validated the data, performed quality control, and provided EPS with a system-wide solar power time series. This system-wide solar power time series was created by multiplying the weighting factors assigned to each solar measurement station and the distributed solar capacity in the vicinity. This system-wide solar power time series can be used to estimate the total system PV generation connected to the HELCO system and can be scaled for different levels of PV generation capacity. A report detailing the methods used when creating the solar data series is attached in Appendix F.

EPS incorporated this solar data with the measured wind generation in order to determine the total renewable ramp rates and regulation needs for three (3) different PV penetration levels of 30 MVA, 60 MVA, and 90 MVA. Several different time frames were studied for renewable ramps ranging from 30 seconds to 20 minutes. These ramps were used to estimate the necessary amount of regulation, as well as the necessary unit ramp rates. These ramp rates could be used to define the minimum unit combinations required to meet the renewable ramping needs. The ramp rates take into account the wind farms at HRD and Tawhiri in addition to the solar ramp data. There are approximately 15.8 million two-second scans in a year. EPS calculated the renewable ramps on a rolling basis such that every two-second scan has an associated renewable ramp. The renewable ramps were then sorted by the ramp size.

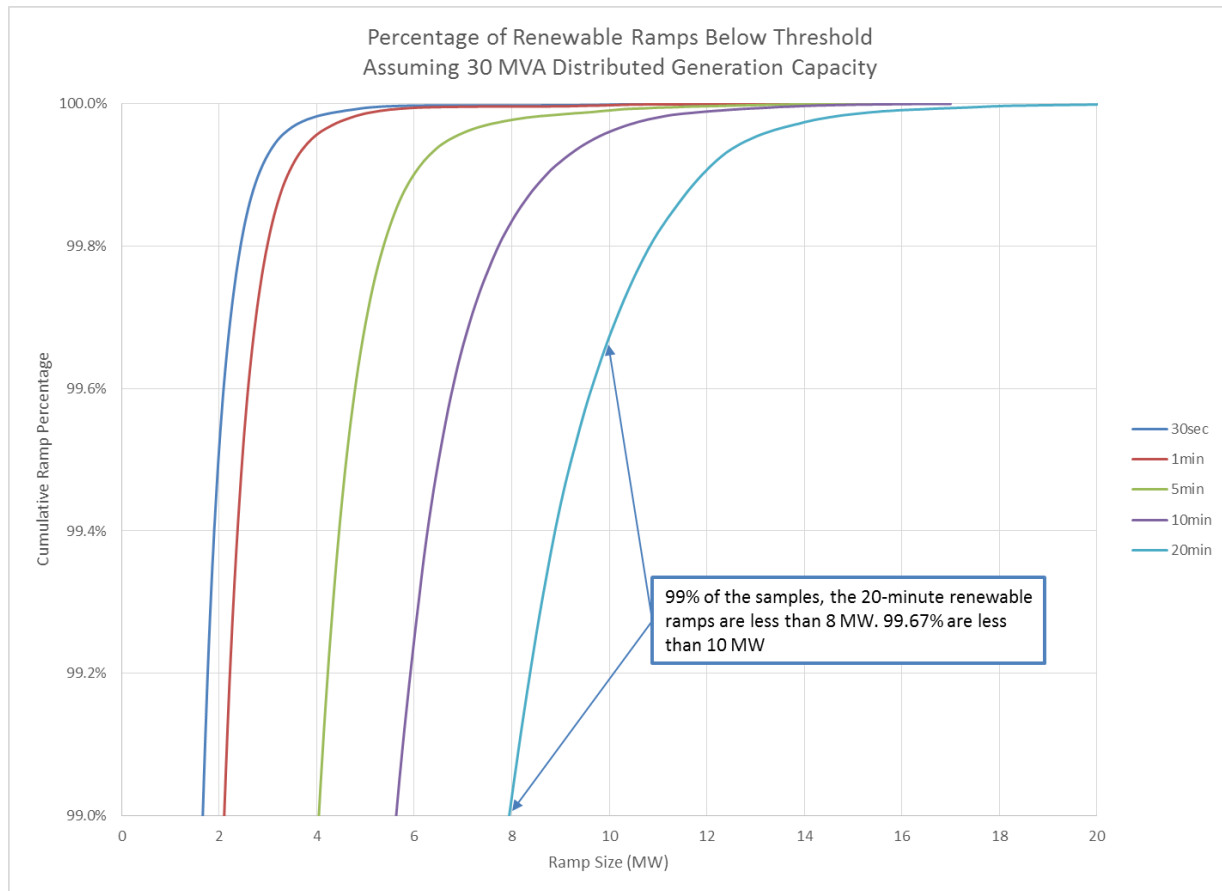

Figure 15: Cumulative Ramp Rate Results 30 MVA PV Capacity

Figure 15 shows the cumulative renewable ramps for one year of SCADA data assuming 30 MVA of installed PV capacity. The traces show the largest 1% renewable ramps on the HELCO system for the five different time frames analyzed. As the callout box in the figure shows, 99% of the samples for the 20-minute ramps are less than 8.0 MW in 20 minutes. Approximately 99.65% of samples have 20-minute ramps that are less than 10 MW. The results of this analysis is attached in Appendix G.

The system generation must, at all times, match the system load. A mismatch between load and generation will cause the system frequency to deviate from 60 Hz and potentially put the utility in violation of frequency regulation standards and increase the likelihood of UFLS should an event occur. The utility must maintain both adequate regulating reserve capacity and adequate unit ramp rates to maintain the system frequency. Since frequency regulation is generally considered to be a sub-minute system constraint, the 1-minute ramps are likely the best ramps to use when determining regulation requirements. A similar analysis was performed for the RSWG study for the system ramping requirements. The ramp analysis for that study was performed with both the wind generation and the system load. The results in this study expanded the ramp rate requirements to include the impacts of the solar generation.

EPS selected the 99.9% threshold for the 1-minute ramping requirement. This level was selected because the remaining 0.1% of the samples works out to approximately 8.8 hours throughout a year that the load and generation ramps will exceed the ramping capability of the units. The assumption is that the risk that the units will not be able to meet the load and

renewable generation ramps is acceptable. With the provided data, HELCO could easily determine the ramp rate requirements if they decide that 99.9% is too lax or strict.

The ramp rate analysis was also performed for the system load as a part of both this study and the RSWG study. The results of the system load ramping analysis showed that the load ramps for a 1-minute ramp were 1.5 MW/min. This ramping requirement will be added to the renewable generation ramping requirement to get the total ramp rates necessary to maintain system frequency.

The 1-minute ramp threshold with 30 MVA of installed PV capacity was 3.4 MW/min. The resulting total ramping needs is 4.9 MW/min when the load ramp needs are added. The ramping needs increase as the total PV generation capacity is increased to 60, and 90 MVA. The 99.9% threshold for 1-minute ramps for 60 and 90 MVA of solar capacity is 5.2 MW and 7.5 MW respectively. The summary of these results is shown below in Table 21.

Table 21: Ramp Rate Needs by Installed Solar Capacity

Solar Capacity	1-Min. Ren. Gen. Ramp	1-Min. Load Ramp	Recommended Ramp Capability
30	3.4	1.5	4.9
60	5.2	1.5	6.7
90	7.5	1.5	9

Assuming the PGV and Hu Honua units are operating, Table 22 shows the unit ramp rates that could be used in various combinations in order to maintain the minimum recommended ramp rate.

Table 22: HELCO Unit Ramp Rates

	Ramp Rate	AGC ECON LIMIT	
		Maximum	Minimum
Hill Unit No. 6 (steam)	2.00	20.00	13.00
Hill Unit No. 5 (steam)	2.50	13.50	6.00
Puna Steam Plant (steam)	2.00	15.50	8.00
Shipman Unit No. 3 (steam)	0.30	6.80	5.05
Shipman Unit No. 4 (steam)	0.30	6.70	5.00
Kanoelehua CT-1 (gas turb, frame 5)	1.00	10.25	2.00
Keahole CT-2 (gas turb, solar)	2.00	13.80	7.50
Puna CT-3 (gas turb, Im2500)	2.50	19.00	8.00
Keahole CT-4 (gas turb, Im2500)	2.50	20.00	8.00
Keahole CT-5 (gas turb, Im2500)	2.50	20.00	8.00
Keahole 1CTCC	2.50	24.50	10.00
Keahole 2CTCC	2.50	53.50	17.00
PGV (geothermal)	1.00	34.60	22.00
HEP 2 UNITS CC (2 Im2500 + 1 Steam)	2.00	58.00	19.50
HEP 1 UNIT CC (1 Im2500 + 1 steam)	2.00	28.00	10.00
HEP 1 UNIT SC (1 Im2500)	2.00	20.80	6.00
Hu Honua (future)	1.00	21.50	10.00
Waimea D-12 to D-14 (emd diesel)	2.00	2.50	2.40
Kanoelehua D-15 to D-16 (emd diesel)	2.00	2.50	2.40
Keahole D-21 to D-23 (emd diesel)	2.00	2.50	2.40
Kanoelehua D-11 (fairbank morris dsl)		2.00	
Panaewa D-24 (cummins diesel)		1.00	
Ouli D-25 (cummins diesel)		1.00	
Punaluu D-26 (cummins diesel)		1.00	
Kapua D-27 (cummins diesel)		1.00	

Table 23 below lists the minimum unit requirement as determined during the RSWG study. The potential ramp rates associated with each generation configuration has been added to the column on the right.

Table 23: Minimum Unit Configurations

Requirement Description	Config.	# of Large Units	Ramp Rate
Base Condition: Two large steam units* + 1CTCC at Keahole	1	4	6.5 to 7.5
1CTCC at Keahole + 1CTCC at HEP	2	4	5.5
1CTCC + 1 large steam unit + 1 Simple Cycle CT	3	4	6.0 to 8.0
3 large steam units (No combustion turbine generation)	4	3	6.0 to 7.0
2 large steam units + 1 CT (exception: Hill 5)	5	3	6.0 to 7.5
1 large steam unit + 1CTCC (exception: Hill 5)	6	3	4.0 to 5.5
*Large steam unit = Hill 5, Hill 6, Puna Steam, Hu Honua, 2 Shipman Units			

- Configuration 1 could reach 6.5 MW/min with (PGV, Hu Honua, Hill 5, Keahole 1CTCC [1+1+2+2.5=6.5]) or 7.5 MW/min with (PGV, Hill 5, Hill 6, Keahole 1CTCC [1+2+2+2.5=7.5]).
- Configuration 2 could reach 5.5 MW/min with (PGV, HEP 1CTCC, Keahole 1CTCC [1+2+2.5=5.5]).
- Configuration 3 could reach 6.0 MW/min with (PGV, Hu Honua, Keahole CT-2, HEP 1CTCC [1+1+2+2=6.0]) or 8.0 MW/min with (PGV, Hill 6, Puna CT-3, Keahole 1CTCC [1+2+2.5+2.5=8.0]).
- Configuration 4 could reach 6.0 MW/min with (PGV, Hu Honua, Hill 5, Hill 6 [1+1+2+2=6.0]) or 7.0 MW/min with (PGV, Hill 5, Hill 6, Puna Steam [1+2+2+2=7.0]).
- Configuration 5 could reach 6.0 MW/min with (PGV, Hu Honua, Hill 6, Keahole CT-2 [1+1+2+2=6.0]) or 7.5 MW/min with (PGV, Hill 6, Puna Steam, Keahole 4 [1+2+2+2.5=7.5]).
- Configuration 6 could reach 4.0 MW/min with (PGV, Hu Honua, HEP 1CTCC [1+1+2=4.0]) or 5.5 MW/min with (PGV, Hill 6, Keahole 1CTCC [1+2+2.5=5.5]).

With 30 MVA of solar generation capacity online, most of the minimum unit configurations provide acceptable ramp rate characteristics. However, when the solar capacity reaches 60 MVA, the minimum unit configurations may not be able to provide sufficient ramping capability to regulate the intermittent solar resource and may make certain generation configurations unworkable. When solar capacity reaches 90 MVA, none of the minimum unit configurations would be able to provide adequate ramping capability and would require that a) additional conventional units be online, b) the unit ramp rates are increased through unit improvement, c) additional system resources such as demand response or storage systems be online, or d) a combination of these to provide the necessary regulation.

As the amount of PV generation connected to the HELCO system increases, the daytime load will decrease. Two significant and compounding issues arise when the daytime load decreases due to additional distributed generation. The utility will need to a) run with fewer units online due to minimum unit loading, and b) the solar ramping needs will increase with additional PV.

In addition to the short term ramping requirements associated with regulating the intermittent wind and solar resources, the conventional generation must also have the capacity to regulate for longer-term ramps from the renewable generation. To quantify the necessary generation reserve requirements, ramp rate analysis was performed for 30 MVA, 60 MVA, and 90 MVA of distributed solar generation capacity plus installed wind capacity. For this analysis, a different data visualization is helpful, an example plot is shown below in Figure 16. The results of the reserve requirement analysis is attached in Appendix H.

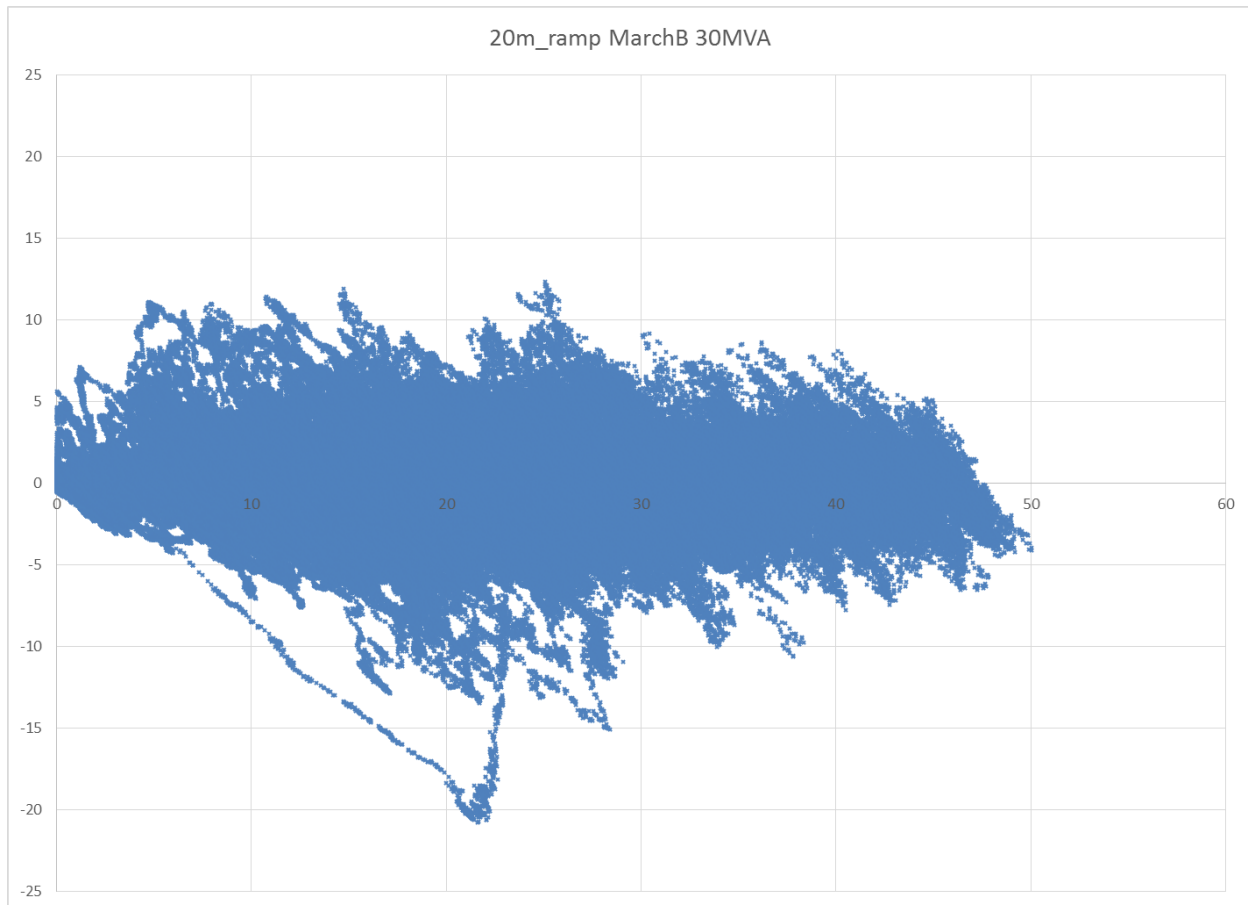

Figure 16: 20-Minute Scatter Plot for March 16-31 with 30 MVA Solar Capacity

Figure 16 shows the worst case down ramp for the renewable generation on HELCO system with 30 MVA of solar capacity, Tawhiri wind farm, and HRD wind farm. The x-axis shows the initial power output of the renewable generation. The y-axis shows the total change in wind power between the initial power and 20 minutes after the initial power point. The plot can be interpreted as follows for a point of (20,-10). The initial total renewable generation power output was 20 MW. Twenty minutes later the renewable power output was 10 MW. Therefore, a net change of -10 MW of renewable generation was experienced over those 20 minutes. The figure shows the worst case down ramp event, and is a single ramp event during which approximately 21 MW of renewable generation was lost in a 20 minute period. This is approximately 1 MW/minute ramp over a 20 minute period. The HELCO units could easily meet the ramp rate requirement, but the 20 MW capacity would be needed.

The 20 minute time frame was chosen to represent scenarios such as a wind ramp down event, followed by some time delay before a decision is made to start another combustion turbine or other fast start unit, plus some time delay to get the unit online and taking load. These time delays are estimated to be approximately 20 minutes. More or less regulation capacity may be required based on actual system conditions. This analysis only shows the capacity required for renewable ramps and does not include the generation capacity necessary to regulate the system load.

The worst case 20-minute regulation requirements for the system with existing wind farms, and 30 MVA of solar generation is +/- 21 MW. When the solar capacity is doubled, the worst case only increases to +/- 24 MW. Finally, when the solar capacity reaches 90 MVA, the total

regulation necessary is approximately +/- 29 MW. When compared to the sub-minute ramp rates seen in the ramp rate analysis, the 20-minute time frame scatter plots suggest that large, sustained, fast renewable ramps are unlikely. With 120 MW of solar and wind capacity, total renewable ramps are not expected to exceed 30 MW over a 20-minute time frame. An important observation is that while the wind is less variable in the short term (30-seconds to 1-minute), it is more likely to go from full output to zero in the longer term (20-minute) when compared to the solar generation with the exception of obvious solar ramp times during dawn and dusk.

7 Protection

7.1 Introduction

The study evaluated four levels of PV penetration on all distribution circuits, namely 50%, 75%, 100%, and 125% penetration level based on the daytime minimum circuit load. HELCO provided the daytime minimum circuit loading and the information is from HELCO's *DG_Totals_Freq_Current.xls*. The scope of the study was limited to the circuits where load was provided. Also, due to the scale of the study, the protection portion of the study was broken into parts and addressed in the order of issues that would come as the penetration level is increased. As the penetration level increases the main concerns are the issues of temporary overvoltage conditions that arise due to single line to ground faults, islanding, temporary overvoltage due to load rejection, and reclosing. Each of these issues, and more, will be discussed in further detail later.

Next, where applicable, the protection review divided the distribution circuits into categories where common designs will naturally yield common recommendations in terms of PV penetration. The substation transformation voltages were used as a common grouping followed by the size of the transformation. The three voltage transformation groups are:

- 69/12.47 kV Connections
- 34.5/12.47 or 4.16 or 2.4 kV Connections
- 13.8 kV Connections

For the first group, there are only a few sizes of distribution substation transformers connected to the 69 kV transmission system. The transformer sizes are 10, 7.5, 5.0, and 3.0 MVA (OA) or less. The transformers may or may not have fans that will provide a rating of 1.25 times the OA rating. There are two main standard settings for the distribution feeders based on the transformer size. The 10.0 and 7.5 MVA transformers use common protective relay settings. The 5.0 MVA transformers use the second relay setting group. The distribution protection settings are set to coordinate with the Kearny "N" 100 Amp fuse at 12.47kV. However, the smaller size transformers for the same voltage may require smaller maximum distribution fuse sizing.

The 34.5 kV system comprises five radial sub-transmission circuits. There are 18 substations where the largest substation transformers are 5.0 MVA and the smallest three phase substation transformer is 0.33 MVA. The study uses the commonality in the 5.0, 2.5 and 1.5 MVA substation transformers that can be looked as 5 groups due to the secondary voltages and comprise 14 of the total 18 substations. The remaining 4 substations will yield unique protection requirements.

There are seven radial 13.8 kV circuits and all are unique. In addition, the 1100 line that is considered transmission is also used as distribution and is unique.

Next, the substation transformers were examined briefly to examine protection concerns. Lastly, as penetration levels increase, there are some transmission considerations for a small group of transmission and sub-transmission lines that should be considered.

7.2 Assumptions

Some assumptions were made based on the information provided by HELCO. This section discusses them.

7.2.1 Distribution Protection Guidelines

The required protection for the distribution circuit has numerous dependencies and the approach taken in this study was to simplify the process based on the following assumptions.

- The generation addition is only PV inverter technology. However, there are a few cases where the existing generation will provide exceptions.
- The inverter connections are three phase.
- The existing protection settings are adequate for the distribution circuit loading and system imbalance.

In general, the protective relay settings and fuses must be selective such that they coordinate for the expected fault current. The substation relays must have the sensitivity to be able to detect both three phase and single line to ground faults with adequate margins at the end of the main feeder during minimum generation conditions. One method for setting the overcurrent pickup (51_{pickup}) is to divide the minimum three-phase fault current ($I_{3PH_{min}}$) at the end of the feeder by two. Further, the phase overcurrent pickup must be greater than the maximum load current (ILD_{max}) by at least 30%. Consideration should also be given to allow for cold load pickup, the pickup can be twice ILD_{max} . The phase overcurrent pickup setting must meet the following criteria:

$$\frac{I_{3PH_{min}}}{2} > 51_{pickup} > 2 \times ILD_{max}$$

Similar to the phase overcurrent, the residual ground overcurrent pickup ($51N_{pickup}$) should be less than one third of the minimum single line to ground fault current ($ISLG_{min}$) at the end of the feeder. The balanced load of the circuit does not affect this setting but the unbalanced load must be considered. One criterion is that the residual ground overcurrent pickup must be greater than 20% of the maximum load current (ILD_{max}) if the circuit load unbalance is no more than 10%. Another way of expressing the lower limit of $51N_{pickup}$ is that it must be twice the maximum load imbalance. The residual phase overcurrent pickup must meet the following criteria:

$$\frac{ISLG_{min}}{3} > 51N_{pickup} > 0.2 \times ILD_{max}$$

The two criteria for phase and ground are used to allow for adequate margin for ground fault resistance. The distribution circuit protection settings may be standardized due to the majority of the distribution circuits being relatively short. Another way of expressing this is that the distribution lines are ampacity limited rather than voltage limited. However, the length of the line and the amount of load for the circuit must be accommodated. Significantly longer distribution circuits may have fault levels and maximum load levels such that the two equations listed above cannot be satisfied. When the equations cannot be satisfied, then other protection alternatives must be considered. The circuit can have a recloser installed on the circuit such that the zone of protection is shortened or protective relaying with load encroachment can be installed.

The selection of the relay time-current curve characteristic must be coordinated with branch fuse protection as well as upstream protective devices. The protective device must have 0.2 to 0.3 seconds of margin at the highest expected fault level.

HELCO does not use phase instantaneous ($50I_{pickup}$) or residual instantaneous ($50N_{pickup}$) overcurrent on the distribution circuit protection. Normally these elements would be used to limit loss of life to substation transformers or to coordinate with a close branch fuse. HELCO typically uses extremely inverse time-current curve characteristics that better coordinate with branch fusing. Further, the HELCO system does not have high available short circuit capacity and is more likely to see issues related to low fault currents.

EPS updated the Aspen Oneliner model to include the distribution feeder lengths. The distribution feeder lengths were determined through the use of GIS maps of the circuit and the operational single line diagrams. The operational single line diagrams do not include the conductor and construction information. EPS assumed that the feeder was either 336kcmil AAC or 1000kcmil AL underground cable unless known otherwise. The impedance data was determined using data and construction information from HECO construction standards. The fault currents were determined for the entire network for multiple minimum generation cases to determine the expected minimum fault conditions for the different locations on the system. The results are shown in Appendix I. The cases are:

- Case A – Minimum generation, all hydros, PGV, H5, H6 and Puna. No Wind. This case will provide the worst case for the west side of the big island, 34.5kV on the Hamakua coast and north Kohala.
- Case B - Minimum generation, all hydros, PGV, H5, H6 and Huhonua. No Wind. This case will provide the worst case for the west side of the big island, 34.5kV in Puna and the south point area.
- Case C – Minimum generation, all hydros, PGV, Huhonua, 1CTCC at HEP and Keahole. No Wind. This case will provide the worst case for west side of the big island, 34.5kV in Puna and the south point area.
- Case D – Maximum generation, all hydros, PGV, Huhonua, H5, H6, Puna, 2CTCC at HEP and Keahole. No wind
- Case E – Maximum generation, all Hydro, All conventional generation online. No wind.

A fault resistance of 0, 0.5, 1.0, 2.5, 5.0, 10, 25, 50 and 1,000 ohms was applied to each of the minimum generation cases for sensitivity analysis.

7.2.2 Aspen Oneliner Model

HELCO provided EPS with several Aspen Oneliner models. The models were:

- Arc Flash Normal Generation.olr – The emphasis of the model was for the distribution system protection. The transmission protection was not modeled.
- HELCO System with PGV Expansion Max.olr – The emphasis of the model was for the transmission system protection during maximum generation. The distribution system was not modeled.
- HELCO System with PGV Expansion Min.olr – The emphasis of the model was for the transmission system protection during minimum generation. The distribution system was not modeled.

The Arc Flash Normal Generation model was reviewed and updated by EPS. The majority of the line impedance was updated using HELCO Line Z Calcs_2009_0129.xls. There were topology corrections made at Kailua, 8200 line by Waiko Tap and Waiko W2, Waimea, and Shipman. The transformer data was updated using HELCO_Tsf Z Data_rev_100115.xls as well as other supplemental information requests.

The two PGV expansion models were briefly reviewed but are used mostly for the transmission line protection only. The Arc Flash Generation model has more detail concerning the distribution which is was the focus of this portion of the study.

7.3 Distribution Circuit

There are many issues that arise when adding inverter based DG to a distribution circuit. This section will address the issues by topics. The topics follow a logical progression as follows:

- Load Analysis
- Circuit Protection
- Distribution Circuit Pick-up Sensitivity
- Distribution Fusing
- Overvoltage Issues
- Grounding
- Interconnection Equipment
- Distribution Transformer
- Communication for Protection
- Reclosing and Synch-check
- Under Frequency Load Shedding

Each of the above topics will be covered in turn.

7.3.1 Load Analysis

Load analysis is a key element in determining what issues arise when DG is being added to the distribution circuit. The distribution circuit must be analyzed with regard to possible islanding conditions and the native load in that island. The native load is the load on the circuit breaker that may be hidden by the DG. The simplest approach is to consider the entire distribution circuit's connected DG and the native load. However, if a recloser is added to the distribution circuit, then the portion of the distribution circuit's native load and connected DG must be considered separately making two potential islanding cases. HELCO did not provide the load information to allow this level of granularity. HELCO did provide the minimum day load for the distribution system and the study is to assume DG penetration levels of 50%, 75%, 100% and 125%. These circuits' loads are shown in Appendix J.

The predominate penetration of DG on the HELCO distribution system is PV and is assumed for this analysis. One method to determine the minimum loading is to find the distribution circuits' minimum and maximum load and using a typical load profile, determine what the minimum day loading would be that is being masked by the generation. This method requires that the load profile of the circuit is known. Another method can be considered since HELCO provided a year of MW data for the distribution circuits taken every 15 minutes. A typical daily PV power

output profile in per unit was applied to each day and every data point converted to a power output by the connected DG on the distribution circuit. The DG output power was then added to the corresponding data point in the circuit load reading to adjust for having the DG on the circuit. The end result is to obtain the actual load assuming full sun. The maximum, minimum, day-maximum and day-minimum load levels were determined for every day of the year and then plotted. However, the focus of the plots is to determine the day-minimum load. The plots can be found in Appendix J. In general, the values for the minimum day load show a slight decrease in native load when compared to day-minimum loads provided by HELCO for the study. However, there were a few noticeable differences around Kahaluu substation, Kailua 11, Kamuela 11, Panaewa 11 and Mauna Lani 14. The difference amount for Panaewa 11 is approximately the size of the dispersed diesel.

The amount of native load on the distribution circuit is critical in determining what mitigation steps are necessary for a given DG penetration level. The possibility of load shifts can further exacerbate the balance of load and generation on the circuit such that load and the aggregate generation levels following islanding are more closely aligned. The distribution circuits with high penetration levels should be reviewed for any load transfers and how the transfers would impact the day minimum load to generation ratio.

7.3.2 Circuit Protection

The distribution circuit protection consists of non-directional time overcurrent phase (50/51) and residual ground (50/51N) overcurrent relays. All the backup protection for the distribution circuit is non-directional time overcurrent relays for both phase and residual phase current and utilize CTs on the high side of the transformer. In general, the transformer high side relays trip the distribution breaker(s). All the overcurrent relays have extremely inverse (EI) curve characteristics with exception of a few very old electro-mechanical relays that have a very inverse (VI) curve. In general, the relay settings are standard and fully coordinate with the 100A Kearny N fuses for the 10, 7.5 and 5.0 MVA transformers. Upgrades for the circuit protection will be discussed later. There is an automatic re-closing relay (79) for distribution circuits and will be covered later in this report.

As the ratio of day minimum load to installed DG decreases the protection scheme will need to be changed depending on the ratio. The initial impact to the circuit protection is the need to add equipment that allows Direct Transfer Trip (DTT) of the DG. The next impact to the circuit protection is to require directional control of the overcurrent elements when the load to generation ratio decreases to one and lower. DTT must be established forcing the load to generation ratio to stay above one by removing the generation prior to opening the distribution circuit breaker. In general, this requires the upgrade of the protection to use microprocessor based protection. The discussion of the upgrade recommendation will be covered in more detail later in this report.

7.3.3 Distribution Circuit Pick-up Sensitivity

Based on the criteria provided earlier, the minimum three-phase and single line to ground fault current were determined for the end of the main feeder for the distribution feeders that for which loads were provided. HELCO provided both the operational distribution single line diagrams and the GIS feeder maps. The purpose of the pick-up sensitivity analysis is to determine if circuit phase and residual ground pick-ups were sensitive enough to meet the suggested margins. The possible areas for concern are on longer distribution feeders that are fed from

substations are on the 34kV system or fed from substations in the South Point area. These are areas of the HELCO system that are weak. The circuits are shown in Table 24.

Table 24: List of distribution circuits with possible overcurrent pickup issues

HELCO SUBSTATION CIRCUIT OVERCURRENT PICK UP ISSUES						
Substation Name	Circuit Name	51 (Amps)	51N (Amps)	Length and Type of Feeder (kFT)	Minimum End of Circuit	
					Phase (Amps)	Gnd (Amps)
Hawaiian Beaches	12	470	270	12.6 - 11 336AL	700	709
Kurtistown	11	340	240	50.3 - 11 336AL	656	487
Kurtistown	12	340	240	50.4 - 11 336AL	655	486
Royal Hawaiian	11	240	150	34.5 - 11 336AL	488	449
Ainaloa	11	600	300	28.5 - 11 336AL	1,192	863
Kapua	12	480	300	51.3 - 11 336AL	682	495
Kealia	11	400	200	78.2 - 11 336AL	508	349
Punalu'u	11	480	300	30.6 - 11 336AL	870	691
Punalu'u	12	480	300	44.3 - 11 336AL	710	534
Puukapu	11	480	240	79.7 - 11 336AL	509	346
South Point	12	300	200	36.6 - 11 #4Cu	508	413
Shipman	12	319	158	10.0 - 11 336AL	634	642
Hakalau	1	340	NA	21.4 - 4 3/0AL	337	NA
Halaula	1	600	NA	10.0 - 11 336AL	787	NA
Honomu	1	340	NA	10.0 - 4 3/0AL	710	NA
Kapoho	13	460	180	61.4 - 11 336AL	688	458

These circuits need to be reviewed again to determine if overcurrent relay settings need to be revised, a recloser be installed, or fusing be upgraded. The feeder length and type may not be accurate since EPS needed to make some assumptions about the feeders based on the drawings provided by HELCO. The full list of the feeder settings and the fault levels can be found in Appendix K.

Appendix K also includes the fault current levels for different levels of fault resistance. A ground resistance was inserted for single line to ground faults at the end of the circuits. Only the circuits that are wye grounded were examined. Distribution ground resistance is considered low where the fault resistance is less than 1 ohm. However the higher resistance faults fall into two basic groups. The first grouping occurs when the resistance is about 25 ohms and the next is at 1,000 ohms. The fault resistances used in this analysis are 0, 0.5, 1.0, 2.5, 5.0, 10.0, 25.0, 50.0 and 1,000 ohms. For this review, if the fault level fell below 160% of the pickup, then the tripping of the relay is questionable. Normally, the fault level should always be maintained above 150% of the pickup. Again, the analysis was grouped by transformer MVA and voltage type.

The analysis showed that when the fault resistance increased above the 25 ohm level on the 7.5 and 10 MVA transformers' circuits, the fault levels fell below 160% of the relay pickup. The 69-12.47 kV, 5.0 MVA transformer grouping were more sensitive to the fault resistance as seen below:

- Kapua 12 – 2.5 ohms or greater
- Kealia 11 – 5.0 ohms or greater
- Punaluu 11 – 10.0 ohms or greater
- Punaluu 12 – 5.0 ohms or greater

- Puukapu – 0.0 ohms or greater
- South Point 12 – 10 ohms or greater

The 69-12.47KV, 3.0 MVA and less transformer grouping showed better results than the 7.5 and 10 MVA group. Some of the circuits that come from substation transformers connected to the 34.5KV system showed poor results. The following circuits also failed to meet the 160% threshold: Kurtistown 11 and 12, Hawi 1 and 2, Ookala 11 and Pa’auilo 1 when the fault resistance was 10.0 ohms or greater.

There are distribution relays specifically designed for high impedance fault detection. These detectors look for “signatures” that high resistance faults exhibit. However, there operational issues associated with these relays. Most utilities only use the relays to provide an alarm and not trip. The utility would have to then go and look for the cause of the alarm which may be difficult to find. The distribution circuit may need to have momentary outages to determine the location by removing parts of the system to determine where the fault is. This method is slow and a nuisance to customers.

7.3.4 Distribution Fusing

HELCO’s distribution fusing practice is to install the largest allowable fuse size for the branch fuse to the main distribution feeder that coordinates with the distribution circuit breaker relay settings. In general, HELCO will place a fuse at the beginning of a lateral coming off the main feeder. Likewise, the cascaded fuses from the branch fuse must be checked with the maximum available fault current for coordination. There are many instances on the HELCO system where the cascaded fusing goes to 4 levels. EPS suggests that the number of cascaded fuses should be limited to no more than 3 levels. There is little economic or reliability justification for installing 3 levels of fusing. Also, using cascaded fuses of the same size should be avoided. For example, the branch and the cascade sub-branch fuse requirements are shown in Table 25 and Table 26 respectively.

Table 25: Branch Fuse Requirement

BRANCH FUSE REQUIREMENT	
Minimum Branch Exposure	Usage Limitation
2,000 feet	None
1,200 feet	Likelihood of severe weather, tree or animal/vehicle contact.
none	Experienced 3 or more outages in the past 3 years.

Table 26: Sub-Branch Fuse Requirement

SUB-BRANCH FUSE REQUIREMENT	
Minimum Branch Exposure	Usage Limitation
10,000 feet	75% of load (branch and sub-branch included) must be on the substation side of sub-branch fuse and the fused sub-branch must be either 2000 feet long without limitation or 1200 feet provided there is a likelihood of severe weather, tree or animal/vehicle contact.
none	Branch experienced 3 or more outages in the past year.

In Tables 25 and 26, the minimum branch exposure refers to the total branch circuit footage served by the fuse (branch and sub-branch).

Fuse Mis-Coordination Issues

The operational single line diagrams do not include all the fuse sizes so a complete review is not possible. However, there are numerous instances where the fusing needs to be reviewed. For example, Hawaiian Beaches Substation circuit 11 has a 100 Amp type N fuse installed on P-12, Kahaka Blvd. The note on H-01039 indicates that the 100 Amp type N fuse was used to coordinate with the substation but also to allow load transfer to Ainaloa circuit 11. The next cascaded sub-branch fuse is a 65 Amp type N on P-13 as the circuit proceeds on Puni Mauka Loop North. However, sub-sub-branch fuses on Alamihi Street and Hou Street are 65 Amp and 50 Amp type N respectively. Neither of the sub-sub-branch fuses coordinate with the 65 Amp type N sub-branch fuse and could cause confusion in trouble shooting in the future. Another example is on H-01035 that shows the distribution circuit for Hawaiian Paradise Park sub-division. There are numerous examples where the cascaded distribution fuses are either the same size or are sized such that they will not coordinate.

Although the HELCO system does not have large fault currents on the distribution system, care should be taken to ensure coordination between cascaded fuses in the low ampere range. For example, the highest fuse that the 100 Amp type N fuse will safely coordinate is the 65 Amp type N and only to a maximum fault current level of 3,300 Amps. The maximum three phase fault level of a 10 MVA transformer at 12.47kV is around 5,500Amps. Use of a 50 Amp type N will coordinate with the 100 Amp type N fuse to a maximum fault level of 4,300 Amps. The maximum fault current level allowed between the smaller fuses is significantly smaller than 4,300 amps.

7.3.5 Overvoltage Issues

There are two main causes of temporary overvoltages when dealing with significant amount of DG on the distribution system. The first type is load rejection and the second is a temporary neutral shift due to a L-G fault. For both of these conditions the overvoltage potential is mitigated when the load is greater than the generation on the feeder following islanding.

Temporary overvoltages associated with load rejection occurs when the aggregate DG on the distribution circuit is in excess of the distribution load when the distribution circuit breaker opens. If the circuit breaker opens when the ratio of load to DG is larger than or equal to 1.0, meaning that there is no reverse flow at the distribution circuit breaker, no temporary overvoltage is

expected. However, if the ratio of load to generation is less than 1.0, then the voltage will rise in proportion with the decrease in the ratio.

Neutral Shift for single-line to ground (L-G) faults and following islanding from the power system, inverter based systems has the potential to develop overvoltages approaching 2.0 p.u. The overvoltage potential is mitigated due to the mismatch between load and generation on the feeder following islanding. The ratio of minimum day load to DG should not be less than 2 without considering mitigation steps to reduce the chance for this temporary overvoltage condition.

When the penetration level of the distribution circuit reaches the study penetration levels (generation to minimum day load expressed in percent) the following mitigation steps must be considered.

- 50% - The ratio of minimum day load to generation level is 2.0. At this level of generation there is the possibility of developing overvoltages due to the neutral shift for a line to ground voltage. At this point, a grounding bank is strongly suggested.
- 75% - The ratio of minimum day load to generation level is 1.3. At this level of generation there is a stronger possibility of developing overvoltages due to the neutral shift for a line to ground voltage. At this point, a grounding bank is required and direct transfer trip (DTT) is suggested. The substation protective relays will need to be upgraded to microprocessor based protection for the DTT.
- 100% - The ratio of minimum day load to generation level is 1.0. At this level of generation there is more possibility of developing overvoltages due to the neutral shift for a line to ground voltage and possible the load rejection. At this point, both a grounding bank and DTT is required.
- 125% - The ratio of minimum day load to generation level is 0.8. At this level of generation there is a stronger possibility of developing overvoltages due to the neutral shift for a line to ground voltage. At this point, a grounding bank is required. The portion of DG that is causing the reverse flow must be cleared prior to opening the distribution circuit breaker. Another alternative is to never allow the reverse flow and to turn off the inverters that are causing the reverse flow until sufficient load is available to prevent the reverse flow.

Also, as previously stated, the load to generation mismatch could be impacted in the future by changes in the distribution feeder configuration or changes in loads.

7.3.6 Grounding

Once the substation circuit breaker opens following a L-G fault, the temporary overvoltage issue occurs because the faulted phase will have its voltage reduced to 0.0 pu L-G, and the non-faulted phases will experience a voltage rise to 1.73 per unit. This voltage increase is due to the ground reference shift caused by the DG which has no ground source. However, a DTT will be issued from the microprocessor relay and the inverter will be tripped but would not occur prior to the main ground source being lost. Prior to losing the main ground source the system is effectively grounded such that the following equations are true.

$$\text{Equation 1: } 0 < X_0/X_1 < 3$$

$$\text{Equation 2: } 0 < R_0/X_1 < 1$$

However, when circuit breaker opens and the ground source is removed, the islanded system is no longer effectively grounded.

The mitigation step is to provide a ground source via a grounding bank. The grounding bank should be sized such that a) the substation's contribution of ground current is enough to ensure that the residual ground overcurrent protection can still detect a ground fault at the end of the protected distribution line and b) still maintain an effective ground source when the circuit is in an islanded condition. The ground fault (3I_o) contribution from the substation decreases in proportion to the size of a grounding bank when installed on the main distribution feeder. The required size of the grounding bank depends on the amount and type of generation being added to the distribution circuit. Basically, the more generation there is then the larger the grounding bank should be. For economic reasons the sizing of the grounding bank should be as large as possible, but not so large as to decrease the ground current (3I_o) contribution from the substation by more than 5 to 7%. The 5 to 7% is a reasonable target without compromising the sensitivity of the residual ground overcurrent relay at the circuit breaker. Also, the grounding bank should be located close to the substation breaker for better coordination with downstream protection devices. When the main ground source is removed, the system will be effectively grounded until the DG can be removed. A method for monitoring the health of the grounding bank should also be installed. If a grounding bank is not available, then the generation level should be reduced such that the ratio of the day-minimum load to connected DG is 2.0 or higher.

Modeling

The modeling of the inverters is difficult as compared to traditional generation concerning their response to faults. There is no standard model for inverter based generation. An inverter has multiple control loops and modeling the control system of a particular inverter takes intimate knowledge that is only available through the manufacturer. The difficulty is further compounded by the fact that there are several different types of inverters on a distribution circuit and each have unique control and protection schemes. Inverters were modeled in Aspen Oneliner as a current limited source. Aspen recommends that if used, the Z1 and Z2 values to be low with respect to Z0. The model assumes that the inverter does not provide a ground source. The program adjusts the positive and negative sequence voltages sources in such a way that the ratio ($|I_2|/|I_1|$) remains constant in the iterative process to solve. EPS assumed the sub-transient, transient, synchronous and negative sequence impedances to be j0.3 pu in the generator model although this is not the true impedance of the DG. The zero sequence impedance of the generator was assumed to be j9999.

The island condition was modeled using Aspen Oneliner version 11.10 as shown in Figure 17. The analysis was completed for both 12.47 and 4.2 KV systems with two configurations each to make four groups. The group's descriptions are as follows:

- **12B0-DG_B0-GB** – This group represents a 12.47KV system with the grounding bank and the DG installed on Bus 0. There are 5 segments of 336kcmil AAC, 12kV overhead distribution. There are six cases, one case for each DG MVA level from 1 MVA to 6 MVA with 6 runs for each grounding bank size. This group is to see the effect to the grounding coefficient ratios as the SLG faults move away from the grounding source. See Figure 17 for the SLD of the model.
- **12B5-DG_B0-GB** – This group represents a 12.47KV system with the grounding bank installed at Bus 0 and the DG installed at the end of the feeder on Bus 5. There are 5 segments of 336kcmil AAC, 12kV overhead distribution. There are six cases, one case for each DG MVA level with 6 runs for each grounding bank size. This group is to

represent having the DG away from the grounding source and fault applied at different locations between the two locations. See Figure 17 for the SLD of the model.

- **4B0-DG_B0-GB** – This group represents a 4.2KV system with the grounding bank and the DG installed on Bus 0. There are 5 segments of 336kcmil AAC, 4kV overhead distribution. There are three cases, one case for each DG MVA level with 6 runs for each grounding bank size. This group is to see the effect to the grounding coefficient ratios as the SLG faults move away from the grounding source.
- **4B5-DG_B0-GB** – This case represents a 4.2KV system with the grounding bank installed at Bus 0 and the DG installed at the end of the feeder on Bus 5. There are 5 segments of 336kcmil AAC, 4kV overhead distribution. There are three cases, one case for each DG MVA level with 6 runs for each grounding bank size. This group is to represent having the DG away from the grounding source and fault applied at different locations between the two locations.

Again for groups 12B0-DG_B0-GB and 12B5-DG_B0-GB, the basic model has five one mile sections of 336AAC OH construction with buses labeled 0 through 5 based on 12.47kV construction. For the 12.47KV analysis, the DG (PV generation) was sized from 1 MVA through 6 MVA in increments of 1 MVA and connected to the PV_GEN bus making 6 cases each. The 4.2KV analyses which are groups 4B0-DG_B0-GB and 4B5-DG_B0-GB only use DG sizes of 1, 2 and 3 MVA making 3 cases each. Delta Grounded-wye transformers were modeled based on the standard overhead single phase transformer sizes and connected to Grd Bnk bus for both voltage levels. The three phase grounding banks modeled are 45, 75, 112.5, 150, 225 and 300 kVA making 6 runs per case. The models were configured to move either the PV_GEN bus or the Grd Bnk bus between bus 0 and bus 5 through switches A through D. As an example, Figure 17 shows run 12B0-DG_B0-GB, which models the 12.47kV system with the 3MVA DG and 112.5 kVA grounding bank both connected to Bus 0 and all other DG units and grounding banks are off-line.

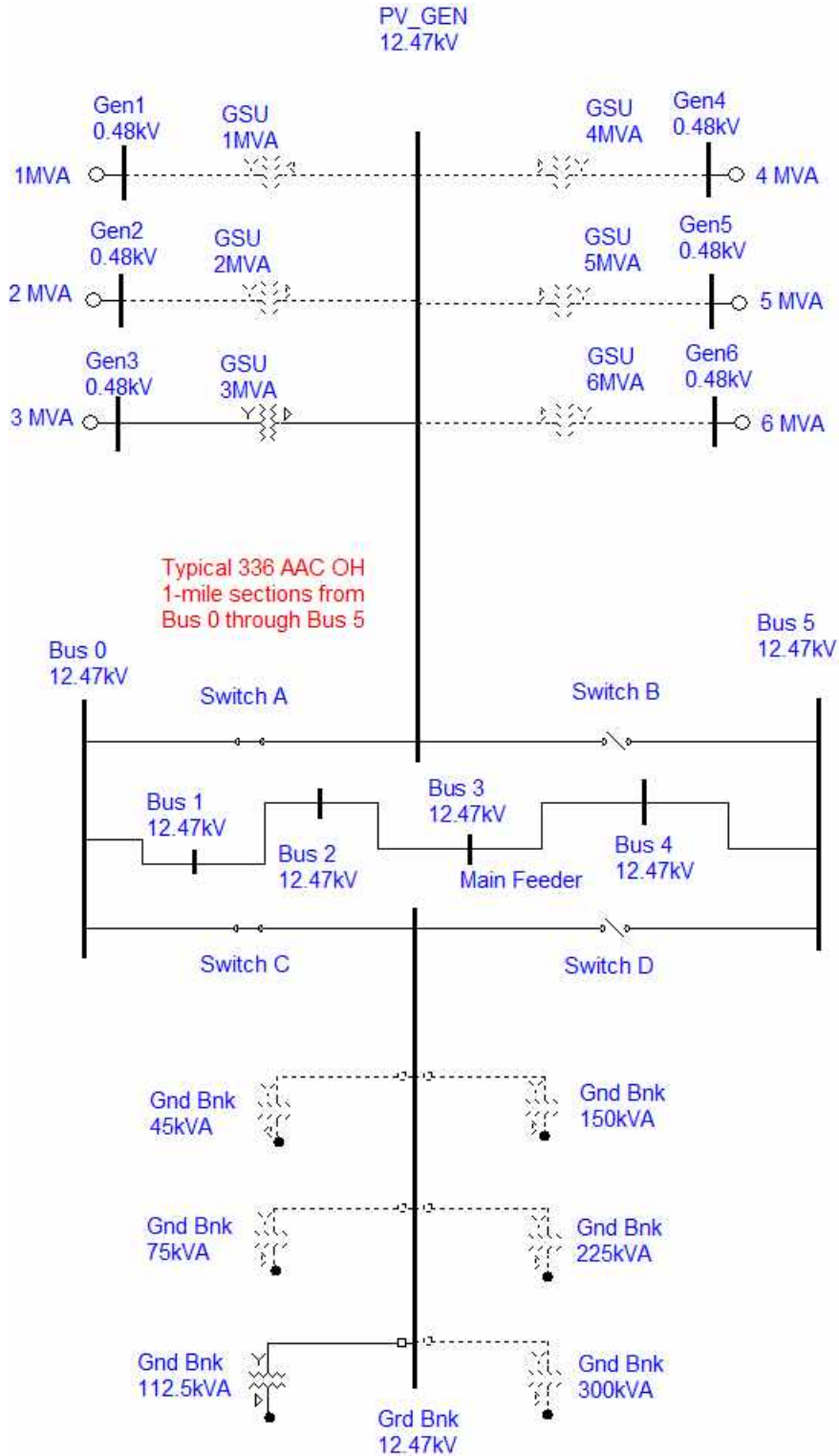

Figure 17: Single line diagram of 12.47kV island model

For the 12.47kV system, the six DG units and the six grounding banks were used to make 36 runs. For each run, a SLG fault was applied at each of the six buses and then the coefficients of grounding (COG) ratios X_0/X_1 and R_0/X_1 calculated. The 36 runs were grouped by the

connected DG to show how the size of the grounding bank changes the COG ratios. In Group 12B0-DG_B0-GB, the 1MVA DG results are shown with the various combinations of grounding banks. The faults were applied and the results are shown in Figure 18. The curves show that as the fault is applied further away from bus 0, the ratios X_0/X_1 and R_0/X_1 generally increase slightly. More importantly is that the ratio drop as the size of the grounding bank is increased. Both sets of curves show a slight convergence. Figure 18 indicates that a 75 KVA grounding bank is required to maintain effective grounding for the R_0/X_1 ratio to be less than 1.0.

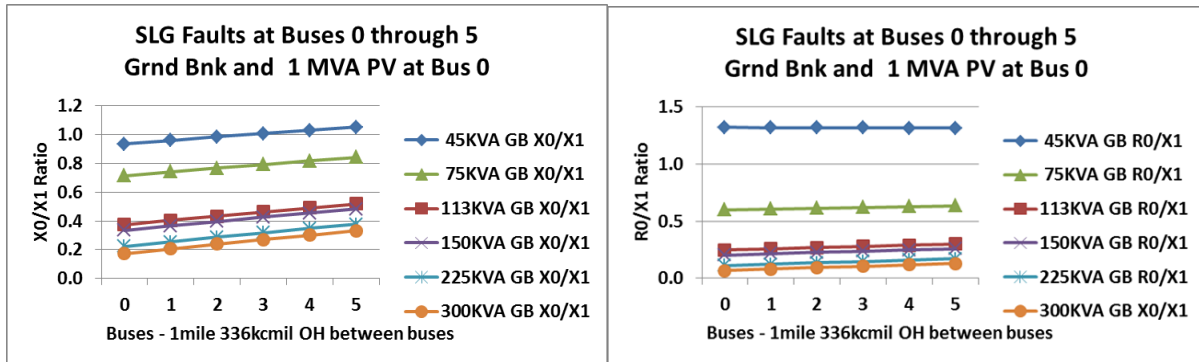

Figure 18: 1 MVA DG and Grounding Bank at Bus 0

Group 12B0-DG_B0-GB, the 3 MVA DG case results are shown in Figure 19. The curves for each grounding bank are shifted up as compared to Figure 18. The X_0/X_1 ratios show the 45KVA grounding bank curve slightly decreases while the 75KVA and larger still increases slightly. The R_0/X_1 ratios show the 75KVA and smaller curves decreasing while the 113KVA are larger slightly increasing. Again, both sets of curves show that curves tend to converge. Figure 19 indicates that at least a 113KVA grounding bank is required to maintain effective grounding based on the R_0/X_1 ratio.

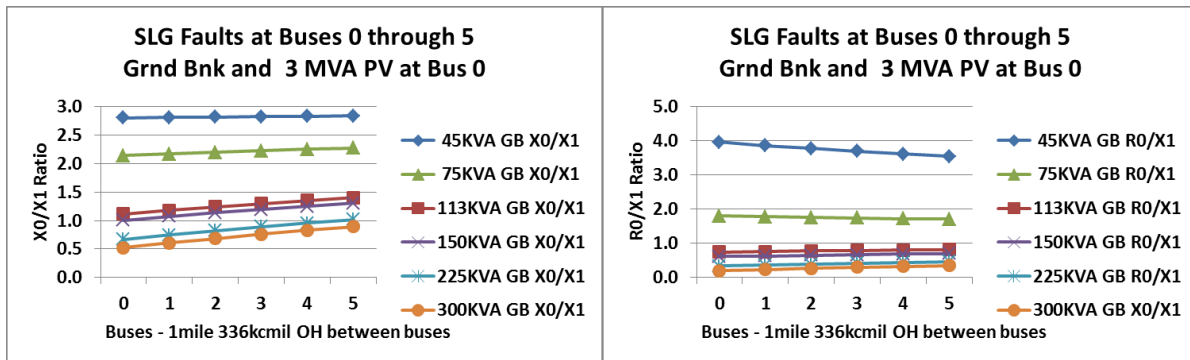

Figure 19: 3 MVA DG and Grounding Bank at Bus 0

As previously mentioned, the amount of DG on the circuit determines the minimum size of the grounding bank. Figure 20 shows how the COG ratios change for SLG faults on bus 0 as the amount of DG is increased for a given grounding bank.

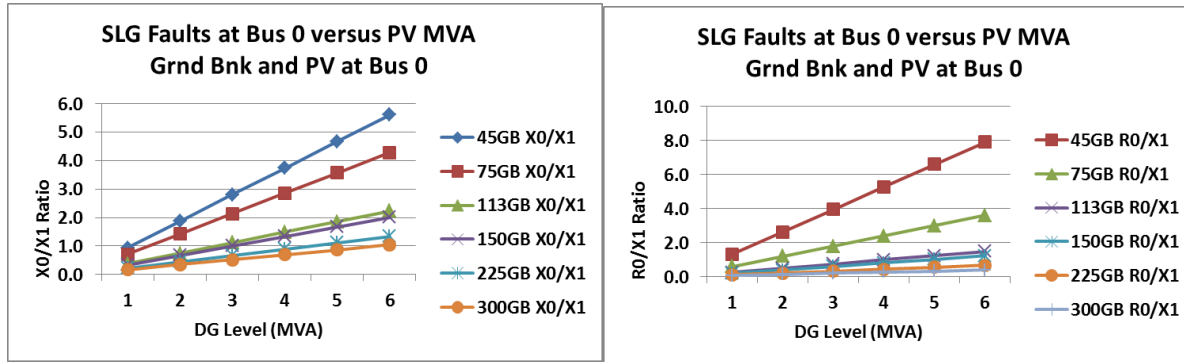

Figure 20: Grounding Ratios Versus DG Level

The analysis was done for the remaining three groups and the results are shown in the Appendix L along with the complete analysis of the group 12B0-DG_B0-GB. The minimum size of the grounding bank for a particular island is dependent on the expected level of DG on the circuit.

HELCO Existing Practice

HELCO has been installing grounding banks on circuits and generally require them when the day-minimum load to generation level is below three (3). HELCO has installed all 75 kVA banks with exception of one circuit that has a 45 kVA. EPS assumes that these are delta grounded wye transformers. Previously, EPS stated that a grounding bank should be installed when the day-minimum load to generation level is below two (2). However, EPS considers HELCO's practice to be prudent considering the dynamics of the distribution system in reconfiguration. Again, the size of the grounding bank is dependent on the size of the DG on the potential island. The largest amount of DG listed of the circuits having a 75 kVA grounding bank is 1,041 kVA which meet the COG requirements.

7.3.7 Interconnection Equipment

Due to the large amount of total DG, it cannot be assumed that the opening of the distribution breaker will result in the loss of the proposed generation due to load/generation mismatch or that overvoltages that occur due to the isolation of the PV inverter systems are dampened by load. As previously discussed, when the ratio of minimum day load to generation level is 1.3 or lower then this indicates that all future additions must have a DTT to remove the DG to maintain a sufficient load to generation imbalance. The existing protective relaying for the distribution circuit must be designed for DTT. Most of the existing protection is electro-mechanical not readily capable of providing DTT. EPS recommends the installation of either a SEL-351A or a SEL-651R to replace the 50/51 and reclosing relays. The existing 50/51N relay should be kept for backup protection if possible. EPS recommends the installation of a SEL-751A at the DG facility. When the distribution circuit breaker (could be a recloser) has been determined to be tripped or opened, a DTT is to be sent to the SEL-751A relay at the DG facilities. HELCO does use the SEL-651R which is also equivalent to the SEL-751A for this application. As the ratio of minimum day load to generation level drops to 1.0 and below, a delay should be applied to the trip signal to the circuit breaker such that the PV plants will cease generation first. The SEL-751A will be programmed to issue an immediate trip to the project's inverters upon receipt of the DTT. EPS also suggests that a main breaker with trip and close capability be installed if the inverter does not have remote trip capability. When the SEL-751A receives the DTT, the relay will also initiate a timer to test if the inverter has shut down, otherwise the relay should trip DG's main breaker once the IEEE 1547 islanding limit has been exceeded. The status of the DG breaker will be sent to the SEL-751A. A larger load to generation imbalance should be

maintained to allow for future smaller DG additions that will not have DTT. For this reason, the pre-approved DG projects should be reviewed.

Another alternative for tripping the DG is for the substation to use the directional element to determine that a fault is present on the circuit and to send a permissive signal to the DG(s) relay. The DG(s) relay can detect the fault via the zero sequence voltage on the circuits but cannot distinguish between circuits from the same ground source. This assumes that the distribution transformer is a grounded wye-grounded wye and the DG's relay has grounded wye-grounded wye potential transformers. However, when the permissive signal is received from the substation, then the DG can be tripped prior to tripping of the distribution circuit breaker.

Proposed facilities must install overvoltage protection to mitigate the chance of overvoltages on the distribution system. The overvoltage protection should detect conditions exceeding 1.15 p.u. on the distribution circuit in less than 3 cycles and shut the inverter off. The SEL-751A has this capability.

7.3.8 Distribution Transformer

In general, the inverters are not grounded and also do not provide a means for a ground source. Many of the manufactures actively avoid this but do want an effectively grounded connection point with the utility. As previously mentioned, the utility also faces the challenge of an islanded distribution system that has generation with no ground source. The distribution transformer has a large impact on what approach should be taken. The two winding transformer zero-sequence characteristics can be summarized as follows:

- Wye - Wye bank, One Neutral grounded; with only one of the neutrals grounded, there is no path for the zero sequence current to flow through the transformer.
- Wye Grounded - Wye Grounded bank; with both neutrals grounded, there is a path for the zero sequence current to flow through the transformer.
- Wye Grounded - Delta bank; the zero sequence current does not flow through the transformer but there is a path from the wye winding since the zero sequence current can circulate in the delta winding.
- Wye - Delta bank; the zero sequence current cannot flow since there is no return path to ground.
- Delta – Delta; the zero sequence current cannot flow since there is no return path to ground.

In distribution circuits where the DG penetration is very low, then there is no issue of high voltage due to the neutral shift when there is a single line to ground fault. The use of a delta – grounded wye transformer can be used. The grounded wye will allow the zero sequence current to flow and will isolate the distribution circuit. However, as the DG penetration increases, the wye grounded – wye grounded distribution transformer provides numerous advantages over the other transformer configurations. The utility can establish an effective ground on the distribution circuit via a grounding bank of suitable size. The grounded wye – grounded wye provides a path for the zero sequence current between the primary and secondary connection. Even if the DG does not provide zero sequence current, a grounded wye – grounded wye potential transformer can be installed so that zero sequence voltage can be measured to sense when there is a ground fault on the distribution circuit(s).

7.3.9 Communication for Protection

There are multiple ways to achieve the communication between the DG site(s) and the substation. The best method really depends on individual circumstance. However, the method needs to have fast transfer speed. The initial step is to identify the grouping of these methods or approaches and describe the capabilities or limitations of them. The list is not meant to be exhaustive but to provide a general approach. These methods are grouped as follows:

- Remote Trip Signal
- Mirror Bits
- GOOSE

There is equipment that allows the high speed transfer trip signal or equipment that replicates a contact closing between sites. A closing of a contact in location A is replicated in location B in less than 16 msec. The point to point method can use a single channel and be bi-directional depending on the communication channel. However, this method does not necessarily mean only point to point but can be point to multipoint. An example of this method might be a multiple address system MAS via radio with a single transmission point and multiple receivers. In general, this is a uni-directional scheme.

Another method of point to point communication is the use of Mirror Bits (MB). Mirror bit is a protocol developed by Schweitzer Engineering Laboratories (SEL) to allow multiple bits of information to be sent between SEL relay pairs. The bits of information can be assigned for any function used in the SEL relay including contact replication. The more recent relays from SEL can use Advance MB. Advance MB can be used with a remote SEL relay to send digital bits to remote SEL relay while the remote SEL relay can send analog information back. The best-fit application for this method would be a single large DG that requires DTT, Trip, Reduce Generation digital inputs and the MW, MVAR, Voltage can be sent back over a single channel. However, the limitation with this method is the number of channels that can be implemented for each circuit.

For area's with a higher number of DG installations that require DTT, EPS proposes that IEC 61850 protocol be used, using GOOSE on a "flat" LAN. The "flat" LAN works using the MAC address in lieu of a routable protocol. This method is easily scalable such that the DTT can be sent to future DG installations. Both the recommended SEL-351A and SEL-751A are capable of using GOOSE and should be purchased with that option. In general, a larger load to generation imbalance should be maintained to allow for future smaller DG additions that will not have DTT.

SCADA

When the size of the DG is at 250kW and larger, SCADA will be required. The addition of SCADA to DTT requires that managed switches be utilized that will allow for prioritization of information. EPS proposes the following for the data collection and control. The DG plant will require an Automation Controller (SEL-3505) for the required plant data and controls. The Automation Controller and the suggested SEL relay will both connect to a managed switch. The project will connect to the managed switch at the substation and HELCO will determine the best communication method. The managed switch at the substation will interface with the SEL-351A and possibly other IEDs. An Automation Controller (SEL 35XX series) will be used to collect data and provide control I/O for system operations via SCADA. The managed switches will prioritize the messages such that there will be minimal impact to the DTT. The SEL Automation Controllers have many master station protocols but the communication interface will be determined by HELCO. The data collection will have a lower priority than the DTT. Further,

engineering access can be allowed to get relay information that will have a lower priority than the data collection. The data priority for this scheme should be in the order 1) protection information, 2) data collection, and 3) engineering access.

7.3.10 Reclosing and Synch-check

There is automatic re-closing relay (79) for the distribution circuits but there is a mixture of reclosing settings. Normally reclosing setting is set for two reclosing attempts with intentional time delays of instantaneous and 15 seconds. The intentional time delay for reclosing should be set over twice the IEEE-1547 islanding clearing requirement of seconds. However, EPS recommends a dead-line check be established if faster re-close times are required or when the ratio of minimum day load to connected DG decreases to 1.0 or less.

7.3.11 Underfrequency Load Shedding

The distribution under-frequency relay (81U) should be supervised by the circuit's directional element on the feeder. Basically, if there is a system disturbance that triggers the 81U relay and directional element for the feeder is reversed indicating that the generation on the feeder exceeds the load, then the 81U relay element is disabled. However, if the DG does not exceed the load on the circuit, the feeder will trip. This method will allow the utility to maintain the feeder for UFLS the majority of the time.

HELCO should periodically revisit the load shedding setting scheme. The addition of the distributed generation will have an impact on the expected response of the load shed relays. The under-frequency load shedding scheme was designed with specific MW levels for the different stages. The addition of distributed generation can create scenarios in which the actual vs. expected tripped load are significantly different.

7.4 Substation Transformers

In general, the protection of distribution substation transformers is by high side fusing with the exception of some that have a high side interrupting device such as breakers or circuit switchers. HELCO has standardized with S&C SMD-2B fuses when used with a few legacy exceptions. The substation transformers that connect to metal-clad switchgear have non-directional phase (50/51) and residual ground (50/51N) overcurrent relays. These relays trip the distribution breaker(s) and if applicable, the high side breaker(s) or circuit switcher. Unlike the distribution circuit overcurrent protection, the transformers also utilize instantaneous overcurrent elements. The substations with reclosers that generally only have fuse protection are a few 5.0 MVA transformers and the smaller units, 2.5 MVA or less. The transformers that have thermal relays (49) will trip the distribution breaker(s). In some cases, transformers in switching stations will have sudden pressure (63) relays. The sudden pressure relay would only be useful where the transformer has high side breaker(s) or circuit switcher. However, all the distribution substation units in switching stations since 1992 have circuit switchers including the Kailua conversion to a switching station in 1994. The protection review of the substation transformers is divided by size and voltages. The categories are as follows:

- 69kV, 10 MVA Transformers
- 69kV, 7.5 MVA Transformers
- 69kV, 5.0 MVA Transformers
- 69kV, 3.0 MVA and Less Transformers
- 34.5kV, 5.0 MVA and Less Transformers

7.4.1 69kV, 10MVA Transformers

There are 32 10 MVA substation transformers on the HELCO system. Of the 32 substation transformers, 14 utilize a high side breaker(s) or circuit switcher that will trip from relay protection. Only three (3) of these 14 substation transformers do not have differential protection and these stations will clear the 69kV bus. These substation transformers are Kahaluu units 1 and 2, and Puueo unit 2. There are also three substation transformers protected by fusing that have differential relaying but no high side breaker(s) or circuit switcher and these stations are Kaloko unit 2, Panaewa and Waikoloa Wells.

HELCO should strongly consider upgrading the protection on all 10 MVA transformers to include differential protection and a high side circuit switcher or Vac-rupter. The differential scheme should include the distribution bus in the zone of protection. This is also a suggested practice in the IEEE Guide for Protective Relay Applications for transformers of this size. Arc-flash energy potential should be identified and detection relays should be added if required. In 2007, the National Electric Safety Code, NESC – 2002 edition was adopted by the State of Hawaii. This standard does not require the utilities to identify or mitigate the arc-flash hazards within the electrical utility system. However, the 2007 edition of NESC requires the calculation and mandates the assessment be performed by utilities by January 1, 2009. This requirement may already be in effect through OSHA regulations within the State of Hawaii and HELCO should investigate its requirements and be pro-active in its implementation.

The standard fuse for the 10 MVA transformers connected to the 69kV system is an S&C 175 Amps. In general there is adequate clearing time between the distribution circuit breaker and the transformer fuse protection. If the distribution circuit breaker fails to clear for a single line to ground fault or the fault is on the distribution bus, then the fault will be very slow clearing if at all. If the substation transformer has breaker(s) or other high side interrupting device, then the high side phase overcurrent relay curve will time out before the 175 Amp transformer fuse. However, if there is no breaker(s) or circuit switcher, the single line to ground will need to evolve into a multiphase fault before clearing in some cases.

7.4.2 69kV, 7.5MVA Transformers

There are six 7.5 MVA substation transformers on the HELCO system. Of the six substation transformers, only one has high side breakers that will trip from relays. The transformer at Honokaa also has differential relaying but no fuses. The remaining six (6) substation transformers have S&C 125 Amp fuses. These transformers are host park, HPP, Kapoho, Waika and Waikoloa. HELCO should consider including the 7.5 MVA transformers with the 10 MVA transformer class in terms of improvements.

7.4.3 69kV, 5.0MVA Transformers

There are ten 5.0 MVA substation transformers on the HELCO system. Of the 10 substation transformers, only two have high side breakers that will trip from relays. The two substation transformers are at Honokaa and Kealia. The Honokaa transformer has no fuse protection or differential relaying but has high side phase and residual ground overcurrent relays. Kealia has differential protection and a 65 Amp DBA fuse. The remaining eight (8) substation transformers have S&C 80 Amp fuses predominately. The documentation indicated that the Kau Hale substation transformer has a S&C 100 Amp fuse and this should be checked.

7.4.4 69kV, 3.0MVA and Less Transformers

There are eight transformers in this group. There are two 3.0 MVA transformers at Hale Pohaku and these have two different size S&C fuses, 65 Amps and 50 Amps. These fuses need to be

standardized to a common size. There are three 2.5 MVA transformers have fuses that are either GE 40 Amp or S&C 50 Amp fuses. These should be reviewed. There are three 1.5 MVA transformers and they have the fuse sizes of GE 20 Amp, GE 25 Amp and S&C 30 Amp. These fuse sizes should be reviewed and standardized.

7.4.5 34.5kV, 5.0MVA and Less Transformers

There are 17 substation transformer units in this group. The transformer size and fuse protection is shown in Table 27. These fuse sizes were obtained from Arc Flash model and grouped in the table to common unit sizes.

Table 27: HELCO 34.5kV, 5 MVA and Less Transformer Fuse Protection

HELCO 34.5kV Transformer 5.0 MVA or less			
Substation	Unit	Fuse Protection	
	OA/FA	Type	Size
Kurtistown	5	S&C	125
Maliu Ridge	5	S&C	100
Mt. View	5	S&C	125
Hawi	2.5	S&C	150
Hawaiian Beaches	2.5	S&C	65
Royal Hawaiian	2.5	S&C	80
Halaula	2.5	S&C	40
Honomu	2.5	S&C	20
Laupahoehoe	2.5	S&C	25
Wright Rd.	2.3	ABB	65
Namakani Paio	1.5	S&C	40
Orchid Isle	1.5	S&C	125
O'okala	1.5	S&C	80
Pa'aulo	1.5	S&C	40
Volcano	1	S&C	40
Hakalau	0.75	ABB	30
Papa'aloa	0.579	S&C	25

The fuse sizes should be reviewed and standardized. The fuse sizes for the 1.5 and 2.5 MVA transformers are very inconsistent. For example, the fuse size for Orchid Isle substation is either 50 amps or 125 amps. The CAD drawing H10223 indicates that the transformer was changed out to a 5.0 MVA but the system single line indicates that it has not. HELCO needs to review the primary fuse protection for substation transformers and standardize where possible.

The addition of the DG at the studied levels does not cause any issues on the substation transformer protection. There are also no system overloads with the studied levels of DG penetration.

7.5 Transmission

As the DG penetration levels increase, there are some transmission considerations for a small group of transmission and sub-transmission lines. There are 29 transmission (69kV) lines of which there are 17 that have distribution substation transformers tapped from the lines. There are six (6) radial 34.5kV sub-transmission lines and all of the lines have distribution tapped from

the lines. There are three (3) 13.8 kV sub-transmission lines and only one has distribution load connected to the line. Each transmission line with tapped distribution substation is a possible island area. The lines without any DG connection do not need further review since the addition of the DG will not affect the reach of the relays. However the remaining lines were reviewed. The issues that arise on the transmission system are similar to that of the distribution system. This section will address the issues by topic. The topics follow a logical progression as follows:

- Transmission Tapped Load
- Transmission Protection
- Transmission Islanding
- Sub-Transmission Protection and Islanding
- Reclosing and Synch-check

7.5.1 Transmission Tapped Load

HELCO provided the day minimum loads and the loads were adjusted by subtracting the DG that was on the circuit at the time of the reading. The adjusted day minimum load was summed for each transmission line and provides the total non-coincident load tapped off each transmission line. These loads are shown for the 69 kV and 34.5 kV lines in Table 28 and Table 29.

Table 28: 69 kV Lines That Have Tapped Loads

69 KV TRANSMISSION LINES DAY TIME MINIMUM LOADING ADJUSTMENT FOR PV, NON-COINCIDENT CIRCUITS TOTAL		
Line	Substation Unit and Size (OA/FA)	Total (kW)
6100	Komohana unit 1 (10.0/12.5 MVA), Komohana unit 2 (10.0/12.5 MVA)	5,025
6200	Hale Pohaku 1 (3.0 MVA), Hale Pohaku 2 (3.0 MVA), Pohakuloa (2.5 MVA), Waikii (1.5 MVA)	1,768
6300	Panaewa (10.0/12.5 MVA), Kulani (1.5 MVA)	3,280
6500	Kawailani (10.0/12.5 MVA), HPP (7.5 MVA), Kapoho (7.5 MVA)	6,223
6600	Punaluu (5.0 MVA), South Point (5.0 MVA)	790
6700	Keauhuholu (10.0/12.5 MVA)	883
6800	Huehue (10.0/12.5 MVA), Puuwaawaa (1.5 MVA), Puu Huluhulu (10.0/12.5 MVA)	2,702
7300	Lalamilo (10.0 MVA), Kawaihae (2.5 MVA), Waika (7.5 MVA)	3,565
7500	Keahole Airport (5.0 MVA), Host Park (7.5 MVA), Kaloko 1 (5.0/6.25 MVA), Kaloko 2 (10.0/12.5 MVA), Kealakehe (10.0 MVA), Palani (10.0/12.5 MVA)	7,746
7600	Kauhale (5.0 MVA), Waipunahina (2.5 MVA)	1,824
7700	Puukapu (5.0 MVA), Kamuela (10.0/12.5 MVA)	2,487
8100	Waikoloa (7.5/9.375 MVA)	2,317
8200	Waikoloa Well (10.0/12.5 MVA)	0
8600	Captain Cook (10.0/12.5 MVA), Keauhou (5.0/6.25 MVA)	4,462
8700	Ainaloa (10.0/12.5 MVA)	2,263
9500	Kuakini 1 (10.0/12.5 MVA), Kuakini 2 (10.0/12.5 MVA)	4,138
9600	Kapua (5.0/6.25 MVA)	1,020

Table 29: 34.5 kV Lines That Have Tapped Loads

RADIAL 34.5 KV TRANSMISSION LINES DAY TIME MINIMUM LOADING ADJUSTMENT FOR PV, NON-COINCIDENT CIRCUITS TOTAL		
Line	Substation Unit and Size (OA/FA)	Total (kW)
3100	Honomu (2.5 MVA), Hakalau (0.75 MVA), Papaaloe (0.58 MVA), Laupahoehoe (2.5 MVA), Ookala (1.5 MVA)	618
3200	Paauilo (1.5 MVA)	15
3300	HTCO H-Frame (0.10MVA), Maluu Ridge (5.0 MVA), Hawi (2.5/3.125 MVA), Halaula (2.5 MVA)	1,899
3401	Kurtistown (5.0 MVA), Mt. View (5.0 MVA)	1,614
3402	Namakani Paio (1.5 MVA), Volcano (1.0 MVA), Wright Rd. (2.0/2.3 MVA), Royal Hwn (2.5 MVA), Orchid Isle (1.5 MVA)	2,163
3700	Hawaiian Beaches (2.5 MVA)	303

All the distribution transformers for both the 34.5 and 69kV lines have delta connected primary connections. Also, EPS assumed that the loading of the substation(s) on a particular line were equally loaded for purposes of reviewing the protection. These 69 kV lines were reviewed first.

7.5.2 Transmission Protection

The 69 kV transmission line protection utilizes a POTT scheme using the relays shown in Table 30 for primary and secondary protection.

Table 30: 69KV Transmission Relay Protection for Lines with Tapped Load

HELCO 69 KV TRANSMISSION LINES WITH TAPPED LOAD Relay Protection						
Line	Station	Relay 1	Extra I/O	Relay 2	Extra I/O	Comments
6100	Kanoelehua Kaumana	SEL 421- SEL 421-	Yes Yes	SEL 311C SEL 311C	Yes Yes	External TT equipment; Relay 2, no 79
6200	Kaumana Keamuku	SEL221G SEL 221G	No No	SEL 311C SEL 311C	Yes Yes	External TT equipment
6300	Puna Kilauea	SEL421-2 SEL421-4	Yes Yes	SEL 311C SEL 311C	Yes Yes	External TT equipment; Relay 2, no 79
6500	Kaumana Pohoiki	SEL421-4 SEL421-4	Yes Yes	SEL 311C SEL 311C	Yes Yes	External TT equipment; Relay 2, no 79
6600	Kilauea Kamaoa	SEL421-2 SEL421-2	No Yes	SEL 311C SEL 311C	Yes No	Mirror Bits both relays; Relay 2, no 79
6700	Keahole Kahaluu	SEL421-4 SEL421-4	Yes Yes	SEL 311C SEL 311C	Yes Yes	External TT equipment; Relay 2, no 79
6800	Keahole Keamuku	SEL421-4 SEL421-4	Yes Yes	SEL 311C SEL 311C	Yes Yes	External TT equipment; Relay 2, no 79
7300	Waimea Ouli	SEL221G SEL 221G	No No	SEL 311C SEL 311C	Yes Yes	External TT equipment
7500	Keahole Kailua	SEL221G SEL 221G	No No	SEL 311C SEL 311C	Yes Yes	External TT equipment
7600	Pepeekeo Honokaa	SEL221G SEL 221G	No No	SEL 311C SEL 311C	Yes Yes	External TT equipment
7700	Haina Waimea	SEL321-1 SEL321-1	No No	SEL 311C SEL 311C	Yes Yes	Mirror Bits both relays, DTT BFR; Relay 2, no 79
8100	Keamuku Anaihoomaluu	SEL221G SEL 221G	No No	SEL 311C SEL 311C	Yes Yes	External TT equipment
8200	Anaehoomalu Mauna Lani	SEL221G SEL 221G	No No	SEL 311C SEL 311C	Yes Yes	External TT equipment
8600	Kealia Kahaluu	SEL421-4 SEL421-4	Yes Yes	SEL 311C SEL 311C	Yes Yes	External TT equipment; Relay 2, no 79
8700	Puna Pohoiki	SEL421-2 SEL421-4	Yes Yes	SEL 311C SEL 311C	Yes Yes	Mirror bits relay 1; mismatch relay 2
9500	Kailua Kahaluu	SEL221G SEL 221G	No No	SEL 311C SEL 311C	Yes Yes	External TT equipment
9600	Kealia Kamaoa	SEL421-2 SEL421-2	No Yes	SEL 311C SEL 311C	Yes No	Mirror Bits both relays; Relay 2, no 79

Also shown is the input/output (I/O) capability of the relay pairs showing if the relay was purchased with extra I/O. An I/O miss-match between the relay pairs will cause difficulties in implementing some of the recommendations that will be discussed later. Communication between the two stations is via various methods and the relays communicate using two different schemes. Table 31 has the details on communication between the relays, reclosing and sync-check.

Table 31: 69KV Protective Relay Communication, Reclosing and Synch Check

HELCO 69KV TRANSMISSION LINES WITH TAPPED LOAD											
Protective Relay Communication, Reclosing and Sync-check											
Line	Station	Relay 1					Relay 2				
		HELCO Number	POTT input PT1	POTT output KEY	25 Deg	79 No.	HELCO Number	POTT input PT1	POTT output KEY	25	79
6100	Kanoelehua Kaumana	3016	IN102	OUT103	20	1	2733	IN102	OUT103	20	1
		2999	IN102	OUT103	20	1	2730	IN102	OUT103	20	No
6200	Kaumana Keamuku	2375	MPT	MA2	20	1	2747	IN102	OUT103	20	1
		249	MPT	MA2	20	1	2719	IN102	OUT103	20	1
6300	Puna Kilauea	2951	IN102	OUT103	30	1	2658	IN102	OUT103	30	No
		3036	IN102	OUT103	20	1	2855	IN102	OUT104	30	No
6500	Kaumana Pohoiki	3011	IN102	OUT103	20	1	2733	IN102	OUT103	20	No
		2975	IN102	OUT103	20	1	2846	IN103	OUT103	20	No
6600	Kilauea Kamaoa	2844	RMB1A	TMB1A	30	1	2845	RMB1A	TMB1A	30	No
		2858	RMB1A	TMB1A	30	1	2858	RMB1A	TMB1A	30	No
6700	Keahole Kahaluu	2972	IN102	OUT103	20	1	2735	IN102	OUT103	20	No
		2973	IN102	OUT103	20	1	2739	IN102	OUT103	20	No
6800	Keahole Keamuku	2977	IN102	OUT103	20	1	2758	IN102	OUT103	20	No
		2979	IN102	OUT103	20	1	2713	IN102	OUT103	20	No
7300	Waimea Ouli	2109	MPT	MA2	20	1	2711	IN102	OUT103	20	1
		2105	MPT	MA2	20	1	2752	IN102	OUT103	20	1
7500	Keahole Kailua	2279	MPT	MA2	20	1	2736	IN102	OUT103	20	1
		2449	MPT	MA2	20	1	2743	IN102	OUT103	20	1
7600	Pepeekeo Honokaa	2099	MPT	MA2	20	1	2748	IN102	OUT103	20	1
		2103	MPT	MA2	20	1	2103	IN102	OUT103	20	1
7700	Haina Waimea	2682	RMB1	TMB1	30	1	2683	RMB1A	TMB1A	30	No
		2660	RMB1	TMB1	20	1	2722	RMB1A	TMB1A	30	No
8100	Keamuku Anaihoomaluu	2365	MPT	MA2	20	1	2714	IN102	OUT103	20	1
		2484	MPT	MA2	20	1	2723	IN102	OUT103	20	1
8200	Anaehoomaluu Mauna Lani	2472	MPT	MA2	20	1	2724	IN102	OUT103	20	1
		2098	MPT	MA2	20	1	2725	IN102	OUT103	20	1
8600	Kealia Kahaluu	3047	IN102	OUT103	30	1	2715	IN102	OUT103	30	No
		3052	IN102	OUT103	30	1	2741	IN102	OUT103	30	No
8700	Puna Pohoiki	2945	RMB1A	TMB1A	20	1	2850	IN102	OUT104	20	1
		2939	RMB1A	TMB1A	20	1	2847	RMB1A	TMB1A	20	1
9500	Kailua Kahaluu	2451	MPT	MA2	20	1	2742	IN102	OUT103	20	1
		2283	MPT	MA2	20	1	2740	IN102	OUT103	20	1
9600	Kealia Kamaoa	2842	RMB1A	TMB1A	30	1	2843	RMB1A	TMB1A	30	1
		2862	RMB1A	TMB1A	30	1	2863	RMB1A	TMB1A	30	No

Thirteen (13) of the lines utilize external transfer trip equipment. Four of the lines use mirror bits on either a single or two separate channels depending on the vintage. Both the primary and secondary relays combine to provide complete backup such that if one relay is not operable, complete functionality is maintained (with some exceptions that will be discussed later). Also depending on the vintage, the three phase voltage source is taken from the bus and normally comes from separate secondary windings. The synch potential is from the line PT. In the majority of the newer stations the three phase source comes from the line and the synch source is from the bus. There are some stations that have both configurations.

The settings of the relays in terms of protection are nearly identical. For tripping at both substations, the distance relay element uses immediate trip of zone 1 and zone 1 directional ground overcurrent element, zone 2 distance relay element time delayed and inverse time

overcurrent element time delay. The zone distance elements and the inverse time overcurrent elements are reversed for blocking. No direct trip logic is used for the transmission line protection. However, some lines may use remote direct trip for breaker failure protection.

The substations will have reverse power flow into the transmission and sub-transmission lines when the DG penetration levels go beyond the 100% of the minimum day loading. The 125% would be the worst case consideration. Reviewing the Table 28, there are two lines where the DG loading looks to be significant. These lines are the Keahole to Kailua (7500) switching stations and the Kaumana to Pohoiki (6500) switching stations lines that have six and three substation transformers respectively. Assuming that the contribution occurs at the day-minimum and the inverters are limited to 1.2 PU amps, then the maximum current flow into the 7500 and 6500 lines is 40.6 Amps and 32.6 Amps respectively. The 3 phase fault contribution from the distribution is relatively small and does not cause much under-reaching of the distance elements.

On the 7500 line, the worst case condition is for a fault near the Keahole bus. The Kailua terminal will be weak but still within the zone 2 elements reach. For a single line to ground fault, the ground contribution from Kailua is still large enough for the zone 2 ground overcurrent to pick up despite the addition of the DG. The fault contribution does not exceed any of the equipment ratings on the transmission system or any of the substation transformers.

The 6500 line does not suffer from having a weak source on either terminal of the line. The addition of the DG does not cause any issues on the transmission protection settings. Also the fault contribution does not exceed any of the equipment ratings on the transmission system or any of the substation transformers.

7.5.3 Transmission Islanding

Again, each transmission line with tapped distribution substation(s) is a possible island area. When the DG starts to cause reverse flow from the islanded area then, similar to the distribution system, temporary ground rise issues result. For SLG faults on the transmission line, the only source of detection for the faulted phase is through the either of the two 69 kV breakers. Prior to opening of the either breaker, the system is effectively grounded. Effective grounding occurs when $0 < X_0 / X_1 < 3$ and $0 < R_0 / X_1 < 1$.

Except for a few exceptions, during the fault, since none of the substation transformers provide for a zero sequence source nor do the substations provide sensing of the 69 kV voltage, there is no local capability for fault detection. There are some distribution substations that have 69kV PTs that are used for the Under Voltage Load Shedding (UVLS) protection in Kailua Kona area and the area around Ouli. The protection scheme was established because of probability of voltage collapse in these areas. These PTs can be used for measuring zero sequence voltage. During line to ground faults that result in islanding conditions, the faulted phase will have its voltage reduced to 0.0 pu L-G, and the non-faulted phases will experience full phase voltage due to the ground reference shift caused by the ungrounded 69 kV substation transformer(s). To avoid delayed fault clearing and to mitigate the risk of overvoltage conditions following islanding, EPS recommends that the existing distribution substation(s) as well as the PV facilities be directly tripped by the transmission line relays protecting the transmission line. The intent is to trip the significant DG source to re-establish an acceptable load to generation ratio above 2.0.

The direct transfer trip (DTT) need only come from one of the 69 kV line terminals. The transmission line relay pairs need to determine only if the following conditions exist to send a DTT as previously mentioned:

- Site 1 relay issues a trip to CB at site 1 and Site 2 relay issues a trip CB at site 2.

- Site 1 CB is open and Site 2 relay issues a trip to CB at site 2.
- Site 2 CB is open and Site 1 relay issues a trip to CB at site 1.
- Site 1 CB is open and Site 2 CB is open.

The communication between the relay pair should have mirror bits. The normal mirror bits channel has the spare points to be able to transfer the information over from the remote terminal. The existing relays can be used to determine the logical conditions for the DTT. Of the 17 69 kV transmission lines, only 4 of the lines utilize mirror bits. Of the 4 lines utilizing mirror bits, two of the lines have a mismatch between the relay pairs for extra I/O. Communication channel(s) can be established to the distribution substation(s) to provide either mirror bit communication to the protective relaying or contact replication.

The communication between at least one relay pair should be upgraded to MB when DTT is required. In addition, at least one relay on the 6600 and 9600 line should be changed with a relay that has the additional I/O. Then high speed DTT to the distribution substation(s) as required resulting in a load to generation ratio of 2.0.

Per ANSI standard C62.22, the arrestors on the transmission line should withstand approximately 1.55 times its MCOV rating for 0.7 seconds.

9600 Line Example

9600 Line - At Kamaoa the rating of the arrestor is 57 kV MCOV, meaning that the arrestor should be able to withstand 88.35 kV for 0.1 seconds. At Kealia the arrestors are Westinghouse IVS and are rated 73 kV per the drawing. The voltage rating for these types of arrestors designates the maximum applied line to ground voltage that the insulator is able to withstand and then restore itself as an insulator after being discharged. The Kapua substation transformer arrestor is rated 60 kV. The drawings do not indicate the make or rating and should be checked. The phase to ground voltages will rise to nominally 69 kV during a ground fault condition after the circuit is islanded by the opening of the 9600 line breakers. Therefore, the ground fault condition may slightly exceed the arrestor withstand ratings if there is a long time delay between the opening of the 9600 line breakers and the opening of the Kapua Substation circuit switcher.

Although the surge arrestor must withstand the temporary overvoltage following the opening of the HELCO breakers, the arrestors should not be rated to the full rating required for the overvoltage condition following the opening of the HELCO breakers, i.e. rated for use on an ungrounded system. Increasing the MCOV arrestor rating above 57 kV is not recommended due to insulation coordination requirements on the HELCO system. Since the overvoltage condition only occurs if the HELCO 9600 line is isolated from the HELCO system while generation is on at Kapua, arrestor changes within the islanded area are not recommended.

Arrestor Summary

The drawings provided do not provide a detailed listing of all the arrestors utilized on the system. Each substation that is tapped onto the 17 lines should have all the arrestor reviewed and identified. When transmission line reaches the minimum day load to DG level of 1.3 the arrestor should be upgraded to 57 kV MCOV.

7.5.4 Sub-Transmission Protection

Again, the six 34 kV sub-transmission lines are radial. The 34.5 kV lines between Pepeekeo to Honokaa (3100-3200 Line) as well as Puna to Kilauea (3400 Line) are normally open at one

point and radially served from either end but can be served from a single end during an abnormal condition. These two pairs of lines have protection issues.

3400 Line

The 34.5 kV line (3400) from Puna to Kilauea substation is 34.6 miles and has a normally open section from switch 3408 and 3409. The normally open section of the line is de-energized and is 5.7 miles. From Puna CB 3401 is a radial section of line that is 7.1 miles with two 5 MVA transformers. There are two relays a SEL-221G5 and a SEL-311C that provide 100% redundancy. The SEL-221G has two zones of phase step distance and directional ground overcurrent relay protection. The zone 1 reach of 120% and zone 2 is 248%. The zone 2 has a time delay of 33 cycles. The line is $Z_1 = 8.17 + j5.39$ ohms primary and this represents a line length of 7.07 miles. The secondary relay is a 311C and has two zones of phase distance, a single ground distance and two directional ground overcurrent relay protection. The zone 1 reach of 120% and zone 2 is 247% where the line is $Z_1 = 8.18 + j5.40$ ohms primary and this represents a line length of 7.07 miles. The 5MVA transformers have an impedance of approximately 19 ohms. Therefore the distance relays reach must be limited to avoiding reaching into the distribution circuit. The zone 2 reach is approximately 19 ohms so the reach does not go through the 5 MVA transformer. However, if there is an issue with the Kilauea circuit, such that the radial section coming from Kilauea 3402 must be served entirely by Puna 3401. The radial line section will now be 34.6 miles. The zone 2 reach from Puna is only 17.6 miles. This indicates that the remaining 16.9 miles would not be protected for non-ground related fault by the distance elements. HELCO used to be able to transfer load to allow sections of the 3400 line to be out of service. These settings may hinder that capability.

The Kilauea CB 3402 consists of a radial section of line with 5 substation transformers where the largest is 2.5 MVA. Like Puna, there are two relays a SEL-221G5 and a SEL-311C that provide 100% redundancy. The SEL-221G has two zones of phase step distance and directional ground overcurrent relay protection. The zone 1 reach of 100% and zone 2 is 120%. The zone 2 has a time delay of 60 cycles. The line is $Z_1 = 39.86 + j26.34$ ohms primary and this represents a line length is 34.6 miles which is the entire line. The normal configuration line length is 27.5 miles and $z_1 = 31.6 + j21.0$ ohms primary. Like Puna, the secondary relay is a 311C was set up the same to match the SEL 221G5. The 5MVA transformers have an impedance of approximately 19 ohms but are at the far end of the line. Therefore the distance relays reach must be limited to past the transformers secondary. The zone 2 reach is approximately 19 ohms so the reach does not go through the 5 MVA transformer.

3100-3200 Line

Similar to Puna 3401, Honokaa CB 3201 is a 6.99 mile line that uses the same setting concepts. The distance elements will not reach all the way to Pepeekeo. However, unlike the 3400 line, the largest transformer is Lapahoehoe (2.5 MVA) and is situated in the middle of the line which should allow the reach to extend for the entire line. For example, in the event that Pepeekeo CB 1938 needs to be taken out of service, then the relay settings at Honokaa would need to be updated to provide distance protection for the full length of the line.

3300 Line

The 3300 line emanates from Waimea switching station and has upgraded protection associated with the 10.5 MW HRD wind farm and utilizes mirror bits for DTT. Waimea CB 3301 has a SEL-321 relay as well as a SEL-311C relay. The switching station recently upgraded the ground source to a 69-34.5 kV, 5.0 MVA delta – grounded zig-zag transformer that operates in parallel with a 69-34.5 kV, 10.0 MVA grounded zig-zag – delta transformer. There are no protection issues with this line.

3700 Line

The 3700 line emanates from Puna switching station. Puna CB 3701 has a SEL-421-4 relay and a SEL-311C relay. There are no protection issues with this line.

13.8 kV Shipman-Kanoelehua

The Shipman 3 and 4 generators are ungrounded wye connected generators. Therefore the 13.8 kV system must remain effectively grounded. EPS understands that the Shipman grounding bank which was the GSU for retired unit 2 generator is no longer functional and disconnected pending removal. The only ground sources are located at Kanoelehua. There is a grounding bank connected to Kanoelehua Bus C. There is no information confirming that this ground bank is still in service but was included in the model. There are two other ground sources and these are a 7.5 MVA and a 10 MVA transformers that are both delta primary with grounded-wye secondary. Both of these transformers are connected to Kanoelehua Bus A.

Case E is a maximum generation case where all the Kanoelehua and Shipman generation is online. The maximum three phase fault levels at the Kanoelehua and Shipman bus are 18,913 Amps and 15,002 Amps respectively. The maximum single line to ground fault levels at Kanoelehua and Shipman are 18,402 Amps and 22,501 Amps respectively. The distribution fused cutouts should be reviewed for adequate clearing capability.

7.5.5 Sub-Transmission Islanding

Again, each sub-transmission line with tapped distribution substation is a possible island area. When the DG starts to cause reverse flow from the islanded area then similar to the distribution system, temporary ground rise issue result.

For SLG faults on the sub-transmission line, the only source of detection for the faulted phase is through the 34.5 kV breaker. Prior to opening of the breaker, the system is effectively grounded. Effective grounding is when $0 < X_0 / X_1 < 3$ and $0 < R_0 / X_1 < 1$.

During the fault, since none of the substation transformers provide for a zero sequence source nor the substations provide sensing of the 34.5 kV voltage, there is no local capability for fault detection. During line to ground faults that result in islanding conditions, the faulted phase will have its voltage reduced to 0.0 pu L-G, and the non-faulted phases will experience full phase voltage due to the ground reference shift caused by the ungrounded 34.5 kV substation transformer(s). To avoid delayed fault clearing and to mitigate the risk of overvoltage conditions following islanding, EPS recommends that the existing distribution substation as well as the PV facilities be directly tripped by the transmission line relays protecting the transmission line. The intent is to trip the significant DG source to re-establish an acceptable load to generation ratio.

The existing protection on the sub-transmission system has the capability to send the DTT. However, the difficulty is providing the communication to the distribution substations. When sub-transmission line reaches the minimum day load to DG ratio of 1.3, high speed communication to the distribution substation(s) is required for the DTT.

In the event of a load transfer for the 3100-3200 lines and the 3400 lines, the transfer of load needs to be reviewed to evaluate the load to generation ratio. In the event that the load being transferred can create a temporary overvoltage condition, then the DG must be disconnected during the transfer.

7.5.6 Reclosing and Synch-check

The HELCO 69 kV transmission lines utilize a single shot leader-follower breaker reclosing scheme when a line trips due to any type of fault. After the transmission line has tripped, the

designated leader breaker will close first to test the line once after an intentional time delay of 5 seconds. If the test is unsuccessful, then no further automatic closing is done. If the leader breaker is successful, the follower breaker will close assuming the sync-check permissive is satisfied. Each breaker can be either a leader or a follower as determined by the leader-follower switch position on the relay panel board.

The HELCO 34 kV sub-transmission system is radial and utilizes a single shot breaker reclosing with an intentional time delay of five seconds.

All closing of breakers on the 34 kV and 69 kV systems utilize synch-check relay as a permissive. The primary and backup protective relays may both provide sync-check for each breaker at each substation providing complete redundancy. The maximum line angle allowed for closing for most breakers is 20 degrees. However, there are a few lines on the system that are set for a maximum line angle of 30 degrees. The allowable voltage window is approximately +/- 10% from the nominal.

There are no issues with the existing HELCO reclosing practice due to the addition of DG.

7.6 Protection Conclusions and Recommendations

7.6.1 Distribution

- When the penetration level of the distribution circuit reaches the study penetration levels (generation to minimum day load expressed in percent) the following mitigation steps must be considered.
 - **50%** - The ratio of minimum day load to generation level is 2.0. At this level of generation there is the possibility of developing overvoltages due to the neutral shift for a line to ground voltage. At this point, a grounding bank is strongly suggested.
 - **75%** - The ratio of minimum day load to generation level is 1.3. At this level of generation there is a stronger possibility of developing overvoltages due to the neutral shift for a line to ground voltage. At this point, a grounding bank is required and DTT is suggested. The substation protective relays will need to be upgraded to microprocessor based protection for the DTT.
 - **100%** - The ratio of minimum day load to generation level is 1.0. At this level of generation there is more possibility of developing overvoltages due to the neutral shift for a line to ground voltage and possible the load rejection. At this point, both a grounding bank and DTT is required.
 - **125%** - The ratio of minimum day load to generation level is 0.8. At this level of generation there is a stronger possibility of developing overvoltages due to the neutral shift for a line to ground voltage. At this point, a grounding bank is required. The portion of DG that is causing the reverse flow must be cleared prior to opening the distribution circuit breaker. Another alternative is to never allow the reverse flow and to turn off the inverters that are causing the reverse flow until sufficient load is available to prevent the reverse flow.

Based on the mitigation steps there are more specific recommendations.

- The distribution circuits with high penetration levels should be reviewed prior to any load transfers and the transfers should be reviewed to determine the impact on the day minimum load to generation ratio. The analysis showed noticeable differences in the day-minimum load around Kahaluu substation, Kailua 11, Kamuela 11, Panaewa 11 and Mauna Lani 14 and these circuits should be reviewed.
- For economic reasons the sizing of the grounding bank should be as large as possible, but not so large as to decrease the ground current (3I_o) contribution from the substation by more than 5 to 7%. The 5 to 7% is a reasonable target without compromising the sensitivity of the residual ground overcurrent relay at the circuit breaker. Also, the grounding bank should be located close to the substation breaker for better coordination with downstream protection devices.
- A method for monitoring the health of the grounding bank should also be installed. If a grounding bank is not available, then the generation level should be reduced such that the ratio of the day-minimum load to connected DG is 2.0 or higher.
- EPS recommends the installation of either a SEL-351A or a SEL-651R to replace the 50/51 and reclosing relays at the substation distribution protection. The existing 50/51N relay should be kept for backup protection if possible. Also EPS recommends the installation of a SEL-751A at the DG facilities. When the distribution circuit breaker (could be a recloser) has been determined to be tripped or opened, a DTT is to be sent to the SEL-751A relay at the DG facilities. HELCO does use the SEL-651R which is also equivalent to the SEL-751A for this application. The SEL-751A will be programmed to issue an immediate trip to the project's inverters upon receipt of the DTT. EPS also suggests that a main breaker with trip and close capability be installed if the inverter does not have remote trip capability.
- A larger load to generation imbalance should be maintained to allow for future smaller DG additions that will not have the capabilities for DTT. For this reason, the pre-approved DG projects should be reviewed.
- As the DG penetration increases, the wye grounded – wye grounded distribution transformer provides numerous advantages over the other transformer configurations. The utility can establish an effective ground on the distribution circuit via a grounding bank of suitable size. The grounded wye – grounded wye provides a path for the zero sequence current between the primary and secondary connection. Even if the DG does not provide zero sequence current, grounded wye – grounded wye potential transformer can be installed so that zero sequence voltage can be measured to sense when there is a ground fault on the distribution circuit(s).
- The communication method for the DTT is dependent on the amount of DG on the distribution circuit. For area's with a higher number of DG installations that require DTT, EPS proposes that IEC 61850 protocol be used, using GOOSE on a "flat" LAN. The "flat" LAN works using the MAC address in lieu of a routable protocol. This method is easily scalable such that the DTT can be sent to future DG installations. The

recommended SEL relays are capable of using GOOSE and should be purchased with that option.

- For re-closing on the distribution, the intentional time delay for reclosing should be set over twice the IEEE-1547 islanding clearing requirement of two seconds. However, EPS recommends a dead-line check be established if faster re-close times are required or when the ratio of minimum day load to connected DG decreases to 1.0 or less.
- The distribution under-frequency relay (81U) should be supervised by the circuit's directional element on the feeder. Basically, if there is a system disturbance that triggers the 81U relay and directional element for the feeder is reversed indicating that the generation on the feeder exceeds the load, then the 81U relay element is disabled. However, if the DG does not exceed the load on the circuit, the feeder will trip.
- HELCO should periodically revisit the load shed setting scheme. The addition of the distributed generation will have an impact on the expected response of the load shed relays. The under-frequency load shedding scheme was designed with specific MW levels for the different stages. The addition of distributed generation can create scenarios in which the actual vs. expected tripped load are significantly different.

The following concerns were found that are not directly attributed to the addition of the DG during the review process of the distribution protection.

- The distribution circuit phase and residual ground pickup settings were reviewed based on suggested setting practice. There are possible areas for concern on longer distribution feeders that are fed from substations on the 34 kV system or are fed from substations in the South Point area. These are areas of the HELCO system that are weak. There are 16 circuits that should be reviewed to determine if mitigation is required.
- A sensitivity analysis was made for the residual ground overcurrent relay pickup settings using different fault resistances at the end of the main feeder. For this review, if the fault level fell below 160% of the pickup, then the tripping of the relay is questionable. The analysis showed that when the fault resistance increased above 25 ohms on the 7.5 and 10 MVA transformers' circuits, the fault levels fell below 160% of the relay pickup. The 69-12.47 kV, 5.0 MVA transformer grouping were more sensitive to the fault resistance as seen below:

Kapua 12 – 2.5 ohms or greater
Kealia 11 – 5.0 ohms or greater
Punaluu 11 – 10.0 ohms or greater
Punaluu 12 – 5.0 ohms or greater
Puukapu – 0.0 ohms or greater
South Point 12 – 10 ohms or greater

The 69-12.47 kV, 3.0 MVA and less transformer grouping showed better results than the 7.5 and 10 MVA group. Some of the circuits that come from substation transformers connected to the 34.5 kV system showed poor results. The following circuits also failed

to meet the 160% threshold: Kurtistown 11 and 12, Hawi 1 and 2, Ookala 11 and Pa'auilo 1 when the fault resistance was 10.0 ohms or greater.

- The number of cascaded fuses should be limited to no more than 3 levels. There is little economic or reliability justification for installing the 3 level of fusing. Also, using cascaded fuses of the same size should be avoided.
- Although the HELCO system does not have large fault currents on the distribution system, care should be taken to ensure coordination between cascaded fuses in the low ampere range.

7.6.2 Substation Transformers

- The addition of the DG does not cause any issues on the substation transformer protection or system overloads.
- For general protection practice not related to the addition of DG, HELCO should consider the following for substation transformers:
 - Strong consideration should be given to upgrading the protection on all 10 MVA transformers to include differential protection and a high side circuit switcher or Vac-rupter. The differential scheme should include the distribution bus in the zone of protection.
 - HELCO should consider including the 7.5 MVA transformers with the 10 MVA transformer class in terms of protection improvements.
- HELCO has standardized the primary substation transformer fuse size for larger transformers on the system. However, the smaller substation transformer still requires standardization.

7.6.3 Transmission

- The addition of the DG does not cause any issues on the transmission protection settings on the 17 transmission lines that have distribution substation transformers tapped from the line. Also the fault contribution does not exceed any of the equipment ratings on the transmission system or any of the substation transformers.
- When transmission line reaches the minimum day load to DG level of 1.3, the following upgrades are required where applicable:
 - Communication between at least one relay pair should be upgraded to MB when DTT is required for a transmission line.
 - At least one relay on the 6600 and 9600 line be changed with a relay that has the additional I/O.
 - High speed DTT to the distribution substation(s) as required resulting in a load to generation ratio of 2.0 or total removal of the generation.
 - The drawings provided do not provide a detailed listing of all the arrestors utilized on the system. Each substation that is tapped onto the 17 lines should have all the arrestor reviewed and identified. When transmission line reaches the minimum day load to DG level of 1.3 the arrestor should be upgraded to 57kV MCOV.

- There are no issues with the existing HELCO reclosing practice on either the transmission or sub-transmission system.
- The existing protection on the sub-transmission system has the capability to send the DTT. When sub-transmission line reaches the minimum day load to DG level of 1.3, high speed communication to the distribution substations is required for the DTT.
- In the event, of a load transfer for the 3100-3200 lines and the 3400 lines, the transfer of load needs to be reviewed to evaluate the load to generation ratio. If the load being transferred can create a temporary overvoltage condition, then the DG must be disconnected during the transfer.



Analysis of High-Penetration Levels of Photovoltaics into the Distribution Grid on Oahu, Hawaii

Detailed Analysis of HECO Feeder WF1

Dr. Emma Stewart, James MacPherson, and
Slavko Vasilic
BEW Engineering, A DNV Company
San Ramon, California

Dr. Dora Nakafuji and Thomas Aukai
Hawaiian Electric Company (HECO)
Honolulu, Hawaii

NREL Technical Monitor: Jamie Keller

NREL is a national laboratory of the U.S. Department of Energy, Office of Energy Efficiency & Renewable Energy, operated by the Alliance for Sustainable Energy, LLC.

Subcontract Report
NREL/SR-5500-54494
May 2013

Contract No. DE-AC36-08GO28308



Analysis of High-Penetration Levels of Photovoltaics into the Distribution Grid on Oahu, Hawaii

Detailed Analysis of HECO Feeder WF1

Dr. Emma Stewart, James MacPherson, and
Slavko Vasilic
BEW Engineering, A DNV Company
San Ramon, California

Dr. Dora Nakafuji and Thomas Aukai
Hawaiian Electric Company (HECO)
Honolulu, Hawaii

NREL Technical Monitor: Jamie Keller
Prepared under Subcontract No. LXL-040281-01

NREL is a national laboratory of the U.S. Department of Energy, Office of Energy
Efficiency & Renewable Energy, operated by the Alliance for Sustainable Energy, LLC.

National Renewable Energy Laboratory
15013 Denver West Parkway
Golden, Colorado 80401
303-275-3000 • www.nrel.gov

Subcontract Report
NREL/SR-5500-54494
May 2013

Contract No. DE-AC36-08GO28308

This publication received minimal editorial review at NREL.

NOTICE

This report was prepared as an account of work sponsored by an agency of the United States government. Neither the United States government nor any agency thereof, nor any of their employees, makes any warranty, express or implied, or assumes any legal liability or responsibility for the accuracy, completeness, or usefulness of any information, apparatus, product, or process disclosed, or represents that its use would not infringe privately owned rights. Reference herein to any specific commercial product, process, or service by trade name, trademark, manufacturer, or otherwise does not necessarily constitute or imply its endorsement, recommendation, or favoring by the United States government or any agency thereof. The views and opinions of authors expressed herein do not necessarily state or reflect those of the United States government or any agency thereof.

Available electronically at <http://www.osti.gov/bridge>

Available for a processing fee to U.S. Department of Energy
and its contractors, in paper, from:

U.S. Department of Energy
Office of Scientific and Technical Information
P.O. Box 62
Oak Ridge, TN 37831-0062
phone: 865.576.8401
fax: 865.576.5728
email: <mailto:reports@adonis.osti.gov>

Available for sale to the public, in paper, from:

U.S. Department of Commerce
National Technical Information Service
5285 Port Royal Road
Springfield, VA 22161
phone: 800.553.6847
fax: 703.605.6900
email: orders@ntis.fedworld.gov
online ordering: <http://www.ntis.gov/help/ordermethods.aspx>

Cover Photos: (left to right) PIX 16416, PIX 17423, PIX 16560, PIX 17613, PIX 17436, PIX 17721



Printed on paper containing at least 50% wastepaper, including 10% post consumer waste.

Authors

BEW Engineering, A DNV Company

Prepared By: Dr. Emma Stewart, Senior Engineer, Power Systems

James MacPherson, Engineer, Power Systems

Slavko Vasilic, Senior Engineer, Power Systems

Verified By: Billy Quach, Senior Engineer, Power Systems

Project Manager: Ron Davis, Director of Transmission and Distribution

Hawaii Electric Company (HECO)

Dr. Dora Nakafuji, Director of Renewable Energy Planning

Thomas Aukai, Renewable Energy Planning Engineer

Abstract

Renewable generation is growing at a rapid rate due to the incentives available and the aggressive renewable portfolio standard (RPS) targets implemented by state governments. Distributed generation in particular is seeing the fastest growth among renewable energy projects, and is directly related to the incentives. Hawaii has the highest electricity costs in the country due to the high percentage of oil burning steam generation, and therefore has some of the highest penetration of distributed PV in the nation. The High Penetration PV (HiP-PV) project on Oahu aims to understand the effects of high penetration PV on the distribution level, to identify penetration levels creating disturbances on the circuit, and to offer mitigating solutions based on model results. Power flow models are validated using data collected from solar resources and load monitors deployed throughout the circuit. Existing interconnection methods and standards such as IEEE 1547, Hawaii Rule 14H and California Rule 21 are evaluated in these emerging high penetration scenarios. A key finding is a shift in the level of detail to be considered and moving away from steady-state peak time analysis towards dynamic and time varying simulations. Each level of normal interconnection study is evaluated and enhanced to a new level of detail, allowing full understanding of each issue.

Acronyms

BEW	BEW Engineering
DG	Distributed Generation
HECO	Hawaii Electric Company
GIS	Geographical Information Systems
LTC	Load Tap Changer (located on Substation Transformer)
LDC	Line Drop Compensation (enabled on LTC normally)
NREL	National Renewable Energy Laboratory
OPS	Operations at HECO
PSLF	Transmission power flow simulation model developed by General Electric
PSS/E	Transmission power flow simulation model developed by Siemens
PV	Photovoltaic
RPS	Renewable Portfolio Standard
SCADA	Supervisory Control and Data Acquisition
SLACA	Substation Load and Capacity Analysis
SynerGEE	Electric– Distribution simulation model developed by GL-Group

Confidentiality Statement

This report was prepared by BEW Engineering, a subsidiary of Det Norske Veritas (DNV), as an account of work undertaken under the authorization of Hawaii Electric Company (HECO). Material in this report is considered confidential by BEW Engineering and HECO. No part of this report is to be released to any third party (outside of BEW and HECO), without express written permission from both HECO and BEW. However, it is assumed that, after approval from HECO, this document will be published as a subcontract report by the National Renewable Energy Laboratory (NREL).

Acknowledgements

This work is jointly funded under the DOE NREL Hi-Pen Initiative, California Public Utilities Commissions, California Solar Initiative RD&D project, with funds also provided by Sacramento Municipal Utilities District and Hawaiian Electric Company. The authors also gratefully acknowledge the contribution of Elaine Sison-Lebrilla of Sacramento Municipal Utilities District.

Contents

Authors.....	iii
Abstract.....	iii
Acronyms.....	iv
Confidentiality Statement.....	iv
Acknowledgements	iv
List of Figures	vi
List of Tables	vi
1 Introduction.....	1
1.1 Feeder Selection.....	2
1.2 Changing Perception of Technical Barriers to High Renewable Penetrations.....	2
2 Summarizing New Conditions for Interconnect Studies	3
3 Distribution Feeder Modeling.....	5
3.1 Analysis Assumptions.....	6
4 Selecting Analysis Focal Points from Measured Data.....	6
5 Load Flow and Voltage Trends	12
5.1 Steady State Voltage Trends on WF1	13
5.2 Thermal Limitations.....	14
5.3 Backfeed	15
6 Tap Changer Cycling.....	17
7 Protection and Short Circuit Analysis.....	20
8 Dynamic Studies.....	21
8.1 N-1 Dynamic Analysis.....	22
8.2 All PV Trip Conditions	24
8.3 Flicker Study	26
9 Conclusions and Future Work	31
9.1 Limitations Specific to WF1	31
9.2 Comparison to Normal Standards and Interconnect Processes.....	32
9.3 Types and Levels of Analysis Recommended Based on Feeder Study	33
9.4 Future Work.....	34
10 References	35

List of Figures

Figure 1: Simplified one-line diagram of W1 Substation, and WF1 Feeder	2
Figure 2: Feeder WF1 load and irradiance monitor locations	7
Figure 3: Change in tap position during week of April 16 - 21	9
Figure 4: Real power measurement week of April 16 - 21	9
Figure 5: 3 Individual & average irradiance sensor measurements April 17; average irradiance April 19.....	10
Figure 6: 3 Average irradiance sensor measurements April 1	10
Figure 7: Binning of tap changer counts for each month above a mean of 5	11
Figure 8: Number of events, of 1-second variability in irradiance measurement, plotted monthly .	12
Figure 9: Voltage trends in minimum daytime load conditions on WF1 with varying PV penetration levels.....	13
Figure 10: Load trend on feeder with and without PV at peak and maximum load	14
Figure 11: Minimum measured day, plotted with measured irradiance data and scaled for April 9 to show potential backfeed levels.....	16
Figure 12: Minimum measured day, with 1.6 MW of PV generating on April 9 results in backfeed in the middle of the day.....	17
Figure 13: Sunny and cloudy day for tap changer cycling analysis over 24 hours.....	18
Figure 14: Tap changer position movement with existing PV on a sunny and cloudy day on WF1	19
Figure 15: Tap changer position movement with 60% PV on a sunny and cloudy day on WF1	19
Figure 16: Tap changer position movement with 100% PV on a sunny and cloudy day on WF1	19
Figure 17: System frequency variation during an N-1 conventional generator trip with no PV (blue), Hi-PV on the WF1 Feeder only (red), and Hi-PV in the W1 area (green)	23
Figure 18: 12 kV bus voltage variation with no PV (blue), and Hi-PV on WF1 (red) during an N-1 conventional generator trip	23
Figure 19: 12 kV bus voltage variation with no PV (blue), Hi-PV on WF1 (red), and very Hi-PV on WF1 (green) during an all PV trip scenario such as an anti-islanding event	24
Figure 20: 12 kV bus voltage variation Hi-PV on WF1 (blue) and Hi-PV in W1 area (red) during an All PV trip scenario such as an anti-islanding event	25
Figure 21: 46 kV bus voltage variation Hi PV on WF1 (blue) and Hi-PV in W1 area (red) during an All PV trip scenario such as an anti-islanding event.....	26
Figure 22: Irradiance plots of two representative variable irradiance days across 5 sensors from the Airport irradiance grid for input to the flicker analysis.....	28
Figure 23: 12 kV bus voltage variation for the 5 highly variable irradiance days input to the dynamic inverter model connected to WF1	29
Figure 24: 12 kV bus voltage variation for the most variable voltage response	29
Figure 25: GE flicker curve [4]	30
Figure 26: Comparison of 12 kV bus voltage for an instantaneous power output drop and a variable irradiance change	30
Figure 27: Types of analysis and when to consider during the interconnect process	33

List of Tables

Table 1: Enhancements to the typical PV interconnect process completed for WF1	4
--	---

1 Introduction

The HiP-PV [1], implemented in June 2010, addresses common issues between the Sacramento Municipal Utility District (SMUD) and HECO. Both utilities adopted aggressive renewable energy targets with SMUD targeting 37% by 2020 and HECO targeting 40% by 2030 for the three Hawaiian utilities. In conjunction with HiP-PV, NREL funded a collaborative effort together with HECO and BEW Engineering (BEW). These studies aim to characterize impacts of high PV penetrations on different types of distribution feeders and improve future interconnection processes.

This report pertains to specific analysis on feeder WF1 that was selected because of the existing feeder PV penetration level, diversity of customer types, and available solar sensor locations [2]. Study of individual feeder impacts provides insight to the potential barriers and issues restricting higher PV penetrations across both the Hawaiian and Sacramento utility areas. Commonly followed distributed generation (DG) standards such as IEEE 1547 [3] and IEEE 519 [4] are open to interpretation through the interconnection process. In-depth feeder analysis helps standardize and clarify the detail of measured data and analysis required. Lessons learned to date include:

- Availability of measured data is key to fully understanding impacts and sustainable development
- Software integration is essential for maintaining and growing PV portfolios
- Utilities must prepare for high penetrations of variable resources
- Legacy or aging distribution equipment, such as load tap changers, are particularly impacted by variability of high PV penetrations
- Utilities must plan for upgrades and operational changes ahead of time, with informed and validated analysis
- All stakeholders (i.e., operations, transmission and distribution planning, government agencies and developers) must find common ground for continued sustainable development.

The traditional distribution system is designed to deliver power from generator to customer load, and therefore all the control and protection equipment on the system are designed to move generation from system to load. Now, local load centers can generate sufficient power to service the local needs.

Under feed-in-tariff (FIT) programs, eligible renewable energy projects can produce power to sell back to utilities. As more of the local, distributed generation is expected to come from variable, nondispatchable PV resources, utilities like HECO need to better plan contributions from nondispatchable local generation. Visibility and monitoring of these nondispatchable resources is an essential piece of the future planning process.

1.1 Feeder Selection

Feeder WF1 is selected for the first portion of the HECO/SMUD HiP-PV penetration study. WF1 has a mix of residential and commercial customers distributed along the length of the feeder, allowing a wide range of PV installation types to be investigated. At the time of selection, WF1 had the highest existing penetration of PV installed of more than 20% and has a high number of available sensor locations and GIS data available.

The WF1 12 kV feeder is connected to W1 transformer from the substation 46 kV line. Figure 1 shows a simplified one-line diagram of the circuit. The W1 area, used later in the analysis, is defined as the Substation, and all other distribution substations fed from the same 46 kV line.

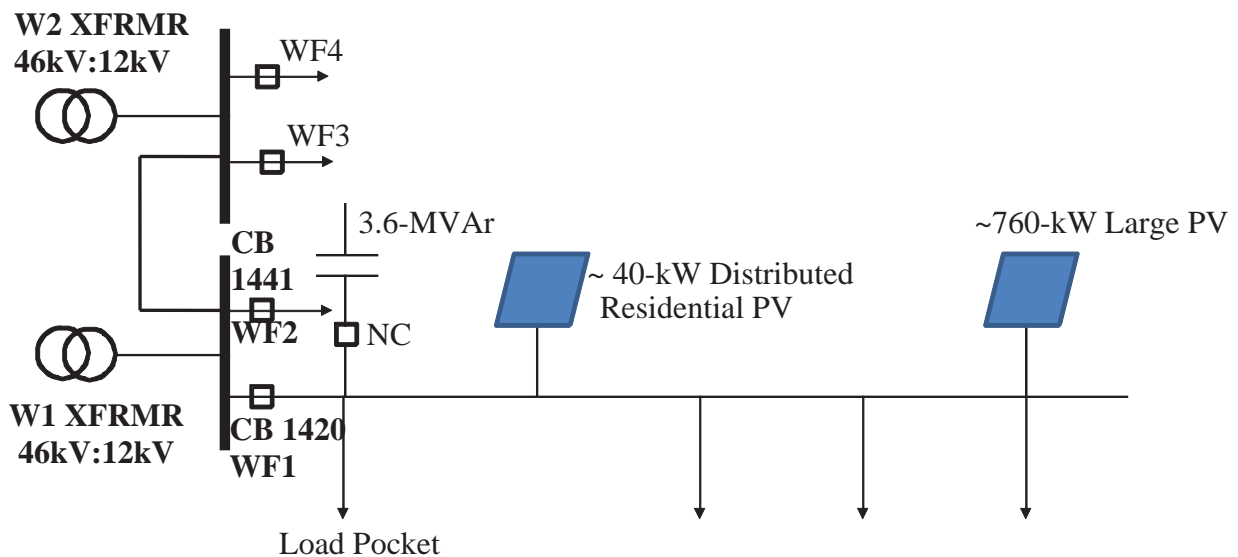

Figure 1: Simplified one-line diagram of W1 Substation, and WF1 Feeder

WF1 has 26% PV (of the feeder non-coincident peak demand) penetration, including 3 large PV locations at 500 kW, 218 kW, and 42 kW. Non-coincident peak demand indicates the single peak time for the feeder WF1 occurring at only one time during the year (originally selected as 2010 in this case). The non-coincident feeder peak does not always occur at the same time as system peak. There is a 3.6 MVar capacitor on WF1 located in the substation that is fixed and normally on. There are no line voltage regulators on WF1.

1.2 Changing Perception of Technical Barriers to High Renewable Penetrations

There are two approaches to using the distribution power flow simulation models and PV profiles. These are proactive and reactive. The proactive approach is the advanced study and planning of the distribution grid to determine where the potential problems could occur, the corrective action necessary, and the PV penetration level that creates the problem. The reactive approach is the study of each individual PV installation as it becomes commercial or into the queue.

As identified in recent federal stimulus proposals and projects being completed by BEW on high penetration impacts of PV on distribution systems [1], lack of observability (meaning ability to observe) and commercial tools to control high penetration of variable distributed generation are not only a Hawaii issue but a national concern. Individually, a residential-scale PV system does not impact system reliability. However, aggregated in large concentrations on a distribution circuit, these may pose reliability and protection concerns that warrant further investigation.

An example of the change in perception of interconnect requirements is voltage flicker caused by distributed generation. This change in analysis technique and perception is detailed in Section 8.3, described here as an example of the feeder results. Voltage flicker is widely discussed during System Impact Studies or Interconnection Studies by the control area operator or the electric utility. Misrepresentation of voltage flicker can often delay or create barriers for renewable energy projects' entry into the market. The simplest voltage flicker analysis for PV generation is based on perceived instantaneous irradiance dips of approximately 80% to 90%. These instantaneous post-transient simulations often do not account for transient stability of inverters and time varying generation output.

With emerging distributed PV resources, especially at high feeder and nodal penetration levels, the instantaneous power output methodology for flicker analysis may be too restrictive and an alternative approach such as using realistic, time series irradiance profiles may be needed to accurately capture PV impact. This is a future goal of the HiP-PV studies, as a single feeder analysis cannot quantify data collection goals for all feeders, but provides guidance for future studies to build on.

Hawaii Legislation Rule 14H and California Rule 21 define a 15% DG penetration level as a trigger for detailed interconnect studies. Historically, the 15% screen for PV penetration was selected based on probability of islanding. It was an administrative screen based on a 2 times safety factor with assumed 30% minimum load. Within the Hawaiian utilities, many distribution feeders exceed this 'rule of thumb' penetration filter. Utilities have limited observability to demand data at the distribution system level. If data is available, it is often on a longer time scale than required, such as 15 minute time steps versus 1 to 30 seconds. 15-minute increments of data can inform generation dispatch, but there is no visibility of irradiance fluctuations at this scale.

The HiP-PV project provides this observability through installation of high fidelity monitoring devices for both the distribution feeder load level and co-located irradiance measurement devices. The benefits of this are two-fold: (1) allow HECO to understand what data must be collected and at what fidelity to accurately quantify High PV impacts; and (2) allow validation of modeling techniques for future analyses.

2 Summarizing New Conditions for Interconnect Studies

Analysis is performed to a level of detail often not considered necessary in many interconnect areas. The table below indicates normally considered issues during HECO and other utility interconnect studies. The last column details the enhanced process considered in this analysis. Coloring of Table 1 items indicates importance, defined based on the single WF1 feeder analysis,

with red being most important or significant in future interconnect studies, orange of medium significance, and yellow least significant for future interconnect studies for WF1. Table 1 aims not to conclude on items of significance for all interconnect studies, but particularly for WF1 based on its particular characteristics at the time of analysis. Items identified as important to this analysis may not be important in all feeder studies, conversely items identified as not important could be identified as essential to a different feeder type of configuration. The HiP-PV study as a whole will aim to identify and categorize the impacts and significant analysis types across a range of feeder types. Each of these Analysis types could be treated as a gate or filter for PV penetration levels, once one analysis condition is satisfied, the next stage of analysis should be considered.

Table 1: Enhancements to the typical PV interconnect process completed for WF1

Analysis Type	Typical Detail Level	Enhancement	Color Code of Importance
STEADY STATE STUDIES			
Load Flow - Backfeed Potential	Peak Load Conditions Comment on equipment setting (LTC and LDC)	Minimum Daytime Load Investigate equipment settings and impact of changing Irradiance data for capacity vs. generated power	
Tap Changer Cycling	Step maximum output to minimum output at peak load, 1% limit in voltage change specified to impact LTC	Time sequential analysis with measured irradiance data over seconds and time delay of LTC Peak and Minimum Daytime Load conditions	
Protection/Short Circuit Study - Protection Coordination	Evaluation at POI for first screening (Rule 21/Rule 14 H), if does not pass screen detailed study include evaluation of the entire feeder	Impact of varied location, impact of changing size of inverter	
Load Flow - Thermal Loading	Peak Load Conditions	Minimum Daytime Load	
Load Flow - Voltage Profile	Peak Load Conditions Comment on equipment settings (LTC and LDC)	Minimum Daytime Load	
Load Flow - Losses	Peak Load Conditions With and without project	Minimum Daytime Load With and without a range of projects	

Protection/Short Circuit Study - Interrupt Rating	Evaluation at POI for screening, detailed study include evaluation of the entire feeder	Impact of different locations, increasing PV size and spread	
Harmonics	Only considered if source is present or specifically requested by Utility	Range of inverter types/conditions	
DYNAMIC STUDIES			
Dynamic/Stability Studies - All PV trip	Not normally completed	Multiple sites/nodal/cluster studies, PV is dynamic Inverter	
Dynamic/Stability Studies - N-1	Not normally completed	Full dynamic analysis on range of site sizes and configurations	
Dynamic/Stability Studies - Flicker	Instantaneous step change in output compared to IEEE 519 standards	1 second steps time sequential study with high-fidelity irradiance data input	

3 Distribution Feeder Modeling

A key to understanding the impacts of variable PV resources is accurately modeling the performance of solar PV systems in electrical distribution systems. The typical interconnect analytical processes used by developers and utilities are limited by the lack of detailed distribution modeling and data.

Interconnection studies typically use a three-phase model representation focusing on sub-transmission, transmission, and substation impacts. When single-phase modeling is available, such as at HECO, this information can be incorporated or delivered to the party completing the study. Interconnection studies often focus on a higher level representation of the entire electrical system often losing the granular details of individual feeder single phase counter parts. The distribution system is interpreted as an equivalent load, or simple impedance model. The highest level of existing detail is normally a three-phase aggregated load flow model. Impact of high penetrations of variable PV is not generally quantified, due to a lack of accurately measured irradiance data. An accurate aggregate model of distribution-connected PV is adequate for assessing system stability in dynamics, but inadequate for assessing local impacts on the distribution feeder.

For steady state analysis, all distribution features are included in an unbalanced model in SynerGEE Electric. SynerGEE Electric cannot model the inverter modules, or system, dynamically. Dynamic analysis requires converting the distribution grid to a balanced system. The single-phase inverters are aggregated to the three-phase feeder trunk. Single-phase and three-phase inverter characteristics remain modeled separately. As new inverter technologies are developed, these can be modeled separately from existing inverter representations.

PV inverters for the fault study are modeled in SynerGEE Electric using current limiters that limit fault to not more than the pre-set value of the rated current. The inverters are modeled as a

current source during a fault with a current rating at a range of 1.1 to 1.3 times the normal rated current of the PV inverter. In SynerGEE, the current source is created by using a feeder node for an ideal voltage source and a transformer impedance to convert to a current source. The magnitude of the current is a function of the transformer impedance, transformer kVA rating, and kV at the Point of Interconnection.

In dynamic studies, it is essential to represent the characteristics of all components deemed contributors to dynamic response, including PV inverters. In PSLF, the WF1 inverters are represented using a combination of standard dynamic generator models and user-developed models to represent specific control functions. The basic generator representation of a PV unit is replaced with the generic inverter- PV generator combination. Three separate PSLF models are required to accurately model one PV unit regardless of size or phase configuration, as shown below:

- gewtg (standard PSLF model)
- ewtgfc (standard PSLF model)
- epcmod (user-defined PSLF model).

3.1 Analysis Assumptions

The steady state and dynamic study assumptions include:

- IEEE standards [3] state the inverter shall not control voltage at the point of interconnection therefore not considered throughout this analysis. Voltage is regulated by tap changers and capacitors
- Low voltage (customer supply side) is not modeled
- Highly distributed potential PV does not exceed the size of the distribution transformer at any particular load point
- PV generation cannot exceed the maximum line rating of this feeder
- Under and over frequency settings, and under/over voltage protection is set in the dynamic inverter model according to IEEE 1547 limits [3]
- Normal practice or indicators of problems for equipment, such as mean number of tap changer operations for a 24-hour period, are defined by historical information and monitored performance of equipment.

4 Selecting Analysis Focal Points from Measured Data

Previous to this analysis, there has been little collection and correlation of power monitor and irradiance data, particularly to the high fidelity considered here. Two types of data are collected from the W1 area; (1) high fidelity load monitor data from the W1 substation and a small amount (3 days) of high fidelity data from one large customer location; and (2) high-fidelity irradiance data from three locations on or nearby WF1. All data is time stamped and synchronized using

global positioning system (GPS) devices. Two groups of issues are selected for enhanced analysis based on the measured data:

1. Variability impacts on voltage regulation equipment
2. Load reduction and backfeed impacts.

The aim of high-fidelity data collection is to conduct further analysis on the impacts of high penetrations of PV on this feeder with a validated model. Irradiance and Power Monitor Data from W1 substation is collected from December 2010 to June 2011. Data continues to be collected up to the date of this report. Three days of data from the load side of the transformer at Large Customer 1 is collected. The aim of the data collection is to:

- Decouple effects of normal daily load patterns and PV generation impacts using measured data
- Validate feeder models
- Determine required data fidelity for investigating PV variability impacts on the distribution grid.

The monitored power locations, irradiance locations and existing PV locations are detailed below (Figure 2).

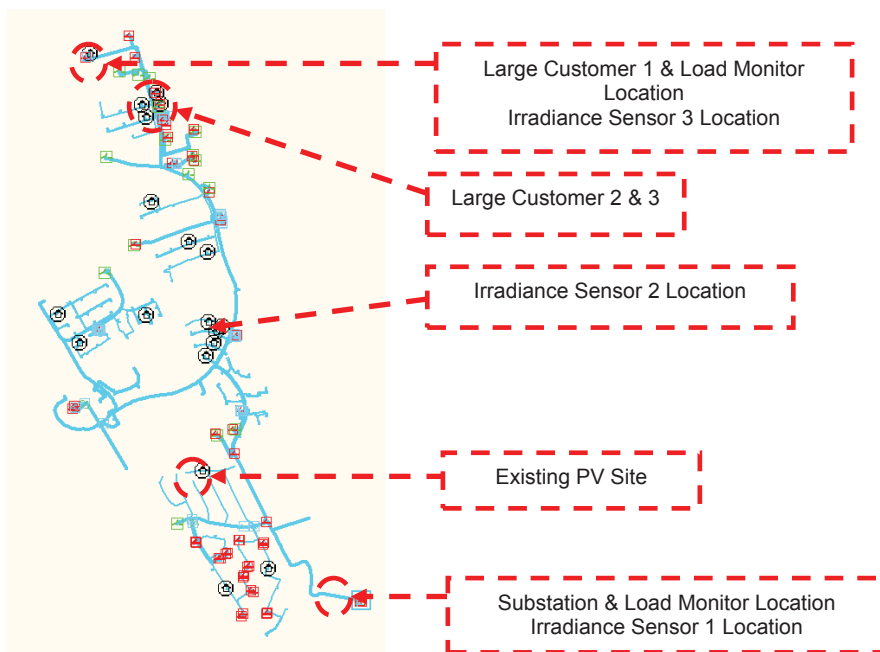

Figure 2: Feeder WF1 load and irradiance monitor locations

Model validation is performed initially to determine how accurate distribution models must be or currently are. The feeder load flow is validated over multiple time periods against voltage, current and tap changer positions. Errors are defined to be within 5% accuracy and this is deemed a successful validation. Accuracy standards for modeling are consistent with HECO

design tolerances and standard industry practice (based on IEEE standards for transformer design tolerance) [5].

The interaction and coordination between LTC, capacitor, and inverter operations for increased PV penetration and varying operational scenarios are a concern of many system operators, but are not normally considered part of the interconnection study. This issue is generally not a problem for single distribution sites, but when a large cluster or node of sites experiences highly variable cloud cover, there could be increased tap changer operations and inverter tripping. The voltage and frequency impact of inverter tripping (anti-islanding for example) is therefore considered part of the enhanced dynamic analysis.

From the six months of measured data, ‘interesting’ days are selected where operation is deemed to be different from the perceived normal. For example, the mean number of tap changer operations greater than five is considered unusual (HECO operations definition); therefore all days with a count greater are extracted and compared to irradiance data and other operational information to determine the cause. Two primary reasons are considered for increased tap changer operations: Either PV irradiance variability or a utility feeder switching action. Without detailed measured plant output, the conclusions are not definitive, but a comparison of tap changer operations is presented and variable irradiance is identified as a preliminary reason for the increase.

Items defined as interesting from the measured data are:

- High voltage at the transformer
- Unbalanced voltages (+/- 3% [6])
- Large numbers of tap change operations (above mean)
- Rapid changes in power
- Other outstanding days.

Tap position during a week in April is presented below (Figure 3), during which unusual numbers of tap change operations are recorded.

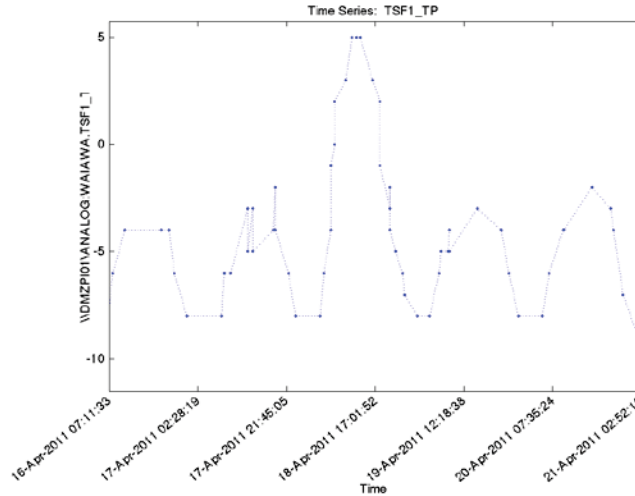

Figure 3: Change in tap position during week of April 16 - 21

Particularly on the 17th, 18th and 19th of April, there were more than 11 LTC operations. To determine the cause, these days are extracted and plotted from the power monitor data (Figure 4).

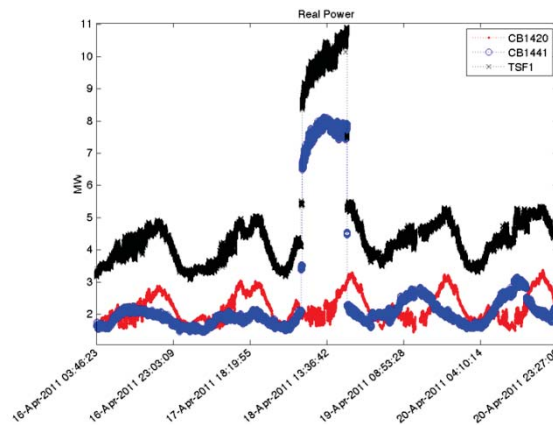

Figure 4: Real power measurement week of April 16 - 21

On the 18th of April, there is a significant increase in demand on both Feeder W2 and Transformer W1, indicative of a feeder switching operation. From the 6 months of data collected, the switching event occurs approximately once a month, indicating a switching study, N-1 conditions and an anti-islanding trip simulation should be considered as part of normal interconnect studies on this feeder. This type of load change event was verified with HECO to be caused by switching load onto the transformer from another feeder. On the 17th and 19th of April, there is no switching indicated in the load data to cause the large number of changes. The irradiance data is considered on these days [1].

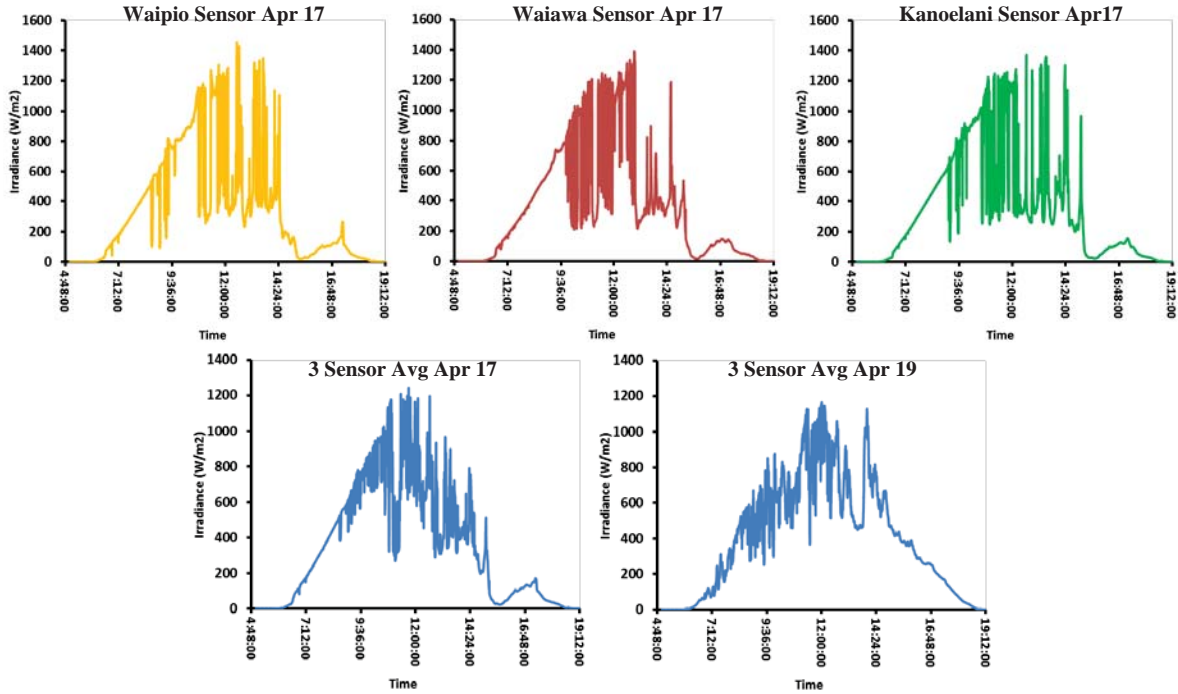

Figure 5: 3 Individual & average irradiance sensor measurements April 17; average irradiance April 19

The days shown in Figure 5 had particularly variable irradiance during midday hours, with a maximum ramp rate of 400 W/m²s. A less variable comparison is shown now. On April 1 there are 5 tap change operations. The irradiance on this day varied at a maximum of 200 W/m²s during off peak generation hours (10:00 a.m.). The impact of the variability on the system is also more significant when generation is greater, such as during midday hours. The irradiance for April 1 is shown in Figure 6.

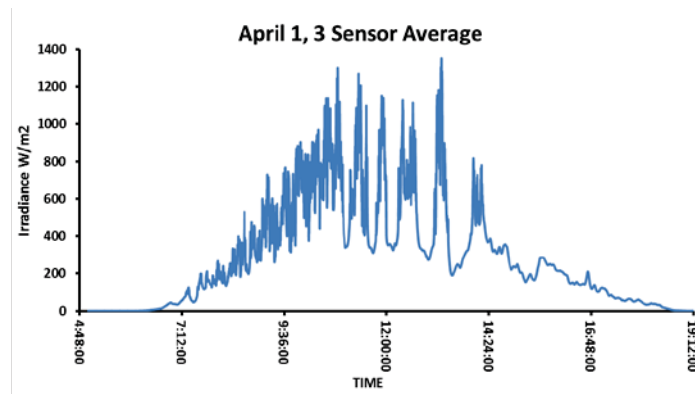

Figure 6: 3 Average irradiance sensor measurements April 1

While the irradiance and load monitor is not conclusive as to the cause of the tap changer cycling, it is a basic first step to determine the cause and should be developed further in future Hi-PV studies. To conclude further on the change in tap positions over the first 6 months of 2011, the count of operations is binned for each count, up to 11 changes, and classified by percentage of the month that had these changes (Figure 7). April is traditionally a variable

month, and the irradiance data has also shown this to be true. This is reflected in the tap changer count information, as April is generally above mean for tap position changes.

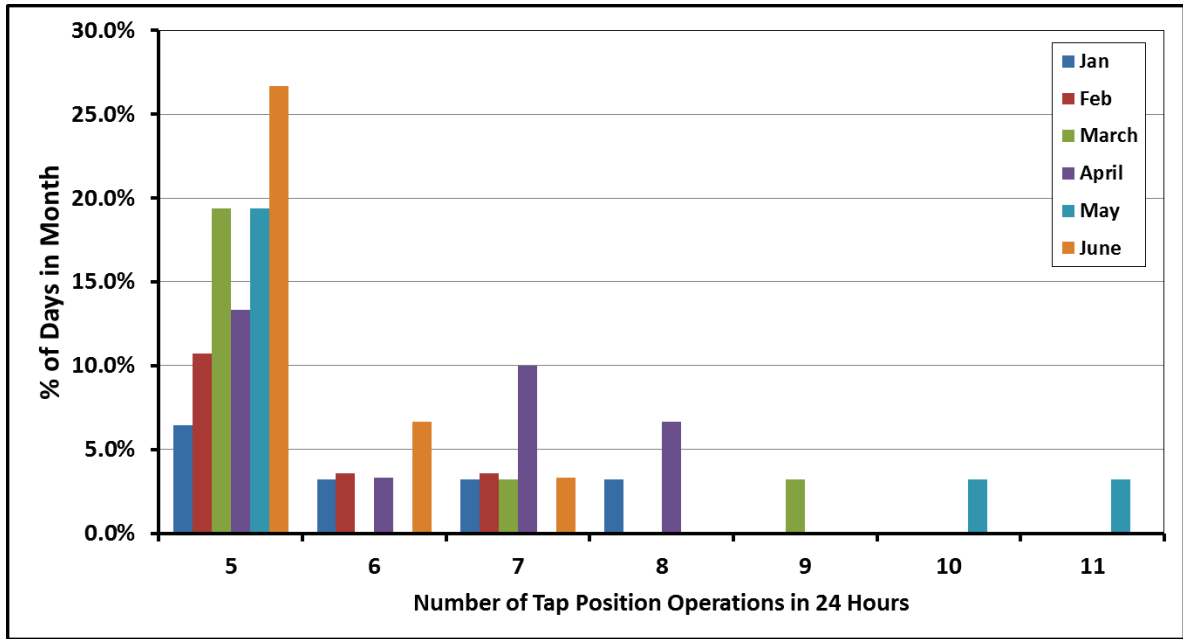

Figure 7: Binning of tap changer counts for each month above a mean of 5

The tap changer count indicates that April and May have particularly high numbers of tap changer operations above the mean. This is finally compared to the monthly variance (Figure 8), i.e., number of ramp events of each size (100 W/m²s up to 1000 W/m²s) per second for the entire year to determine how variable these months are in comparison to the rest of the year.

Both May and April have variances on the outer edge of the variance curve indicating these exhibit higher ramp rates more commonly than the other ten months. This again validates tap changer cycling, combined with irradiance data and therefore PV plant output should be considered a part of the new interconnect studies.

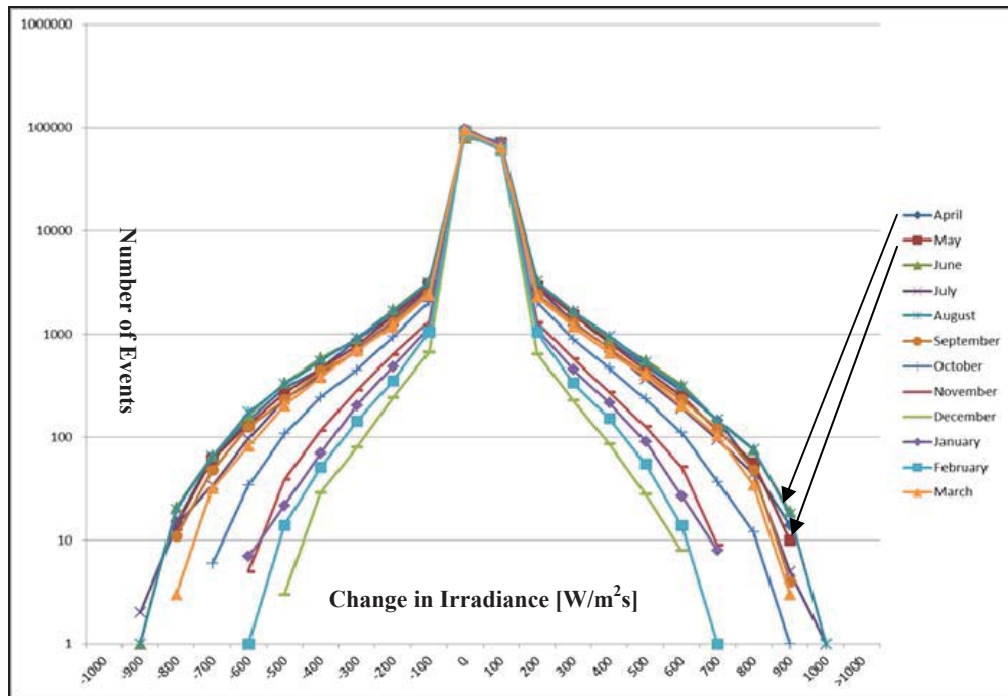

Figure 8: Number of events, of 1-second variability in irradiance measurement, plotted monthly

Figure 8 is for irradiance variation of the Waiawa sensor only. Considering the average of the three sensors in this area (Waiawa, Waipio, and Kapeolani) gives a smaller spread of ramp rates across time, but maximum variability in April and May is still observed.

5 Load Flow and Voltage Trends

Thermal loading of a feeder is always considered during the initial phase of standard interconnection studies, but the issue is also highly dependent on location of the PV. Voltage trends are normally considered with a single site installed. Unless this site is greater than the total load on the feeder section, or total feeder capacity, a voltage rise or drop is unlikely, but nonetheless must be considered during interconnect. Multiple PV sites on one feeder may combine to cause voltage issues. Voltage rise can cause equipment damage and protection malfunctions. Utilities consider voltage 5% above nominal a violation. There are two steady state load flow options conducted in this analysis. First, a single point in time load flow, either peak feeder demand time July at 3:00 p.m. or minimum feeder daytime demand time April at noon is considered. These days were selected from the measured demand data at the substation to represent the peak and minimum feeder load times. Variable resources are considered following the steady state analysis. Losses were deemed to be a minimal impact of PV on this feeder through simulation, particularly due to its short length and large capacity.

5.1 Steady State Voltage Trends on WF1

Steady state voltage trend or rise impacts were not observed in measured or simulated data on WF1. WF1 has larger conductors than a traditional distribution feeder, and therefore steady state voltage impacts are minimal. Longer feeders with alternate load profiles should be considered in future analyses. The voltage trend analysis does show interesting impacts of the interaction of line drop compensation at the transformer and increasing levels of DG. While steady state impacts on voltage are not observed, for the conditions analyzed, this is the first steady state filter or limit to penetration to be considered. Voltage impacts must be analyzed in both steady state and dynamic fields before a conclusion can be defined.

A distinction between non-backfeeding and backfeeding scenarios can be inferred from Figure 9. The non-backfeeding scenarios (green and red) show a decreasing voltage trend moving away from the substation, depicting the voltage drops of the normal condition of load being served by the feeder source. The backfeeding scenarios (blue and pink) show an increasing voltage trend, depicting current flowing from the distributed PV back to the feeder source. Voltage is increasing from the end of the feeder to the normal source. The PV generation is now providing real power to most, or all of the load.

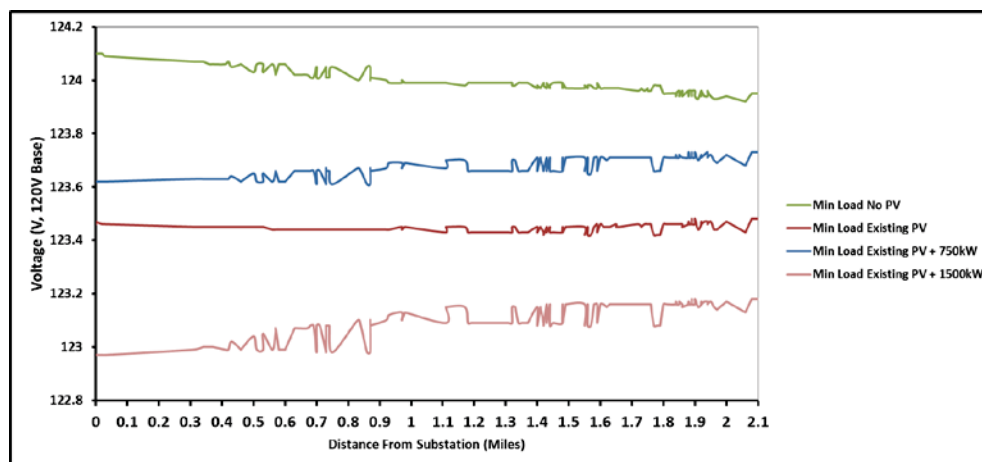

Figure 9: Voltage trends in minimum daytime load conditions on WF1 with varying PV penetration levels

The peak load case shows a more consistent trend — the voltage profiles continually decrease as more PV capacity is added. What is not shown is that this trend is maintained because the LTC tap position decreases each time additional PV is added. Only a small amount of backfeeding occurs for the Central 1500 kW case (light blue), and the voltage profile for this case is mostly flat. Distribution feeders are commonly sized with the largest conductor at the substation, decreasing in capacity to the end of the line. WF1 has large conductors throughout and capacity does not decrease along the line. Steady state voltage impact on WF1, is only the first voltage impact that should be considered in a detailed evaluation. Dynamic voltage impacts must be considered and are described in Section 8 of this report.

5.2 Thermal Limitations

A thermal limitation on a line or feeder is defined as loading above 100% of normal capacity. The limitation for PV on WF1 would therefore be if a site or combination of sites causes the line loading to exceed 100%. The WF1 line and transformer have capacities to carry load well above the current normal feeder customer load. As the potential PV does not exceed load at any point, there is little thermal limitation to well above 100% capacity of PV. Future analyses must consider a heavier loaded, closer to design tolerances feeder to accurately quantify this impact over multiple feeder types. Two extreme loading cases for WF1 are represented in Figure 10.

The case of maximum existing load (feeder non-coincident peak) with no PV generation is represented by the yellow columns ("Max Load No PV" case), and the case of minimum load with a high PV penetration (over 50%) is represented by the red columns ("Min Load + PV" case). The percent loading of conductors along the feeder are represented in the bar graph, and the magnitude of current flow is represented in the line graph. The Min Load + PV case has the existing PV plus the addition of 1.5 MW of PV at a central location, for a total of 2.3 MW PV generation capacity.

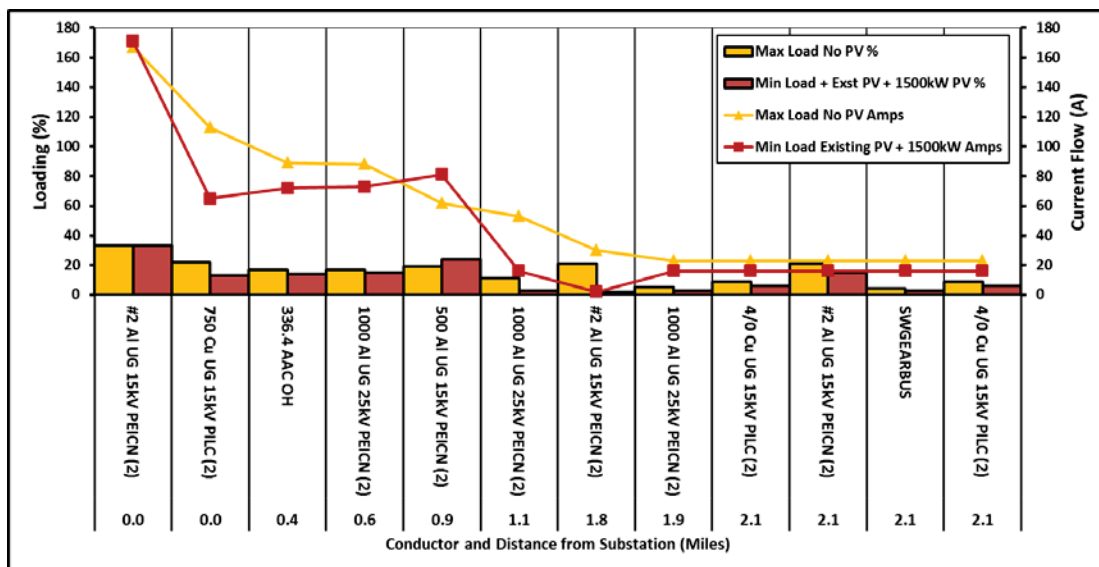

Figure 10: Load trend on feeder with and without PV at peak and maximum load

The loading of the conductors and the magnitude current flow are very similar for both the "Max Load No PV" case and the "Min Load + PV" case. The difference is the direction of current flow as the flow is reversed for the Min Load + PV case. Even for these extreme yet realistic loading scenarios, the maximum loading on W1 (discounting the capacitor section at 60%) is between 2% and 25%. This occurs because the conductors are oversized relative to the peak load on the feeder. Very different results may be seen when studying the effect of high PV penetrations on peak and minimum loading scenarios for different feeders.

Load flow analyses indicate minimum load conditions and line drop compensation (LDC) must be briefly considered during the interconnect studies at a single site, node, and cluster level. The

conditions causing overload, voltage rise or drop and change in losses are highly dependent on PV site location on the feeder. WF1 can support a high PV volume before a voltage or thermal impact would occur.

5.3 Backfeed

A third group of load flow issues to be considered in this analysis, extracted from the measured power monitor data, is using minimum daytime load conditions for analysis along with noncoincident daytime peak. This is not considered part of a normal interconnect per rule 14H, but may be considered during a HECO Interconnection Requirements Study.

Distribution feeders are traditionally not designed to carry bidirectional power flow, and therefore a number of issues can arise when distributed generation causes reverse flow through the substation transformer. Backfeeding occurs when PV generation on the feeder exceeds feeder demand and feeder losses. This can occur at current levels of PV penetration during periods of high PV generation and low load. As PV penetration levels increase, there is risk of backfeeding occurring more often at higher loading levels.

W1 transformer uses a legacy analog tap changer control system with LDC enabled. Most analog tap changer control systems cannot sense reverse current flow. Ideally in the event of backfeed, the line drop compensation portion of the line tap changer will turn off. Without the capability to sense reverse current flow, the LTC will continue to regulate the 12 kV, resulting in voltage violations from incorrect measured current. Line drop compensation effectively moves the point of feeder regulation based on the setting. It is used where there is significant voltage drop along the length of a feeder so that the end of the feeder does not experience unacceptable steady state voltage under high loading conditions. The limit for backfeed is therefore defined in this case on the basis that backfeed is physically possible yet undesired at the substation.

Line drop compensation levels out voltages in different load conditions, but can exacerbate voltage impact when combined with other regulation equipment or high penetrations of PV. It therefore must be considered a key part of the analysis and all data on this control system should be collected in future studies. All available load measured data at the substation is analyzed to find the minimum daytime load period, Saturday April 9th.

On Saturday April 9th there was approximately 800 kW of PV installed on WF1. The measured substation and feeder demand does not account for this existing generation and is therefore the net demand. The actual gross load is unknown on WF1 at the time of analysis. To accurately quantify the minimum daytime gross load on the feeder, irradiance data for the three local sensors is extracted, plotted with the minimum daytime load, and extrapolated to find the minimum daytime gross demand level on this day (Figure 11).

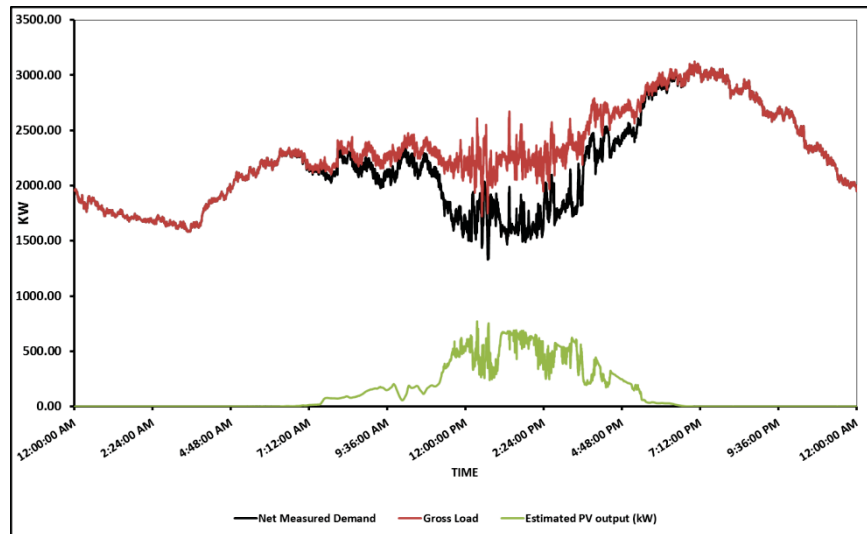

Figure 11: Minimum measured day, plotted with measured irradiance data and scaled for April 9 to show potential backfeed levels

The minimum measured daytime net demand on WF1, occurred at approximately noon and is 1.3 MW. With the addition of estimated PV output at that time, the minimum daytime gross load is 1.6 MW. 1.6 MW is 50% of the noncoincident peak demand on WF1 (3.2 MW).

While measured data is used to define the minimum day here for WF1, this daytime minimum is higher than would be considered. Data at the substation should be collected for a longer time period to accurately quantify minimum system, substation and feeder demand. The measured minimum also is a net measurement, meaning the PV generation that exists at that point in time is not accounted for in the measured data. To accurately define the load on the feeder, generation must be added to net load for the 24-hour period. Backfeed occurs when distributed generation is greater than the load and losses on the feeder at any particular time. Approximately 1.6 MW total (0.8 MW existing + 0.8 MW new) of PV generation on this particular day would result in a backfeed condition at the WF1 substation. This is shown in Figure 12.

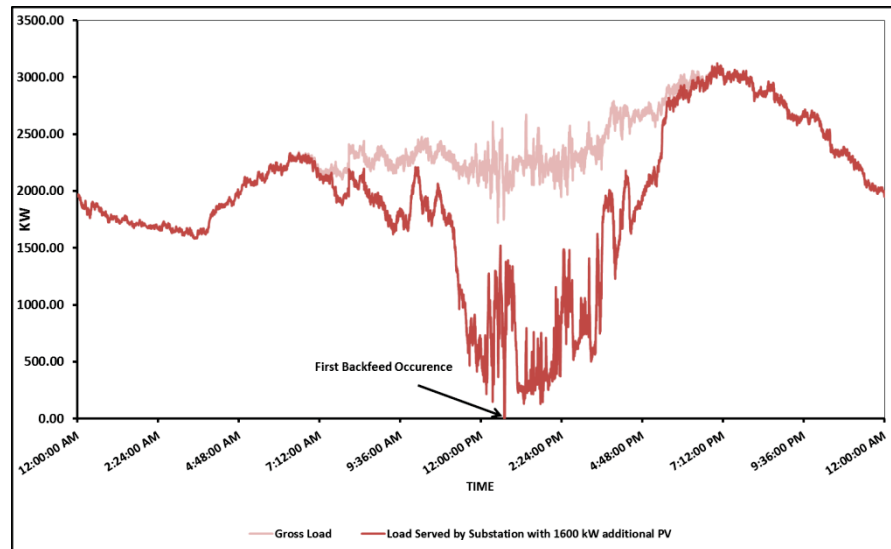

Figure 12: Minimum measured day, with 1.6 MW of PV generating on April 9 results in backfeed in the middle of the day

At approximately 12:30 p.m. in Figure 12, there is 10 minutes of backfeed from WF1 to the substation. As previously discussed, the substation transformer has a legacy analog line tap changer control system that is not equipped to sense reverse current flow and alter its regulation based on this. Further data should be measured for the substation and feeder load over a number of years to accurately quantify this minimum level. In rule 21 and 14H a 2 times safety factor is assumed for backfeed potential, i.e. with an assumed minimum daytime load of 30%, 15% of PV penetration triggers a detailed study. Applying that same methodology to this feeder, based on the minimum daytime load, 25% of PV penetration should be the first trigger for a detailed interconnect study.

Operation of the LDC should be examined for each future three-phase PV location on the feeder, as each time the voltage profile changes, the settings must be updated to account for this change. As current flow reverses through the transformer, the bi-directional aspect or abilities of the LDC must be disabled. The existing tap changer control cannot sense reverse power flow, and incorrect regulation will occur on the 12 kV feeder with incorrect LDC settings. This could result in reverse regulation of voltages on the distribution feeder and could adversely affect voltage regulation upstream on the sub-transmission level.

6 Tap Changer Cycling

Tap changer cycling is defined as the transformer tap position increasing or decreasing a number of times, greater than the normal mean number of operations. Normal analysis will consider the voltage change at point of interconnection being representative of how the tap changer will operate. The full on or full off condition is not representative of normal PV operation, but is a continuous variation throughout the daytime period based on irradiance fluctuations. Steady state and dynamic analysis can fully quantify if the on/off behavior is representative, or variation throughout the day should be considered. The load reduction during daytime periods and

therefore increased ramp up and down of power supplied by the substation transformer is also considered.

Tap changers alter the voltage at the substation source to the feeder depending on a measured value of voltage. The W1 transformer on average performs 5 operations a day. If the number increases by 1 or 2 operations based solely on PV operation, this analysis considers it a limiting factor for PV installation. Operations and measured evidence have recently shown that this tap changer is now operating more frequently as the PV levels increase. Effects of tap changer cycling can result in life reduction for the transformer, localized heating and wear on the tap changer parts. While the lifetime of the particular tap changer is not analyzed in this study, if a 2 position increase was seen throughout the year this represents a 40% increase in operation times (above mean). Lifetime of mechanical equipment, including tap changers, is defined based on number of operations. A 40% to 50% decrease in time taken to reach this limitation is therefore considered a major impact for WF1. This analysis and comparison to measured data enables a greater understanding of these impacts on a steady state and dynamic level. Switching impacts are decoupled from irradiance fluctuations. Short-term and long-term impacts are validated using the steady state SynerGEE model of WF1. Future impacts can now be determined as PV generation increases and the results extrapolated to quantify lifetime reduction.

A clear or sunny 24-hour period and a cloudy day are now considered. In these scenarios, typical load profiles are plotted. The 24-hour load profile is the same for each day; only the generator output changes. A comparison of the profiles is shown below. This data is input into SynerGEE Electric and a time sequential tap changer study is completed. Three penetrations are considered, Existing (26%), 60% and 100% PV.

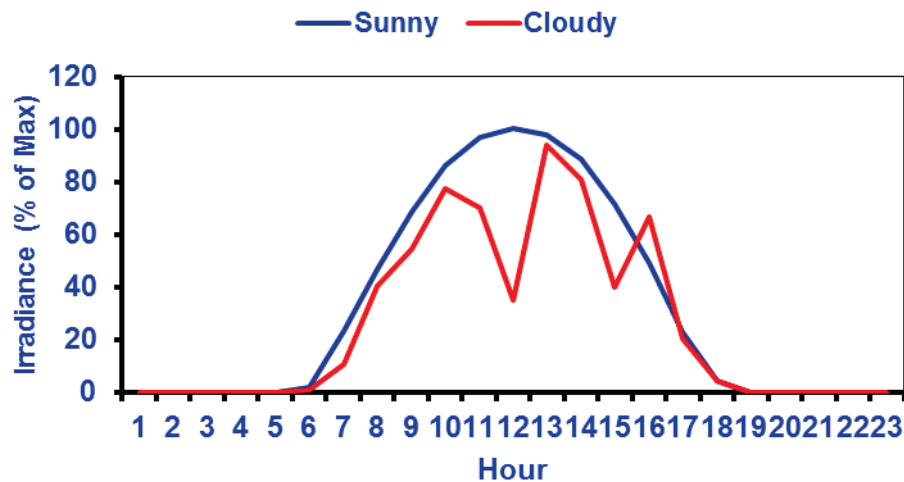

Figure 13: Sunny and cloudy day for tap changer cycling analysis over 24 hours

First, the sunny day and cloudy day on WF1 for only the existing PV over the 24-hour period is evaluated as shown below.

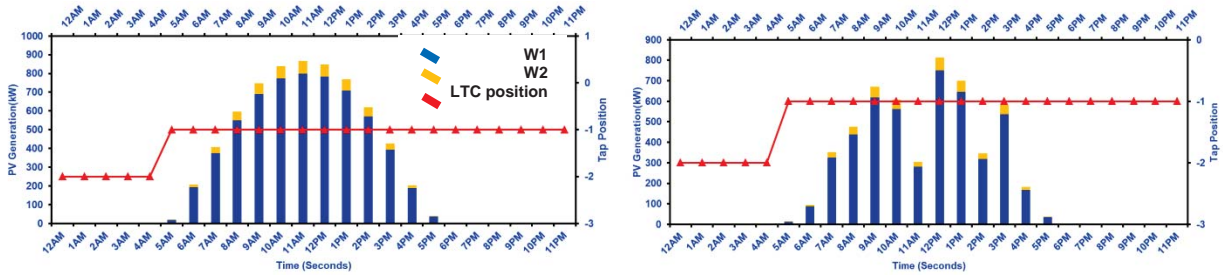

Figure 14: Tap changer position movement with existing PV on a sunny and cloudy day on WF1

The second scenario considers a clear and cloudy day with 60% of peak potential PV.

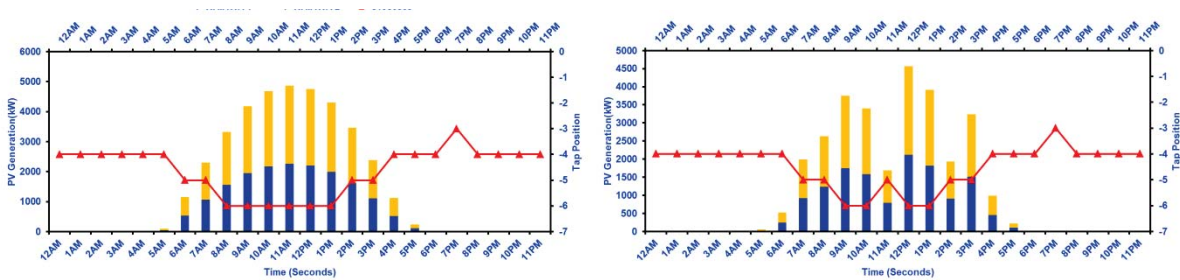

Figure 15: Tap changer position movement with 60% PV on a sunny and cloudy day on WF1

Finally, the 100% PV penetration and a cloudy and sunny day on WF1 is evaluated.

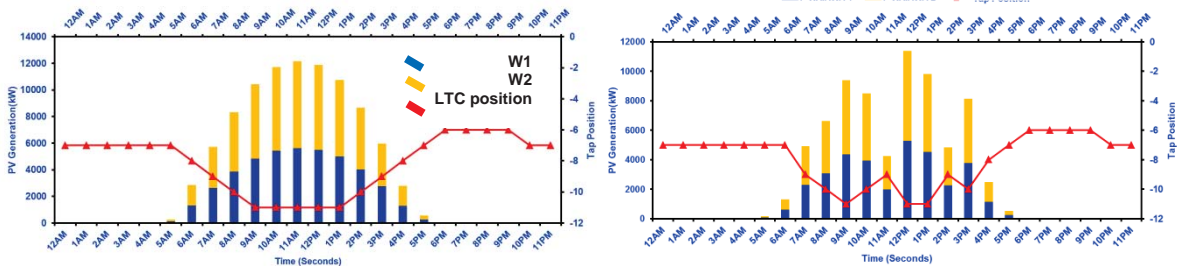

Figure 16: Tap changer position movement with 100% PV on a sunny and cloudy day on WF1

As the PV penetration increases on these variable days, the number of tap changer operations increases from a minimal amount (5) on a clear day with existing penetration, to 2 additional steps (7 total) with 60% penetration, to approximately 4 (9 total) additional operations with 100% penetration. The increase in operations is midday (peak generation time) and during the ramp up and ramp down periods of the PV. At 60% penetration, there are 7 operations on a sunny day due to increased ramp up and ramp down periods; this is increased to 9 with variable cloud cover.

While in other studies a limit for PV penetration is presented, tap changer cycling is a longer-term impact with an increase in operations resulting in mechanical stresses and decreased equipment lifetime. Mitigation strategies for this impact include curtailment at high variability periods, and localized energy storage. A penetration limitation for this feeder for tap changer cycling is based on the level of PV during a high variability period that causes the number of tap

change operations to move above 5.60% PV is therefore the limit. This limit may be reduced with further 20 second time step analysis.

The benefit of including this analysis in standard interconnects is tap changing impacts are better quantified, and HECO can plan for an increased equipment replacement schedule or appropriate these costs to the parties responsible. High fidelity irradiance data is necessary to quantify these impacts. Data must be recorded at the fidelity of the shortest time delay of impacted equipment — in this case the LTC with a delay of 20 seconds.

7 Protection and Short Circuit Analysis

The presence of distributed PV generators in a radial distribution system causes redistribution of the fault current on the feeder circuit. Such redistribution often results in higher current magnitude on the feeder during faults. In case of higher PV penetration, the current may increase considerably, possibly exceeding the ampacity rating of conductors, fuses, breakers, and other equipment. Changes in fault current and direction may also cause a loss of protection coordination between multiple devices. Consequently, the presence of distributed PV generators requires assessments of the impacts on current magnitudes, current direction, and protection coordination during faults.

Both WF1 and WF2 have protection relays in the substation and have fuses on the laterals only, with the exception of a 100A fuse near W1 feeder end. Neither feeder has reclosers nor automated switches, there are only manually operated air-switches.

This study focuses on the changes in current magnitude along the feeder during fault, caused by PV generators. The study explores a range of penetration levels, different locations for the PV generation, different fault locations, and different limits for fault current contribution from PV inverters. Rule 21 uses a 10% fault current increase as a screening point for detailed analysis; HECO considers 5% to be this administrative screen. IEEE-1547 standard for interconnecting DGs with the utility grid does not address the issues of fault current and protection on the distribution grid when DGs are present.

Fault current analyses are completed on the feeder for a variety of PV locations and sizes. To reach the 5% increase in fault current for WF1, a minimum of 72% PV penetration is installed. A 10% increase in fault current at the point of interconnection is not found for this feeder for all penetration levels up to 100% of peak demand. These penetration levels are substantially higher than the current PV penetration level, and many other issues must be considered on WF1 before this penetration level could be reached.

As a result of these simulations, the following factors are identified to contribute to higher fault current increase on WF1:

- Higher PV penetration level
- PV is concentrated rather than distributed
- PV is located closer to the feeder end

- PV inverter has a higher current fault limit
- Fault occurs closer to the feeder end.

The final part of this study evaluates if the protection equipment on WF1 is impacted. The existing protection settings and devices are used to evaluate coordination for an arbitrary 10% fault duty increase level.

The ground and phase relays are set using time delays to operate the ground relay slower than the fuse. As the current, measured by the relay, flows to the distribution network from the sub-transmission, the relay will not have visibility to the fault current duty increases caused by the PV inverters. The interrupt rating of breakers on the 12 kV system is between 14 and 18 kA. The maximum fault duty is increased to a maximum of 4 kA with WF1. The 4 kA fault duty represents the case where PV is concentrated at the end of the feeder, and a fault occurs at the end of the feeder (base case is approximately 3.6 kA). The fault current increases from the base case level to 4 kA at the point of interconnection. The fuse cutout is rated at 12.5 kV. The fuse rating is not exceeded. Protection coordination is also analyzed by plotting the Time Current Curves and evaluating the impact of the increase in fault duty. There is no coordination impact on WF1 with a 10% fault current increase. While the impact of the PV is only considered in this report, continued monitoring of fault duty rise, load characteristics, and quantification of customer side equipment impacts should be considered in conjunction with multiple inverters in one area.

While the scope of this report is limited to a single feeder, current limiting devices on inverters mean there is likely a very large penetration required of PV to reach 10% fault current impact. Even when 10% increase is reached, it is unlikely the 10% increase will impact co-ordination of existing protection equipment, assuming coordination had not been impacted by anything else prior to the study. The main concern with this analysis process is how the interconnect study represents the inverter impact. Further work should be considered to define this area clearly within interconnect standards.

8 Dynamic Studies

Power system stability is the capability of the power system to maintain frequency and voltage. With an increase in distributed resources, there is also an increase in the variability experienced by the normally undisturbed components on a daily basis. A normally undisturbed component is a component not normally subject to dynamic studies, such as an LTC as described previously. Ramping of conventional generators is not traditionally designed for fast ramping to replace variable PV generation. The utility does not control the performance of the PV plant output; therefore the operator must ramp conventional power to meet these variances.

Transient and dynamic analyses are not considered a regular part of an interconnect study for the distribution system. In an islanded system like Oahu, or in a case where the site is part of a cluster, the issue is more prevalent. The necessity of doing this type of analysis and the methodology of completing this is now considered.

The three-phase balanced system model, down to the 12 kV distribution line, is modeled in PSLF. Inverters are modeled at the three-phase aggregate level. The inverter models include

generic response characteristics and under-over frequency protection. Scenarios considered part of the dynamic analysis include:

- N-1 Fault Conditions
- Single Conventional Generator Trip
- Single Transmission (138 kV) Line Trip
- All PV Trip
- Voltage Flicker caused by Irradiance.

These conditions are considered based on the conclusions extracted from measured data on frequency of switching on the feeder (Section 4 showed a large number of switching load changes on WF1). All PV trip can be considered in a steady state analysis, but the dynamic response can contribute more to feeder impacts such as undervoltage, resulting in nuisance protection operation, voltage regulation equipment disturbance and loss of load. A final dynamic condition considered is voltage flicker on the distribution system. Highly variable conditions on a high PV feeder have been perceived as contributing to flicker. The validity of considering a step response versus a time varying irradiance response is considered.

8.1 N-1 Dynamic Analysis

N-1 conditions are generally outside the scope of a distribution interconnection study, but since this study seeks to identify if analyses not normally considered are of interest in High PV scenarios, we consider it here. Standard HECO transmission planning contingencies are considered first, i.e. N-1 Scenarios. Extra measurement models are added for the analysis around the area of interest, particularly the following;

- System Frequency
- Voltage at end of feeder
- Voltage at beginning of feeder 12 kV side
- Voltage at beginning of feeder 46 kV side
- Voltage at beginning of feeder 46 kV line.

In the example below, the largest single conventional generator for HECO is tripped at 5 seconds into the simulation. High PV on WF1 (approximately 60% of peak capacity) and High PV penetration in the W1 Area (8 MW on the distribution side, approximately 25% of noncoincident peak for the sum of all feeders in the W1 Area) is considered. The system frequency is plotted first (Figure 17).

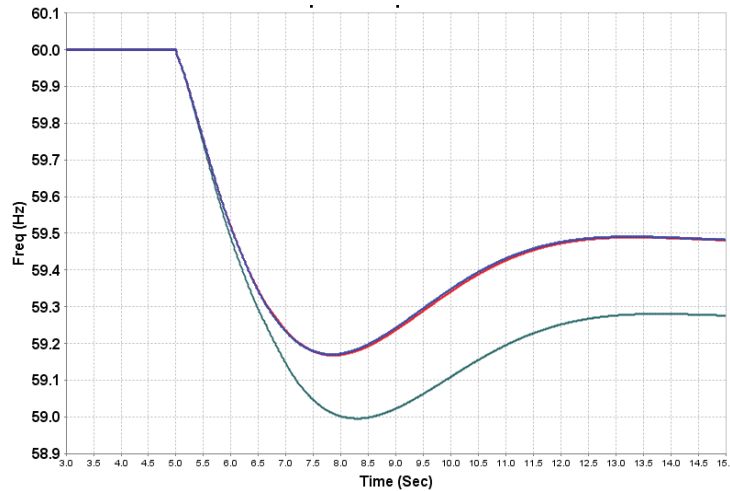

Figure 17: System frequency variation during an N-1 conventional generator trip with no PV (blue), Hi-PV on the WF1 Feeder only (red), and Hi-PV in the W1 area (green)

The conventional generator trip occurred at 5 seconds into the simulation. The blue line in Figure 17 represents the case where no PV is on the system; the red line represents system frequency with high-PV on the WF1 feeder; and the green line represents system frequency with high-PV in the W1 area. At the time of the conventional generator trip, the system frequency drops below the under frequency trip point for the modeled PV inverters and all the PV trips within W1 area. The final system recovery frequency is lower, as expected, when all W1 area generation is lost than in the no PV and High PV WF1-only cases. There is little frequency impact difference between no PV and high PV on WF1 only. Following the frequency analysis, bus voltages are plotted for the distribution level buses (Figure 18). Bus voltages are plotted for the No PV on the system case (blue line) and high PV on WF1 (red line).

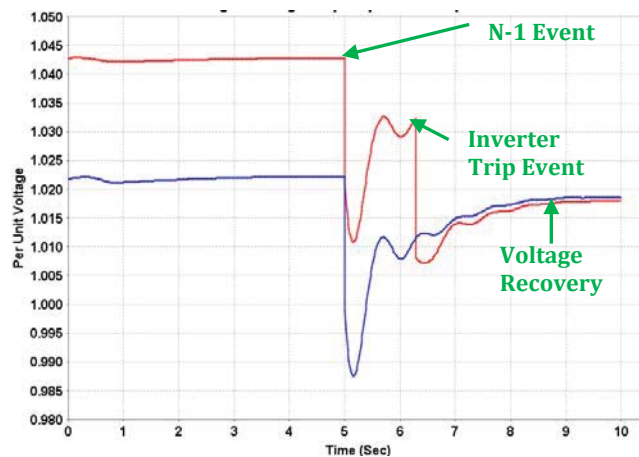

Figure 18: 12 kV bus voltage variation with no PV (blue), and Hi-PV on WF1 (red) during an N-1 conventional generator trip

Comparing the no PV penetration and high PV penetration cases, for bus voltage at the 12 kV and 46 kV level; the blue line represents the no PV case voltage measurement, and the red line represents the High PV case. The voltages at the end and beginning of the 12 kV are initially approximately 0.01 per unit different. When the fault occurs the voltage deviation at the end of the feeder, with no PV, is approximately 4% during the transient, then recovers to 1 per unit in approximately 0.7s. In the high PV case, the initial voltage transient is approximately 3.5% and then the voltage starts to recover after a similar time indicated in the no PV case. Approximately 1 second into the fault there is an under-frequency trip of the PV inverters on WF1, and the voltage again drops by approximately 3%. In total the voltage recover takes approximately 0.7 seconds longer then in the no PV case. While the voltage transient is significant, it is not increased due to the secondary PV generator trip. The longer voltage recovery could impact the operation of protection equipment and should be investigated further.

8.2 All PV Trip Conditions

Next, the impact of the PV tripping on the system itself is considered with no external input causing this trip. An anti-islanding event would cause an all-PV trip in an area to occur. Three levels of penetration are considered initially on WF1 only: existing PV, High PV (approximately 2 MW), and Very High PV (3 MW). The system frequency impact is minimal for these three cases, approximately 0.02 Hz deviation in the 3 MW PV Case. The frequency variance is low at 2 MW, but as the penetration increases the frequency deviation increases, due to the mismatch in load and conventional generation. Voltages at the 12 kV substation bus are plotted for WF1 (Figure 19).

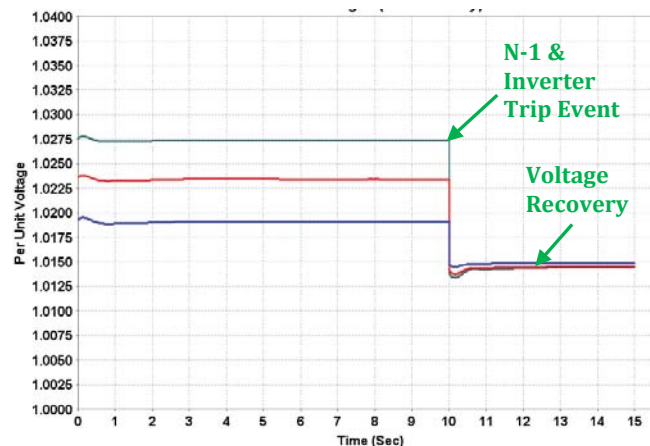

Figure 19: 12 kV bus voltage variation with no PV (blue), Hi-PV on WF1 (red), and very Hi-PV on WF1 (green) during an all PV trip scenario such as an anti-islanding event

In the blue existing PV case in Figure 19, the voltage deviation at the 12 kV buses measured is less than 0.5%. When the PV level is increased to 2 MW, the deviation is approximately 1% (red line). Finally, when the PV level is increased to approximately 90%, the voltage deviation is approximately 1.5%. Using the IEEE limit for instantaneous trip [4] as 3% in the vicinity of load

served customers, the PV penetrations on feeder WF1 do not exceed dynamic limitations during an All PV trip.

As in the N-1 cases, a large penetration of PV is now added in the W1 area (approximately 8 MW total on the distribution side of all area feeders). The impact of all this PV tripping simultaneously is now considered, again as if an anti-islanding event occurred. The system frequency deviation is increased to approximately 0.1 Hz, a non-negligible. The amount of PV is small with respect to the system-wide demand, but the mismatch in load and generation is significant enough to cause a deviation. The bus voltage impact is more significant than system frequency as it concerns the local area. The 12 kV Bus voltage is plotted for these two conditions (Figure 20).

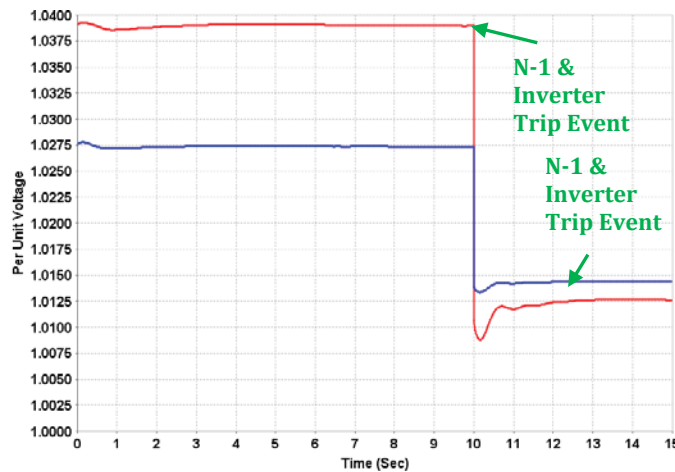

Figure 20: 12 kV bus voltage variation Hi-PV on WF1 (blue) and Hi-PV in W1 area (red) during an All PV trip scenario such as an anti-islanding event

At both ends of the 12 kV feeder the voltage deviation increases to above standard limitations for instantaneous voltage changes, for High PV in the W1 area approximately 3% after the fault has occurred and an extra 0.5% dip during the 0.5s instant after the fault. For High PV penetration on just WF1, limits are not exceeded for instantaneous voltage drop. Finally, the W1 Substation 46 kV Bus voltage change in the All PV trip is plotted at the 46 kV level buses (Figure 21).

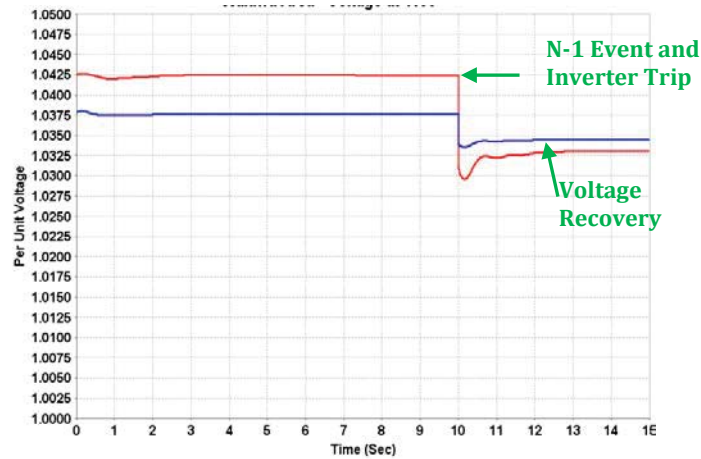

Figure 21: 46 kV bus voltage variation Hi PV on WF1 (blue) and Hi-PV in W1 area (red) during an All PV trip scenario such as an anti-islanding event

At the 12 kV level, the nodal impact of a cluster of PV on the sub-transmission line is significant. At the 46 kV level, the impact of an All PV trip is approximately 2% voltage deviation, which is not an issue if occurring once an hour, but if occurring at a greater frequency then this, it would be considered a problem. A possible occurrence of a recurring trip would be multiple switching operations near to this location, with a time delay of greater than 5 minutes. An inverter will attempt to reconnect to the grid after 5 minutes of an anti-islanding trip. If a second event occurred, the voltage deviation would be outside limits. These results may not show a dynamic issue at the 46 kV level, but do indicate simulation is beneficial before conducting switching operations, another benefit of distribution system modeling. At the higher voltage level, the transient voltage change absorbed by the 46 kV network is larger with a 0.25% dip in voltage for 0.5s on top of the initial voltage change.

The dynamic analysis of N-1 conditions and an All PV trip highlight the importance dynamic nodal and large site analysis have during interconnect assessments. The transient voltage occurrences can result in other cascading impacts on the distribution system and delayed voltage recovery during faults. These conditions could in turn damage equipment and result in nuisance trips and cascading faults. The All PV case in particular for WF1 and W1 area has defined that there is a limitation of approximately 40% for the entire W1 Area. When this is added to the contribution of adjoining areas, the impact could increase at lower penetration levels and limitations on a system wide scale must be addressed.

8.3 Flicker Study

The final part of the WF1 analysis compares two key components of flicker impact from PV installations on this feeder. The first addresses the assumed possible instantaneous 80% reduction (full output capacity to 20% capacity power) in power output from a modeled 5 MW PV site, using general current methodology for evaluating potential flicker from PV power plants. The second identifies the magnitude of flicker experienced by the grid-served customer during a range of irradiance changes, using the collected irradiance data, also for a 5 MW site.

The study methodology for flicker used here is the subject of an IEEE PES 2012 General Meeting Paper by the same authors as this report [6].

Flicker is defined as a rapid objectionable change in light level often produced by voltage fluctuations [8]. Standard interconnect processes for utility-scale photovoltaic generators often include a limited voltage flicker study. High-fidelity irradiance data is often not available and thus not considered part of this analysis. A more simplified power output change from rated capacity to an arbitrary 20% or 0% output is considered. Flicker is typically not measured by utilities but based on a customer (with load served by the utility) raising an issue or complaint. IEEE Standard 519 defines power quality implications of distributed generation and the applicable levels at which flicker is a visible or irritable issue. This analysis seeks to inform and improve the flicker simulation methodology, moving away from the standard assumption of instantaneous trip, to an irradiance-based input methodology that is more representative of PV resources.

The occurrence of voltage flicker is generally more prevalent on weak systems and depends on the strength or stiffness of the system. As proven earlier, this feeder is a strong feeder with a lot of extra capacity, which will dictate the size of source and frequency of fluctuation.

Following the creation of an averaged irradiance sensor grid profile and representative 60 second datasets, two modeling approaches will be taken:

1. Five inverter network with power output controlled by irradiance input
2. Step change in power output from 100% to 0%.

The 5-inverter network is created to represent a 5 MW facility, and the maximum transient voltage deviation at the main collector bus on WF1 is calculated over 60 seconds of each dataset from the representative sensors.

Flicker limitations for PV plant interconnects are defined by HECO using the GE Flicker Curve from IEEE 519-1992. An arbitrary site size is selected, therefore a detailed inverter and panel design and specification is not required.

Voltage measurement models are inserted at three points of interest. The measurement points are identified as Measurement Point 1 0.48 kV collection bus, Measurement Point 2 12 kV point of interconnect, with Measurement Point 3 at the 46 kV substation bus. Only 12 kV results are presented in this summary as it is the main load serving point of interest for power quality issues.

To get an accurate representation of a 5 MW site, we must draw irradiance data from other sources, particularly the Oahu 17 Sensor Airport grid [1]. From the raw data recorded by all 17 sensors, 60 seconds is extracted for each of the maximum ramp instances. For example, to obtain data for the first moment (100% of 800 [W/m²/s]), all data recorded thirty seconds before this moment through 30 seconds after the moment recorded by all 17 sensors is extracted. Five sensors are drawn from the 17 sensor grid to represent a 30-acre site. Two representative days are plotted for the analysis.

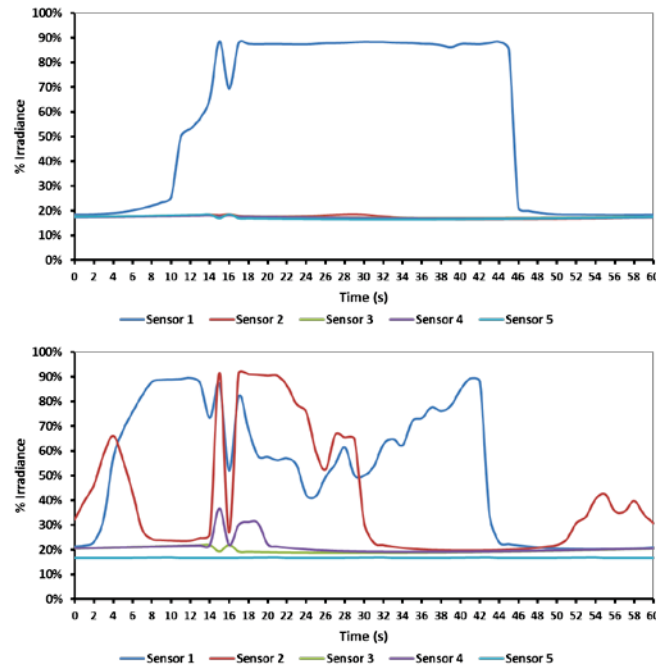

Figure 22: Irradiance plots of two representative variable irradiance days across 5 sensors from the Airport irradiance grid for input to the flicker analysis

Day 1 is classified as a particularly cloudy day and the outputs of most sensors are at low values of around 20%. Day 2 is a maximum variation on any one sensor of 5% less than the maximum variation day. Day 2 represented a more variable cloud day, with each sensor performing differently.

The most common ramp rate in each month occurs approximately 70% of the time and is less than 100 [W/m²/s]. The 50% level reduction from maximum 400 [W/m²/s] occurs at a minimum of 0 times per month, and a maximum of 0.01% per month (equating to 259 incidences). The maximum ramp rate 800 [W/m²/s] occurred a maximum of 0.0005% in May, equating to 13 incidents of 1 second ramp in one month.

Using the generic inverter model and the irradiance files as proxies for power input to each of the 5 generator models, we ran a 60 second dynamic analysis in PSLF and recorded voltages at each of the key buses. The recorded buses are:

- 0.48 kV Low Side PV Plant Bus
- 12 kV Distribution Point of Interconnection
- 46 kV Sub-Transmission Bus.

The voltages at each bus for each day are plotted, and the maximum voltage variation at any one point across the 60s period calculated. The load center is located at the WF1 12 kV. The voltage at this location for all 5 sample irradiance periods is plotted (Figure 23).

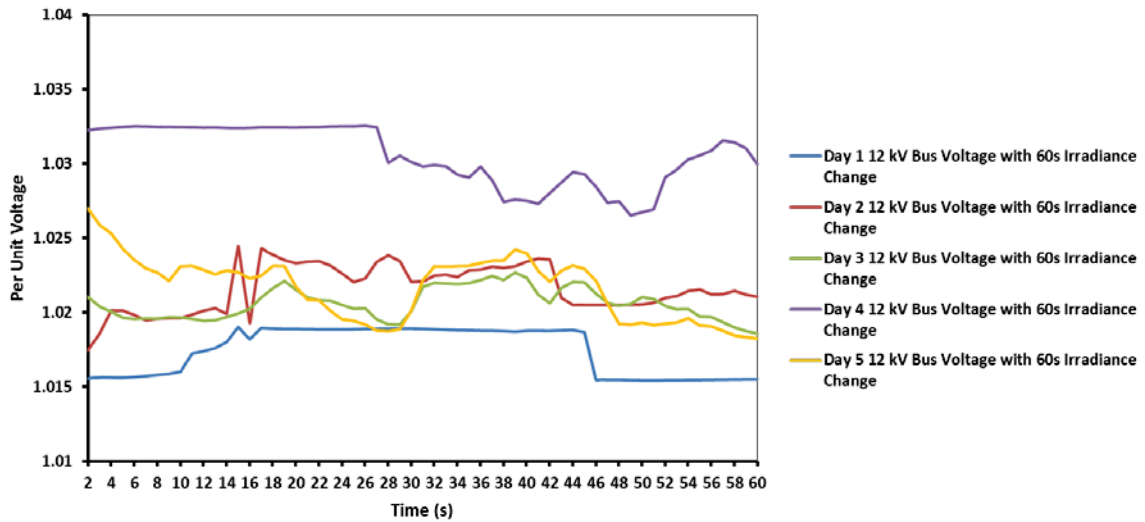

Figure 23: 12 kV bus voltage variation for the 5 highly variable irradiance days input to the dynamic inverter model connected to WF1

In no case did the voltage change in any one second exceed 0.6%. The maximum variation of any irradiance period is plotted (Figure 24) for the main point of interest (12 kV) and the collection bus (0.5 kV).

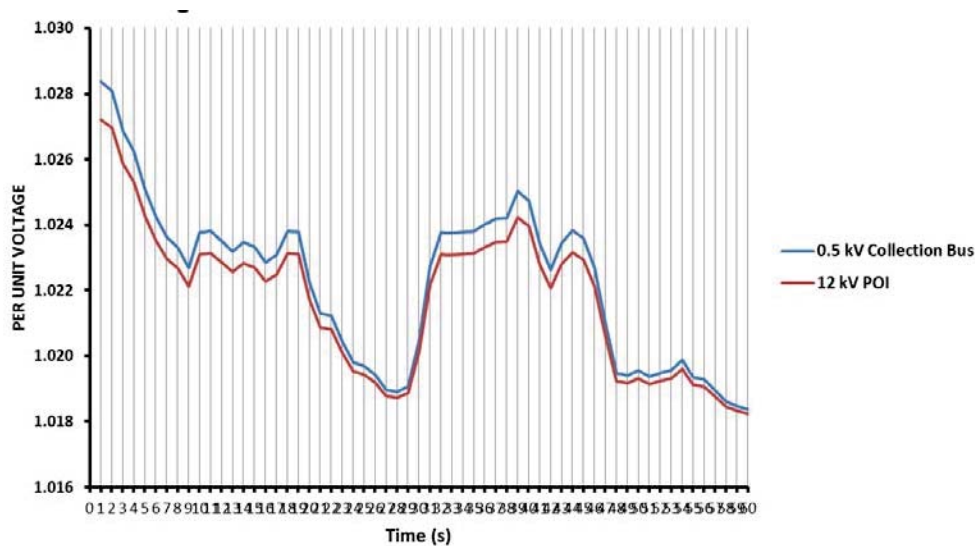

Figure 24: 12 kV bus voltage variation for the most variable voltage response

While the 5th day was the highest impact, the magnitude of the maximum ramp rate in any 1 second was 0.1%. The day of highest impact was not that of densest cloud cover, but that of most variable cloud cover. We refer to the GE Flicker Curve to evaluate the results, as this is standard industry practice (Figure 25).

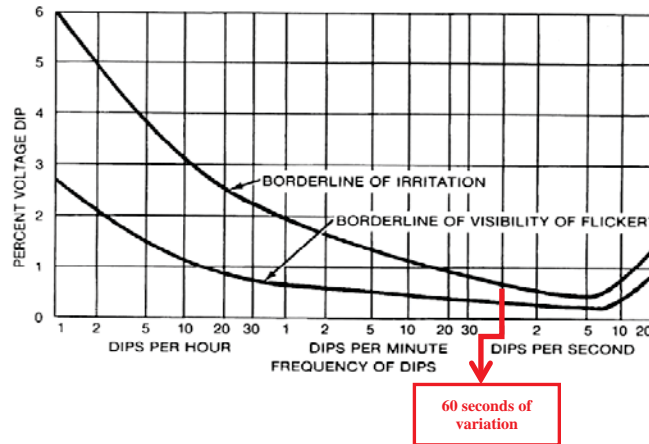

Figure 25: GE flicker curve [4]

The borderline at a frequency of 60 changes per minute for visibility of flicker is 0.3% voltage change, and the borderline for irritability of flicker is approximately 0.6%. Analyses across the full day are also within these limits.

Due to a lack of a robust sample set of solar data and generally accepted practice, PV flicker impact studies frequently consider an instantaneous drop of the PV output from 100% to 0%. This is shown in Figure 26 with the worst days variability and ramp rate from the previous analysis (Day 5). Only the 12 kV voltage is plotted here as it is the main point of interest for where customers load is typically connected.

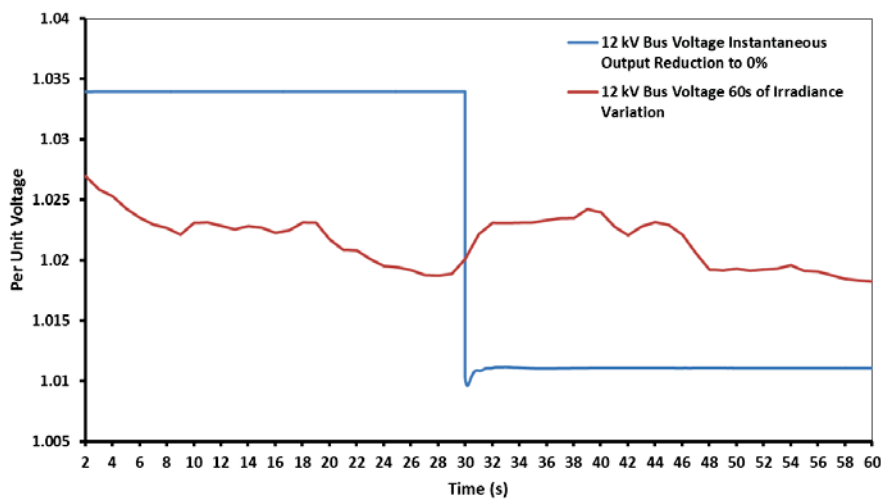

Figure 26: Comparison of 12 kV bus voltage for an instantaneous power output drop and a variable irradiance change

Irradiance Day 5 is compared at the 100% to 0% instantaneous drop. The maximum change is found to increase at the collection bus only; all other buses had similar results. Comparing the instantaneous drop to 0%, there is a more noticeable change, with approximately 2.5% drop in voltage being measured at the 12 kV bus. For the instantaneous drop, no time response

component is added. If we assume this drop occurred once in an hour, the limitation for visibility of flicker defined by IEEE 519[4] is 3%. If the 5 MW utility scale plant trips offline more than once an hour, among being classified as flicker, this is indicative of other issues and would generally occur during emergencies or N-1 conditions. Therefore, it is not considered a normal operational concern.

9 Conclusions and Future Work

9.1 Limitations Specific to WF1

Steady state impacts are limited to variability results and rare incidents where high voltage should be considered. The lightest load on this conductor is as expected, at the end of the feeder, but on average no conductor is loaded above 19%. The average MVA capacity on this feeder is above 6 MVA (based on average amp rating of all cables and voltage). The peak noncoincident demand is approximately 3.2 MVA. The feeder is therefore sized largely above capacity. It is expected the load flow impacts will be limited due to this overcapacity. Future studies should consider a heavier loaded circuit.

Voltage and thermal limits are normally defined by HECO and other utilities as voltage exceeding 1.05 per unit, and thermal loading exceeding 100%. The voltage and thermal steady state limits are highly dependent on location of PV. No limit is defined for PV penetration on WF1 based on the assumption that no potential PV was added greater than the line thermal limit.

A key finding is the line drop compensation setting, and this directly influenced the finding that backfeed is the main PV penetration limitation on WF1. The tap changer and line drop compensation control equipment type installed at W1 transformer does not sense reverse current flow. It therefore has potential at backfeed levels to cause voltage variations on the subtransmission system. As backfeed could realistically occur during a high generation day in April with only 50% to 55% PV penetration of peak, this issue should be considered the first worst issue to be addressed for WF1. PV generation on WF1 cannot exceed 50% of peak without addressing the backfeed issues. While the lifetime of the particular tap changer is not analyzed in this study, a 2 position change represents a 40% increase in operation times. Lifetime of mechanical equipment, including tap changers, is defined based on number of operations. A 40% to 50% decrease in time taken to reach this limitation is therefore considered a major impact for WF1.

Tap changer cycling can cause a decrease in equipment lifetime. Comparison of measured irradiance, power monitor and validated simulation show that irradiance variations can increase the number of tap changer operations. A limitation for PV penetration is defined in this study, that in simulations of varying irradiance conditions, the number of tap changer operations increasing by 2 is a negative impact, and this occurred with 60% PV penetration on WF1. This impact is more long term than short term, and future analyses should run a year of irradiance and power monitor data to fully establish the yearly increase in operations.

Fault current limitation is defined in this analysis based on point where normal administrative filter is reached (5% for HECO, 10% based on Rule 21 at the point of interconnection). Point of

actual impact in this case is not defined. Due to current limiting inverters the 10% filter is not exceeded until above the maximum demand on this feeder.

Dynamic studies included various N-1 conditions and PV system-wide trip. In dynamic, flicker, and harmonic analyses, the benefit of nodal cluster studies is highlighted and the limitations defined based on a combination of substation, feeder, and area penetrations rather than only single feeder. While no real dynamic limitation based on full capacity of PV penetration on WF1 was found, an anti-islanding trip, for example, could have significant impact on WF1 and the W1 area, with instantaneous voltage variations exceeding IEEE limitations at approximately 25% penetration (across all W1 substations, based on noncoincident peak demand). Conventional N-1 conditions such as a generator trip or line trip can cause delayed system voltage recovery. Generator dispatch was fixed in these cases, and modifications are outside the scope of this study.

The final issue considered was flicker, directly linked to the All PV trip case above. A comparison is presented on an instantaneous trip conditions versus a time varying irradiance output. This part of the analysis sought to redefine how flicker impact is quantified for PV, rather than define a limitation on WF1.

9.2 Comparison to Normal Standards and Interconnect Processes

The interconnection process can be a laborious and expensive process for both utilities and developers. If not properly considered using realistic data, this may lead to project time delays and potential gaps in the analysis. Ongoing work focuses on improving the interconnection process by identifying real issues with increasing levels of PV at the distribution level versus simply assuming "rules of thumbs" that may no longer benefit the technical conditions emerging today. A number of conclusions are:

- 15% PV penetration triggering a detailed study is low for a single feeder, but significant for a node, cluster, system area (this has been updated in subsequent releases of rule 14H, December 2011)
- Feeder model validation is essential
- Steady state variability and long term equipment impacts should be quantified with measured data
- Minimum daytime load levels must be considered for voltage trends, backfeed potential, and variability/tap changer cycling impacts
- Currently under Rule 14H only peak loads are considered
- California rule 21: do consider minimum daytime load conditions
- Penetration limits/analysis triggers should be defined at minimum daytime demand levels, 12 kV feeder, node and cluster levels based on 46 kV lines.
- Methodology for flicker studies follows guidelines not designed for high penetrations of PV
- Nodal (substation and feeders) and Cluster Studies (collection of nodes) could reduce initial labor for developers and utilities, and spread the cost over the long term.

While limitations in this analysis are only defined for WF1, a number of benefits were found in simulation and analysis of events such as anti-islanding, prior to conducting operations on the distribution or subtransmission grid. Switching operations should be simulated before conducting operations on feeders to determine the changes in power flow and dynamic response with increasing PV penetrations in nodes and clusters.

9.3 Types and Levels of Analysis Recommended Based on Feeder Study

This analysis has considered a number of detailed studies, and the validity and applicability of each to future interconnect processes is detailed in the Figure below (Figure 27).

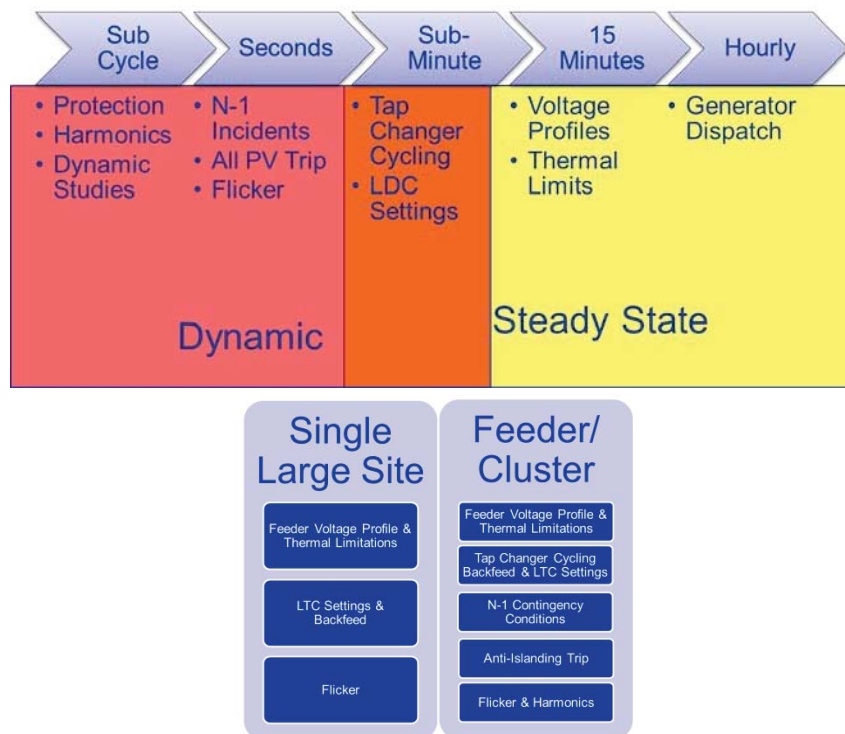

Figure 27: Types of analysis and when to consider during the interconnect process

Cluster studies could be used to better inform the technical interconnect process. HECO would benefit from further studying a quick interconnect plan for PV penetration levels (steady state) at a higher percentage than 15%, but must strongly consider backfeed and cluster impacts. Cluster studies would include dynamic, harmonic, backfeed, and flicker issues. Each site can be considered part of a node or cluster, up to limitation levels. When a cluster study is performed, costs of required upgrades can be apportioned to each developer rather than one person taking the majority of the cost. Inverter modeling dynamically is an essential piece of the analysis and must be integrated at a planning level.

Information such as interconnection transformer type, inverter type, harmonic profiles, and protection settings should be requested from the developer before conducting interconnection and cluster studies. Bi-directionality of equipment (particularly LDC's and regulators) must be

investigated. Transformer LTC and LDC settings should be reviewed with each interconnect, especially in legacy equipment.

9.4 Future Work

Many different types of software were used in this analysis, and the industry must move towards synchronized software formats in the future. Further work should consider a weaker system or more advanced (composite) load modeling to further define impacts. Future work could expand this analysis to considering the following issues:

- Load refinement and composite modeling
- Detailed generation dispatch analysis
- Nodal variability impacts.

10References

- [1] U.S. Department Of Energy HiP-PV Penetration Portal
<https://solarhighpen.energy.gov/projects/cpucs_csi_rdd_high_penetration_solar_projects>
- [2] National Renewable Energy Laboratory Measurement and Instrumentation Data Centre
<<http://www.nrel.gov/midc>>
- [3] IEEE 1547-2003: Standard for Interconnecting Distributed Resources with Electric Power Systems, IEEE, 2003
- [4] IEEE Standard 519-1992: Recommended Practices and Requirements for Harmonic Control in Electrical Power Systems, IEEE, 1993
- [5] IEEE Standard C57.12.00: General Requirements for Liquid Immersed Distribution Power and Regulating Transformers, IEEE 2010
- [6] Electric Power Systems and Equipment—Voltage Ratings (60 Hertz),ANSI Standard Publication no. ANSI C84.1-1995.
- [7] E.M. Stewart, T.P. Aukai, et. al "A Realistic Irradiance-based Voltage Flicker Analysis of PV Applied to Hawaii Distribution Feeders" July 2012, IEEE PES General Meeting Transactions (Accepted)
- [8] G.C. Cornfield, "Definition and Measurement of Voltage Flicker in Lighting" IEE Colloquium on Electronics in Power Systems Measurement. pp. 4/1 - 4/4, Aug 2002

Final Report

TSF-H132 Circuit Penetration Study

Hawaiian Electric Company

August 2014



This page intentionally left blank.

Final Report

TSF-H132 Circuit Penetration Study

Hawaiian Electric Company

August 2014



This report has been prepared for the use of the client for the specific purposes identified in the report. The conclusions, observations and recommendations contained herein attributed to Leidos constitute the opinions of Leidos. To the extent that statements, information and opinions provided by the client or others have been used in the preparation of this report, Leidos has relied upon the same to be accurate, and for which no assurances are intended and no representations or warranties are made. Leidos makes no certification and gives no assurances except as explicitly set forth in this report.

© 2014 Leidos, Inc.
All rights reserved.

TSF-H132 Circuit Penetration Study

Hawaiian Electric Company

Table of Contents

Executive Summary

Section 1 METHODOLOGY	1-1
1.1 Introduction.....	1-1
1.2 Software Application Tools.....	1-2
1.3 Basic Data and Assumptions	1-2
Section 2 STUDY RESULTS	2-1
2.1 Thermal Loading and Voltage	2-1
2.1.1 Impact on Contingency Switching.....	2-8
2.1.2 Impact on Load Tap Changers.....	2-13
2.2 Short Circuit and Protection Analysis	2-15
2.3 Voltage Flicker	2-18
2.4 Load Rejection Transient Overvoltage Evaluation.....	2-20
2.4.1 TOV Results	2-22
Section 3 SUMMARY AND RECOMMENDATIONS	3-1

List of Tables

Table ES-1 Existing NEM Penetration	ES-1
Table 1-1 Existing NEM Penetration.....	1-1
Table 2-1 Existing System Results at Peak Daytime Loading	2-1
Table 2-2 Existing System Results at Minimum Daytime Loading	2-1
Table 2-3 Maximum % PV Growth Identified By Feeder.....	2-2
Table 2-4 Maximum % PV Growth Identified by Substation Transformer	2-2
Table 2-5 Maximum PV Growth Results at Peak Daytime Loading.....	2-3
Table 2-6 Maximum PV Growth Results at Minimum Daytime Loading	2-4
Table 2-7 H132-1 and TSF-H46 Existing Loads and PV Penetration.....	2-9
Table 2-8 Contingency Switching Results at Peak Daytime Loading.....	2-10
Table 2-9 Maximum PV Growth Results at Minimum Daytime Loading	2-11
Table 2-10 Impact on LTC Movement	2-14
Table 2-11 Source Impedance and Existing Fault Calculations	2-15
Table 2-12 Calculated Fault Current at Maximum Penetration Levels	2-15
Table 2-10 TOV Results by Scenario	2-24

List of Figures

Figure ES-1. H132-1 and H132-2 Circuits Overview	ES-2
Figure 2-1. Peak Load Scenario – Maximum PV Growth Scenario – Color by Voltage	2-3

Table of Contents

Figure 2-2. Peak Load Scenario – Maximum PV Growth Scenario – Color by Conductor Loading..... 2-4

Figure 2-3. Min Load Scenario – Maximum PV Growth Scenario – Color by Voltage 2-5

Figure 2-4. Min Load Scenario – Maximum PV Growth Scenario – Color by Conductor 2-6

Figure 2-5. Min Load Scenario – Maximum PV Growth without FIT projects – Color by Conductor 2-7

Figure 2-6. Min Load Scenario – Maximum PV Growth without FIT projects – Color by Voltage 2-8

Figure 2-7. H132/H46-2 Circuit Overview..... 2-9

Figure 2-8. Peak Contingency Scenario – Maximum PV Growth– Color by Voltage..... 2-10

Figure 2-9. Peak Contingency Scenario – Max PV Growth – Color by Conductor Loading.... 2-11

Figure 2-10. Min Load Scenario – Maximum PV Growth Scenario – Color by Voltage 2-12

Figure 2-11. Min Load Scenario – Maximum PV Growth– Color by Conductor 2-13

Figure 2-12. Nuisance Tripping-Fault on H132-1 (3-ph and 1-ph); Impact on H132-2..... 2-17

Figure 2-13. IEEE 519 Voltage Flicker Chart 2-19

Figure 2-14. PSCAD Model Diagram – Three-phase..... 2-20

Figure 2-15. PSCAD Model Diagram – Single-phase details 2-21

Figure 2-16. ITI (CBEMA) Curve 2-23

Figure 2-17. Scenario 1 – Primary Voltage 2-25

Figure 2-18. Scenario 1 – Secondary Voltage 2-25

Figure 2-19. Scenario 2 – Primary Voltage 2-26

Figure 2-20. Scenario 2 – Secondary Voltage 2-26

Figure 2-21. Scenario 3 – Primary Voltage 2-27

Figure 2-22. Scenario 3 – Secondary Voltage 2-27

Figure 2-23. Scenario 4 – Primary Voltage 2-28

Figure 2-24. Scenario 4 – Secondary Voltage 2-28

Figure 2-25. Scenario 5 – Primary Voltage 2-29

Figure 2-26. Scenario 5 – Secondary Voltage 2-29

Figure 2-27. Scenario 6 – Primary Voltage 2-30

Figure 2-28. Scenario 6 – Secondary Voltage 2-30

EXECUTIVE SUMMARY

Introduction

Leidos Engineering, LLC (Leidos) has completed the TSF-H132 Circuit Penetration Study for Hawaiian Electric Company (Company) to determine maximum penetration levels of rooftop distributed solar on two 12.47 kV feeders (H132-1 and H132-2) served from the substation at which TSF-H132 is located. The analysis is intended not only to determine saturation levels for that particular area of the system, but also to extrapolate saturation levels for other similar areas of the Company distribution system.

The following table presents existing levels of Net Energy Metering (NEM), rooftop solar installations, and Feed-In-Tariff (FIT) solar installations on H132-1 and H132-2 circuits.

**Table ES-1
Existing NEM Penetration**

Circuit	Minimum Daytime Load (kW)	NEM (kW)	FIT (kW)	Percent Penetration NEM to Min Load	Percent Penetration NEM & FIT to Min Load
H132-1	1,458	784	1,550	54%	160%
H132-2	962	857	3,150	89%	417%

Figure ES-1 shows the geographic representation of the two H132 circuits.

EXECUTIVE SUMMARY



Figure ES-1. H132-1 and H132-2 Circuits Overview

This report summarizes details of the analysis and findings of the circuit penetration study. The study included a review of short circuit, voltage, capacity, voltage flicker, transient overvoltage, and other impacts. Criteria violations were determined based on Company standards.

Summary of Findings

The analysis, including a voltage and capacity review, short circuit and protection review, high-level voltage flicker analysis, and transient overvoltage analysis, reveals the following.

- The voltage and capacity review indicates:
 - PV growth, beyond the existing level of NEMS on the two H132 circuits, can reach 450% without reaching hard limits defined in the study. This equates to 7.4 MW of interconnected NEMs and 4.7 MW of interconnected FIT projects, which is 500% of the minimum load served from the H132 circuits. The existing level is 6.3 MW, total, for the H132 circuits, which is 262% of the minimum load.
 - Upgrades to primary distribution lines to alleviate capacity and high voltage should be expected as PV installations grow on the distribution system.
 - Higher voltage on the secondary lines with PV growth could require more conductor/cable upgrades on the secondary system than on the primary distribution system. Additionally, as PV penetration grows, more service transformers will require capacity upgrades.
 - Prior to growth of NEM PV by 450% for the two H132 circuits, primary conductors exceed 50% thermal capacity.
 - In contingency conditions, where the Company relies on distribution feeder ties, increased PV penetration could impact available tie capacity. For tie feeders with more load than PV, switching capacity should be available to feeders with heavy PV penetration because the PV will absorb the load, which typically relieves capacity. For tie feeders with more PV than load, switching capacity will be limited to tie to a feeder with a similar heavy PV penetration. On a by-feeder basis, reverse flow should be monitored and considered when tying circuits together in a contingency. If there are not multiple feeder tie options for some areas of the Company system and increased levels of PV create difficulties in contingency switching, the Company could consider requiring PV to be offline under contingency situations. If requiring the PV offline under contingency situations is not plausible, the Company should limit reverse flow to 50% in order to maintain normal traditional planning and operational flexibility.
 - Excessive substation transformer load tap changer (LTC) movement is not expected to be an issue for the TSF-H132 transformer. The current LTC settings are acceptable for this substation as well. For other areas of the Company distribution system, if feeders have a larger bandwidth of voltage measurements, the Company may consider adding line voltage regulators to reduce feeder voltage bandwidth or consider alternative LTC settings, where it continues to regulate in the forward position, even in reverse flow conditions, which is referred to as co-generation mode. Leidos recommends co-generation model for voltage regulators on the distribution feeders.
- The short circuit and protection review revealed the 450% growth of NEMS should not be a concern related to feeder relay interrupting ratings. In addition, sympathetic or nuisance trips

EXECUTIVE SUMMARY

on relays are not expected to be an issue for feeders that do not have a low-set instantaneous or mid-line protective devices. Tap fuses will need to be replaced/upgraded as loading on taps increases with additional PV growth.

- The high-level voltage flicker evaluation indicates that voltage flicker concerns could increase as PV penetration increases. The Company should consider adding monitoring devices on the distribution system where there are high levels of PV penetration to capture short-term and long-term flicker, Pst and Plt, respectively. Pst should be limited to 0.9 and Plt should be limited to 0.7 for the medium distribution system based on the IEC 61000-3-7 standard. As the monitoring devices show Pst and Plt values getting closer to these limits, the Company can either make system upgrades such as conductor or cable upgrades to lessen the impact of voltage flicker, require inverters to operate off unity to reduce the voltage differential when they drop out, install battery storage systems, or restrict additional PV in those areas.
- The Transient Overvoltage (TOV) analysis indicates that without mitigation, levels of NEM PV and FIT PV penetration on distribution feeders can reach 200% penetration. Beyond that, mitigation strategies could include requiring inverters to have fast trip functionality or installing automatic transfer switches at NEM PV locations to trip them off-line faster than the inverter internal programmed response. Leidos recommends measuring voltages from actual load rejection events to compare to the results of the study, which will further justify any Company policy changes or system operating procedures.

Overall, the H132 circuits have very strong backbone conductor/cable sizes, which allow more PV penetration in the area. In other areas of the Company system where there are smaller wire sizes, PV growth may be limited more due to voltage, capacity, and voltage flicker.

Additional Considerations

This study does not consider issues on the transmission system or existing generators (including utility scale solar and wind projects) such as stability, ramp capability, or unit startup time. To meet stability requirements, Synchronous Condensers (SC) may be required to provide voltage and inertia support not received from the renewables. Battery storage at substations or utility scale renewable installations can address ramp capability and unit startup time. Fast start units can also bring inertia and voltage support, as well as fast ramp and startup capabilities.

A combination of SC, battery storage and fast start units may be the most reliable and economic option. Other possibilities are DC submarine cable ties between the islands, geothermal storage, or curtailment of renewable generation, even rooftop PV, by remote control or installation limits. The Company will still need to have enough spinning reserve in order to meet its requirement for the loss of the Most Severe Single Contingency (MSSC). Conversion from oil to natural gas when replacing older units for increased efficiency may reduce costs.

In addition to the technical impacts, significant PV penetration could increase the cost of service to the Company and non-PV customers due to mitigation costs, reduced revenue from Net Energy Meters to fund required infrastructure and the reduced heat rate and increased O&M of existing generators running below minimum load levels. Leidos recommends a holistic approach that considers rates and the economic impacts in addition to the technical impacts of increased PV on the transmission system and existing generators, as well as the distribution system and

substations. The Company should perform studies and implement demonstration projects of viable options.

This page intentionally left blank.

Section 1 METHODOLOGY

1.1 Introduction

The Circuit Penetration Study was performed on two H132 circuits served from the substation at which TSF-H132 is located. The substation has two 46-12.47 kV, 10/12.5 MVA transformers and one 46-13.09 kV, 10/12 MVA transformer. TSF-H131 serves H131-1, TSF-H132 serves Circuits H132-1 and H132-2, and TSF-H133 serves H133-1. There is approximately 1.64 MW of NEM, rooftop solar installations, and 4.7 MW of FIT, utility scale installations, on H132-1 and H132-2. Existing penetration levels are shown below in Table 1-1.

**Table 1-1
Existing NEM Penetration**

Circuit	Maximum Daytime Load (kW)	Power Factor at Max Load	Minimum Daytime Load (kW)	Power Factor at Min Load	NEM (kW)	FIT Projects (kW)	Percent Penetration NEM to Min Load	Percent Penetration NEM & FIT to Min Load
H132-1	3,586	97%	1,457	97.0%	784	1,550	54%	160%
H132-2	2,161	99%	962	99.0%	857	3,150	89%	417%

Note: The power factor was calculated based on average feeder power factor measured in January.

The NEM installations were modeled in SynerGEE as spot loads. The Company did provide information on 11 FIT projects where specific service transformers and PV generation facilities were modeled explicitly.

For determining when saturation limits would arise from increasing PV penetration, the Company and Leidos worked together to determine system limitations.

Hard limits, defined as issues that arise that would not be addressed through a system improvement to accommodate additional NEMs, include:

- Substation transformer loading – 10 MVA for TSF-H132
- Underground exits for each circuit – these are already 1000 AL or 750 CU, which are the largest sizes the Company utilizes

Operational limits, defined as issues that arise that could be addressed through a system improvement to accommodate additional NEMs, include:

- Conductor/cable loading on the feeder where the maximum size utilized by the Company is not in use
- Minor high or low voltage
- Replacement of equipment such as regulators or protective devices due to capacity or reverse flow limitations

Section 1

Leidos increased existing penetration levels, using SynerGEE, to evaluate voltage and capacity on the two H132 circuits. Initially each feeder was analyzed individually at maximum and minimum daytime load scenarios to determine maximum penetration levels based on hard limits for the feeder. When feeder hard limits were identified, PV penetration was increased, simultaneously, on both feeders served from the substation transformer to determine if a substation transformer hard limit would be reached sooner than on an individual feeder basis. This process was completed in two scenarios; one with the FIT projects online and the other with them turned off.

Upon identifying the maximum penetration levels, short circuit analysis was completed to determine the impact on protection at those levels. Also, a high-level voltage flicker assessment was completed. Impacts from the maximum penetration level of PV on transient overvoltage (TOV) was also investigated.

1.2 Software Application Tools

The study was completed using SynerGEE, ASPEN, and PSCAD software. SynerGEE was used for the voltage and capacity evaluation; ASPEN was used for short circuit and protection analysis; and PSCAD was used for the TOV investigation. The voltage flicker assessment was performed using results from the other models.

1.3 Basic Data and Assumptions

For the circuit penetration study, the following data and assumptions were included:

- The Company provided the gross daytime minimum and maximum loads for each feeder, which is the value recorded, not including distributed generation that may have been online at the time. The Company provided one month of 15-minute metered feeder data, including kW and kVAR, which was used to calculate average power factor for each feeder.
- Unity power factor was studied for the PV output for each NEM and FIT project.
- The Company provided source impedance for the substation at the 46 kV and 12.47 kV bus in the ASPEN Oneliner model.
- Each 46 kV – 12.47 kV transformer was modeled in SynerGEE with the substation transformer LTCs.
- There are no capacitors on the H132 circuits.
- There is one bank of 250 kVA single-phase voltage regulators on H132-2.
- The following standards were used in the analysis:
 - IEEE Standard 1547-2008, “IEEE Standard for Interconnecting Distributed Resources with Electric Power Systems”
 - Company Engineering Standard Practices (ESPM)
- The following operational planning criteria were considered for the analysis:
 - Primary distribution line voltage should remain between 114 V – 126 V in order to maintain the ANSI standard service voltages; noted on a 120-volt base.

- Substation transformer loading limited to 100% of base nameplate.
- Conductor/cable loading limited to 100% of thermal capacity.
- In this report, penetration of PV to load is referenced as percent daytime minimum load (% DML) and percent daytime peak load (% DPL)

This page intentionally left blank.

Section 2 STUDY RESULTS

2.1 Thermal Loading and Voltage

Using SynerGEE to analyze capacity and voltage, the following results for the existing NEM and FIT penetration levels include maximum percent conductor/cable loading, maximum and minimum primary distribution voltage, circuit level and substation transformer level kW and kVAR values, and substation transformer tap positions.

**Table 2-1
Existing System Results at Peak Daytime Loading**

Location	Peak Load (kW) ¹	kVAR	Maximum Percent Conductor/Cable Capacity ²	Maximum Voltage on a 120-volt base (V)	Minimum Voltage on a 120-volt base (V)	Substation Transformer Tap Position
H132-1	843	986	32%	118.6	115.0	N
H132-2	-2002	413	55%	122.8	118.0	N

Notes:

1. Includes existing NEM and FIT PV locations.
2. Represents results for primary 12.47 kV elements in the SynerGEE model on each feeder.

**Table 2-2
Existing System Results at Minimum Daytime Loading**

Location	Min Load (kW) ¹	kVAR	Maximum Percent Conductor/Cable Capacity ²	Maximum Voltage on a 120-volt base (V)	Minimum Voltage on a 120-volt base (V)	Substation Transformer Tap Position
H132-1	-1177	354	11%	120.4	119.6	N
H132-2	-3074	249	68%	125.7	119.6	N

Notes:

1. Includes existing NEM and FIT PV locations.
2. Represents results for primary 12.47 kV elements in the SynerGEE model on each feeder.

The existing level of NEM PV was incrementally increased, considering the existing FIT projects online, until hard limits were reached. The maximum penetration levels are presented below, as well as identification of the actual hard limit reached.

In incrementally increasing NEM PV penetration on each feeder individually, Leidos found the following allowable PV growth percentages for each feeder.

Section 2

**Table 2-3
Maximum % PV Growth Identified By Feeder**

Location	Maximum % PV Growth at Peak Load	Total PV (NEM & FIT) (kW)	% DPL	Hard Limit Reached	Maximum % PV Growth at Min Load	Total PV (NEM & FIT) (kW)	%DML	Hard Limit Reached
H132-1	>1000%	9,390	262%	Substation transformer loaded to 100%	900%	8,606	591%	Substation transformer loaded at 100%
H132-2	>1000%	11,720	542%	Substation transformer loaded to 100%	800%	10,006	1,040%	Substation transformer loaded at 100%

Note: If hard limits were not reached beyond 1000% PV growth, analysis stopped at 1000%.

Once the maximum percent PV growth by feeder was identified, Leidos ran simulations on each substation transformer, growing NEM PV penetration two feeders at a time using the same growth percentage for both feeders. The existing FIT projects were online for simulations.

**Table 2-4
Maximum % PV Growth Identified by Substation Transformer**

Location	Maximum % PV Growth at Peak Load	Total PV (NEM & FIT) (kW)	%DPL	Hard Limit Reached	Maximum % PV Growth at Min Load	Total PV (NEM & FIT) (kW)	%DML	Hard Limit Reached
H132-1 & H132-2	650%	15,367	267%	Substation transformer loaded to 10 MVA	450%	12,085	500%	Substation transformer loaded to 10 MVA

At peak load, the hard limit for maximum percent PV growth is the substation transformer size of 10 MVA. Transformer backfeed loading reaches this limit at 650% NEM PV growth on TSF-H132, equating to 247% DML. Leidos modeled this load growth in SynerGEE, and the results are summarized in Table 2-5 and Figures 2-1 and 2-2. The results present the maximum percent conductor/cable loading, maximum and minimum primary distribution voltage, circuit level and substation transformer level kW and kVAR values, and substation transformer tap positions for the maximum penetration levels identified. Exceptions to operational capacity limits can be seen in the figures.

Table 2-5
 Maximum PV Growth Results at Peak Daytime Loading

Location	Peak Load (kW) ¹	kVAR	Maximum Percent Conductor/Cable Capacity ²	Maximum Voltage on a 120-volt base (V)	Minimum Voltage on a 120-volt base (V)	Substation Transformer Tap Position
H132-1	-3,003	1,078	38%	123.0	117.0	N
H132-2	-6,360	792	86%	128.0	118.0	N

Notes:

1. Includes existing NEM PV locations grown at 650% on H132-1 & H132-2 circuits, (267% DML).
2. Represents results for primary 12.47 kV elements in the SynerGEE model on each feeder.

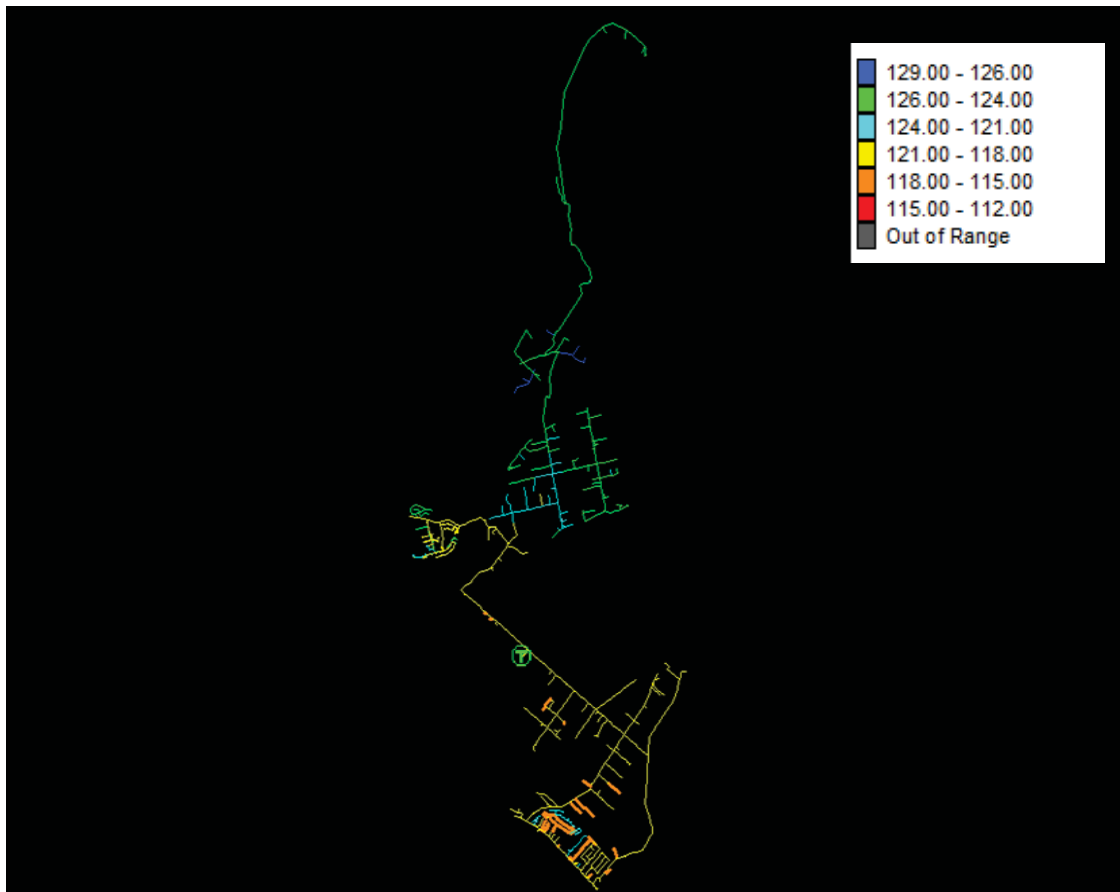

Figure 2-1. Peak Load Scenario – Maximum PV Growth Scenario – Color by Voltage

Section 2



Figure 2-2. Peak Load Scenario – Maximum PV Growth Scenario – Color by Conductor Loading

At minimum load, the hard limits for maximum percent PV growth is also the substation transformer size of 10 MVA; however, at minimum load, the transformer backfeed load reaches this limit at 450% NEM PV growth, equating to 500% DML. Leidos modeled this load growth in SynerGEE and summarized the results in Table 2-6 and Figures 2-3 and 2-4. Exceptions to operational capacity limits can be seen in the figures.

Table 2-6
Maximum PV Growth Results at Minimum Daytime Loading

Location	Peak Load (kW) ¹	kVAR	Maximum Percent Conductor/Cable Capacity ²	Maximum Voltage on a 120-volt base (V)	Minimum Voltage on a 120-volt base (V)	Substation Transformer Tap Position
H132-1	-3,656	459	36%	121.7	119.2	N
H132-2	-5,879	496	88%	128.1	119.1	N

Notes:

1. Includes existing NEM PV locations grown at 450% on H132-1 & H132-2 circuits (500% DML).
2. Represents results for primary 12.47 kV elements in the SynerGEE model on each feeder.

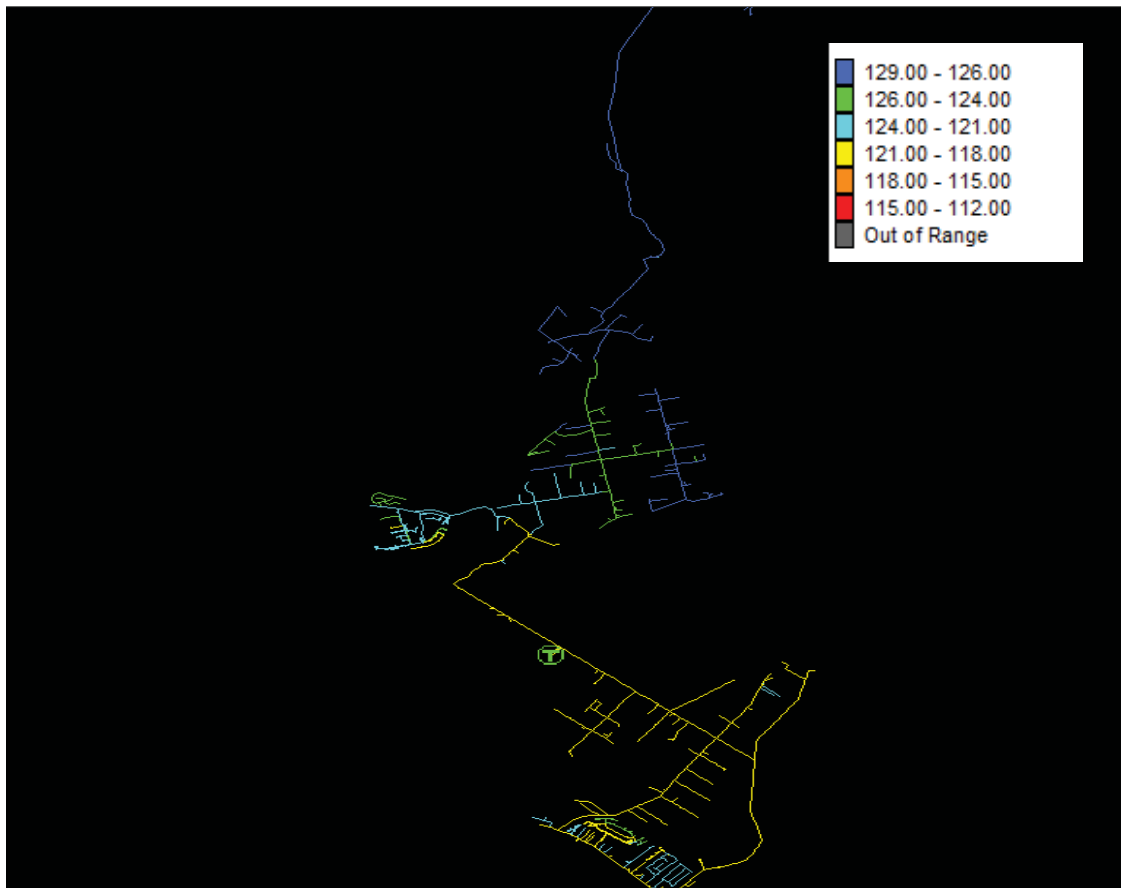

Figure 2-3. Min Load Scenario – Maximum PV Growth Scenario – Color by Voltage

Section 2



Figure 2-4. Min Load Scenario – Maximum PV Growth Scenario – Color by Conductor

In comparing the by-feeder results to the by-substation transformer results, the minimum load analysis by substation transformer is the limiting PV growth case. The H132 circuits can grow in PV penetration by 450% before reaching the hard limit of substation transformer capacity.

While the results identified minor high voltage on the primary distribution system, the Company is expected to have more high-voltage areas on the secondary system and an increased number of service transformers over capacity, as identified in the TSF-158 & TSF-159 Circuit Penetration Study. The minor high voltages seen on the primary distribution system can be mitigated by upgrading the conductor size.

The simulations conducted above were also completed with the FIT projects turned off to determine how much additional NEM penetration could be allowed before reaching hard limits, not including the existing FIT projects. The simulations show that NEM PV growth can reach 780% on each feeder, at minimum load conditions, before reaching the hard limit of substation transformer capacity, which equates to 532%.

Figures 2-5 and 2-6 illustrate the voltage and capacity conditions of the feeders with NEM PV growth at 780% at minimum load conditions without the existing FIT projects online. Exceptions to operational capacity limits can be seen in the figures.

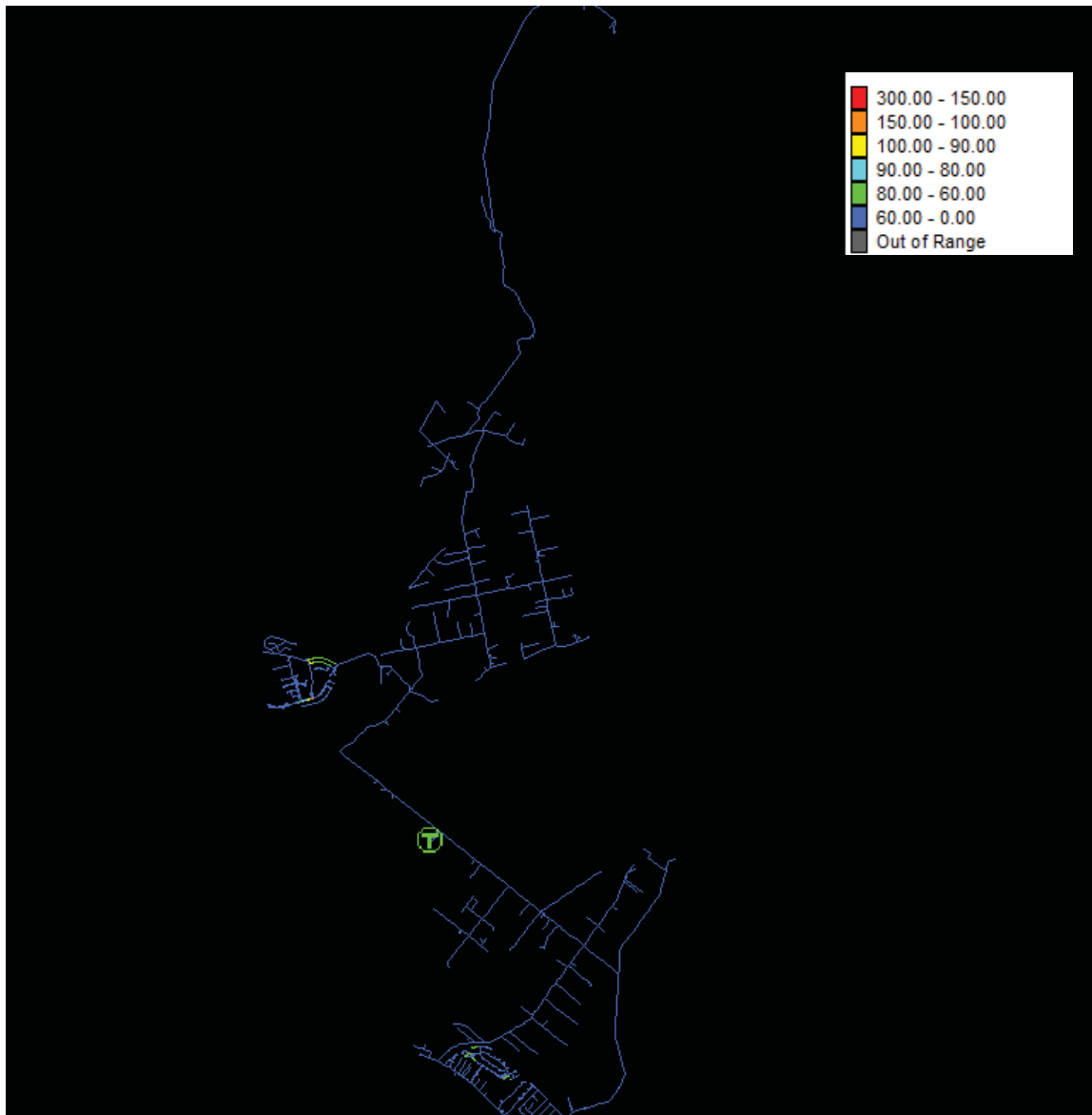

Figure 2-5. Min Load Scenario – Maximum PV Growth without FIT projects – Color by Conductor

Section 2



Figure 2-6. Min Load Scenario – Maximum PV Growth without FIT projects – Color by Voltage

2.1.1 Impact on Contingency Switching

In contingency conditions, where the Company relies on distribution feeder ties, increased PV penetration could impact available tie capacity. Leidos performed a simulation to determine the impact. The scenario includes switching the entire H46-2 circuit to H132-1, with H132-1 at the maximum PV penetration level identified. The peak and minimum daytime loads were evaluated with NEM PV growth at 450% of the current level for H132-1. Table 2-7 presents the minimum and peak daytime loads for H132-1 and H46-2 as well as the total existing NEM and FIT projects interconnected for each circuit.

Table 2-7
 H132-1 and TSF-H46 Existing Loads and PV Penetration

Circuit	Maximum Daytime Load (kW)	Power Factor at Max Load	Minimum Daytime Load (kW)	Power Factor at Min Load	NEM (kW)	FIT Projects (kW)	Percent Penetration NEM to Min Load	Percent Penetration NEM & FIT to Min Load
H132-1	3,586	97%	1,457	97%	784	1,550	54%	160%
H46-2	3,519	90%	2,241	90%	1,329	0	38%	38%

Note: The power factor was calculated based on average feeder power factor measured in January for TSF-H132, and an assumed power factor provided by the Company for TSF-H46.

The existing circuit configurations of H132-1, H132-2, and H46-2 are shown in Figure 2-7.

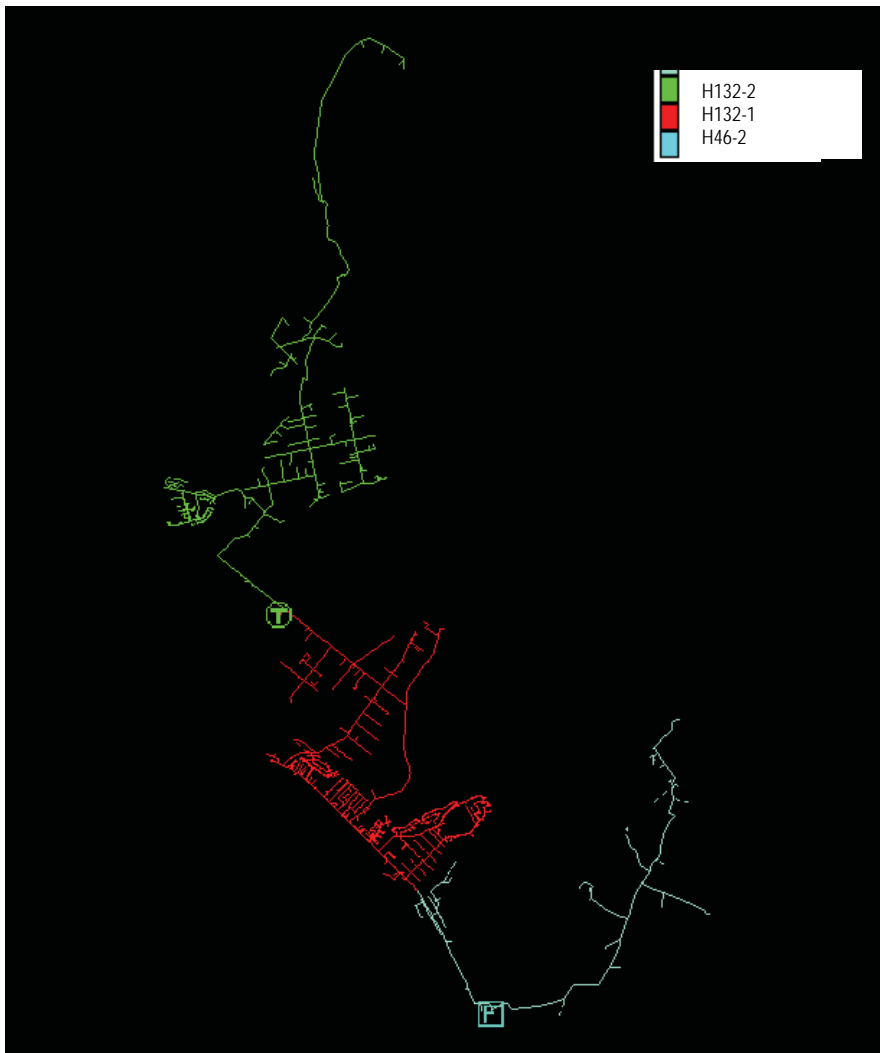

Figure 2-7. H132/H46-2 Circuit Overview

Section 2

Results from the peak load scenario are shown below. Voltage nearing the low voltage end of the acceptable range was identified on the portion of the feeder normally served by TSF-H46. There were no capacity violations.

Table 2-8
Contingency Switching Results at Peak Daytime Loading

Location	Peak Load (kW)	kVAR	Maximum Percent Conductor/Cable Capacity	Maximum Voltage on a 120-volt base (V)	Minimum Voltage on a 120-volt base (V)	Substation Transformer Tap Position
H132-1 with H46-2	-1,484	861	41%	121.8	115.3	N

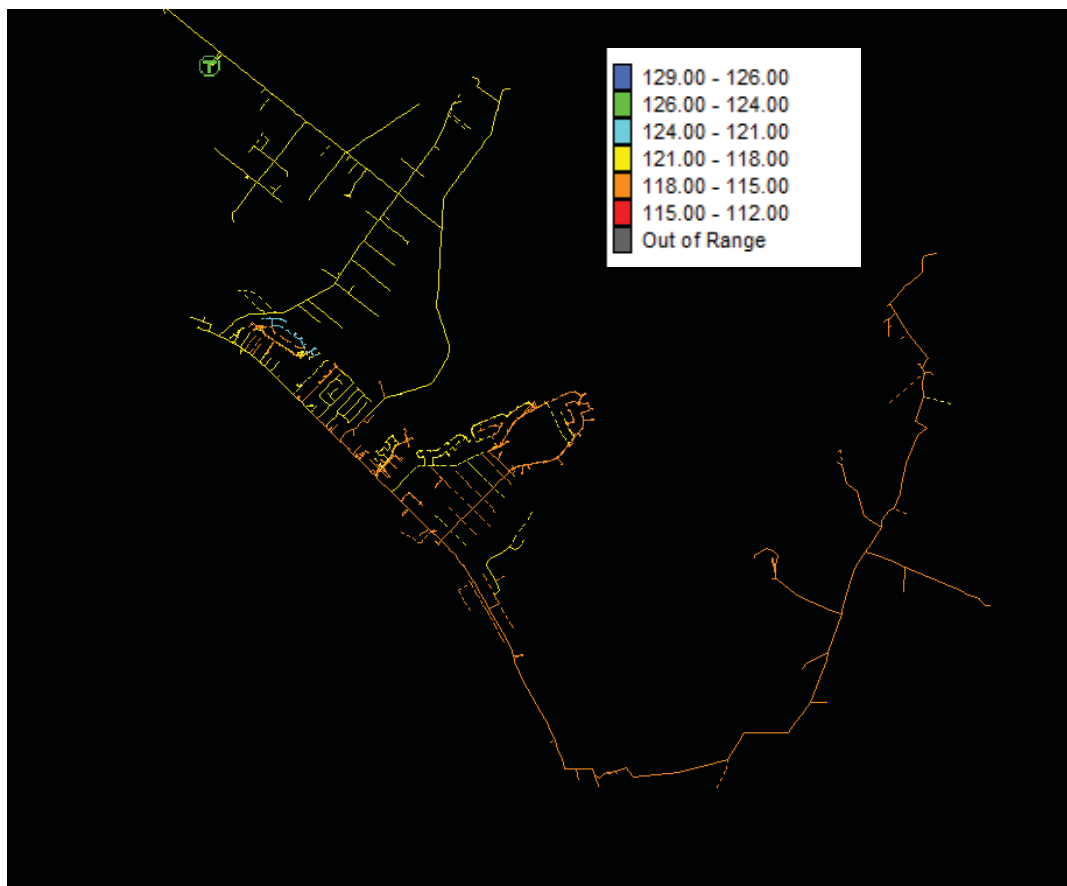

Figure 2-8. Peak Contingency Scenario – Maximum PV Growth– Color by Voltage

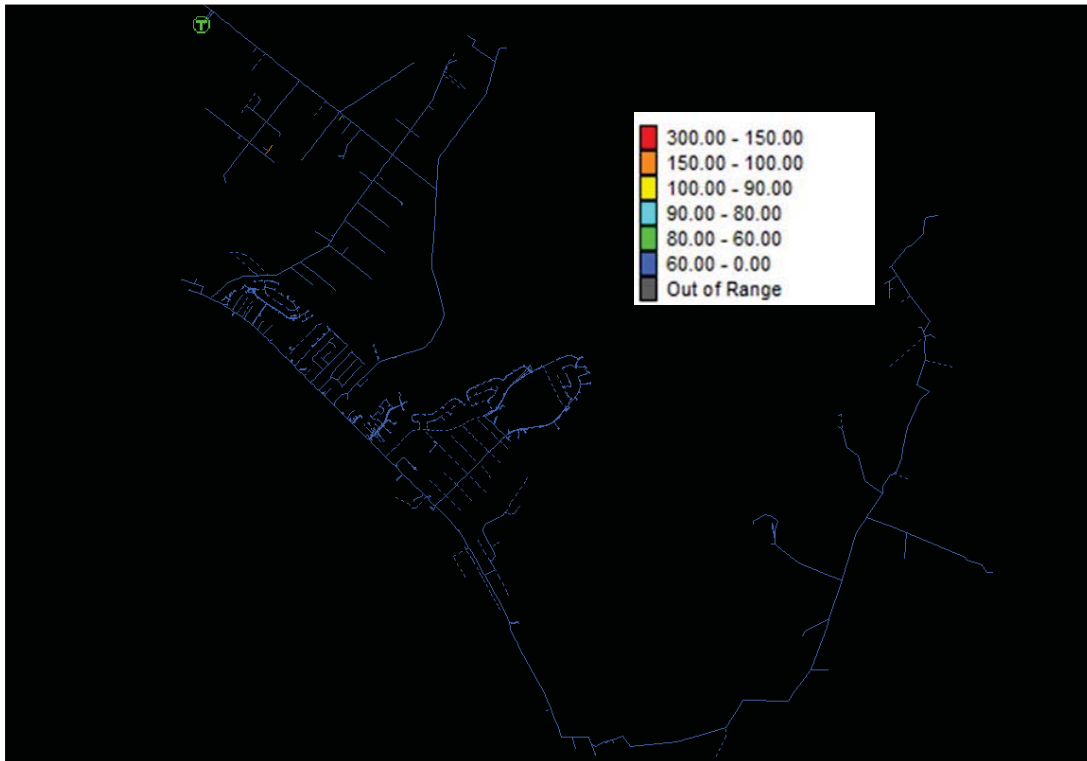

Figure 2-9. Peak Contingency Scenario – Max PV Growth – Color by Conductor Loading

Results from the minimum load scenario are shown below. The analysis indicates that the substation transformer in the contingency scenario can accommodate more PV growth on the H132 circuits, greater than 450%. The H46-2 circuit has more load than PV. Therefore, transferring H46-2 to H132-1 in a contingency allows for the excess PV on H132-1 to absorb more load and results in less reverse load through the substation transformer TSF-H132, which is a hard limit defined for this study.

Low voltage on the portion of the feeder normally served by TSF-H46 was identified. There were no capacity violations.

Table 2-9
Maximum PV Growth Results at Minimum Daytime Loading

Location	Peak Load (kW)	kVAR	Maximum Percent Conductor/Cable Capacity	Maximum Voltage on a 120-volt base (V)	Minimum Voltage on a 120-volt base (V)	Substation Transformer Tap Position
H132-1 with H46-2	-2,360	1,473	44%	120.1	113.9	N

Section 2

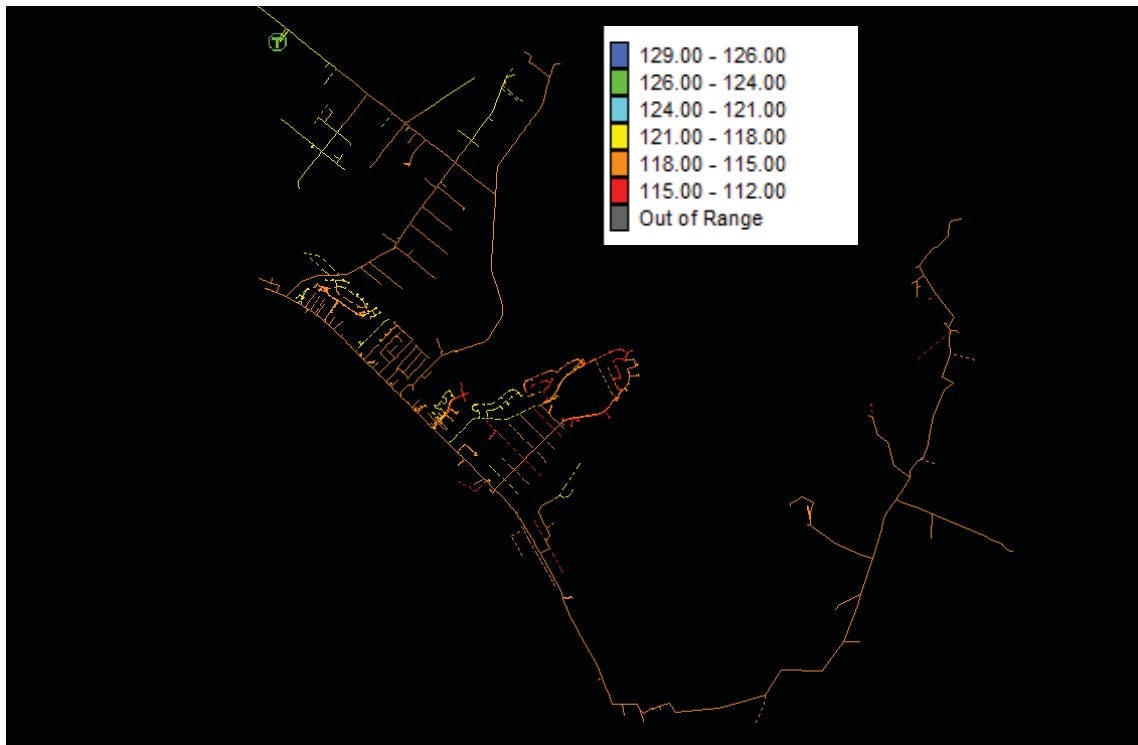

Figure 2-10. Min Load Scenario – Maximum PV Growth Scenario – Color by Voltage

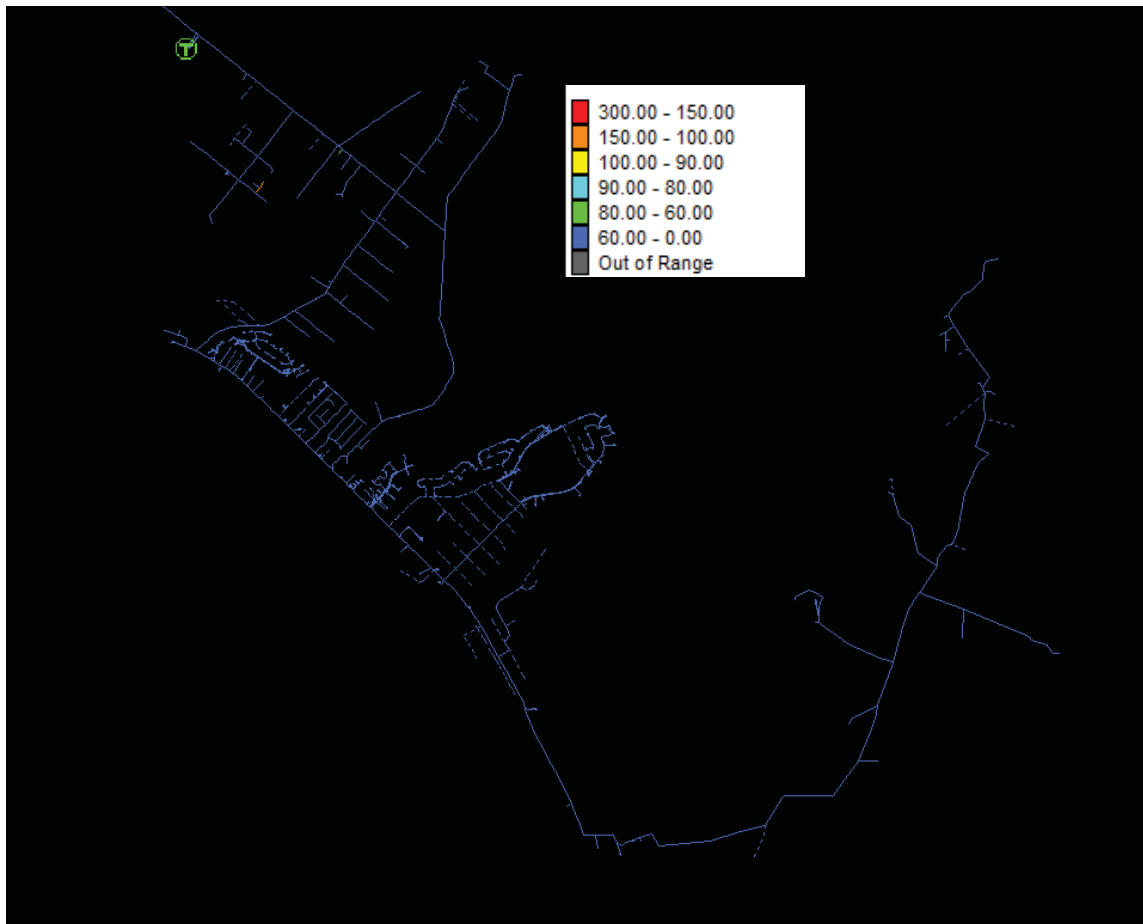

Figure 2-11. Min Load Scenario – Maximum PV Growth– Color by Conductor

The contingency analysis shows that for tie feeders with more load than PV, switching capacity should be available to feeders with heavy PV penetration because the PV will absorb the load, which typically relieves capacity. It can be derived that for tie feeders with more PV than load, switching capacity will be limited to tie to a feeder with a similar heavy PV penetration. On a by-feeder basis, reverse flow should be monitored and considered when tying circuits together in a contingency. If there are not multiple feeder tie options for some areas of the Company system and increased levels of PV create difficulties in contingency switching, the Company could consider requiring PV to be offline under contingency situations. If requiring the PV offline under contingency situations is not plausible, the Company should limit reverse flow to 50% in order to maintain normal traditional planning and operational flexibility.

2.1.2 Impact on Load Tap Changers

TSF-H132, which serves feeders H132-1 and H132-2, is equipped with a load tap changer (LTC). In the current state, it is designed to lock out in reverse flow conditions and not continue to move tap positions as load in the reverse direction moves through the transformer. The set point voltage is 120 V, and the bandwidth is +/-1 V (or 2 V total). The time delay for adjustments is

Section 2

30 seconds. The analysis was simulated with these setting, and the results show that when reverse flow moves through the substation transformer, the LTC locks at neutral.

To gather perspective on the impact of tap movement, Leidos modeled various levels of PV penetration to investigate tap movement on the TSF-H132 transformer LTC. Other than evaluating the peak and minimum system load conditions, Leidos did not evaluate fluctuations in consumer load that would also affect tap position.

**Table 2-10
Impact on LTC Movement**

Scenario	Total NEM PV (kW)	Total FIT PV (kW)	TSF-H132 Distribution Bus Voltage (V)	TSF-H132 LTC Tap
Peak Load - Existing	1,640	4,700	118.6	N
Peak Load -Existing – No PV	0	0	119.8	2R
Peak Load - 200% PV Growth	3,280	4,700	118.7	N
Peak Load - 300% PV Growth	4,920	4,700	118.7	N
Peak Load - 400% PV Growth	6,560	4,700	118.6	N
Min Load - Existing	1,640	4,700	119.5	N
Min Load - Existing – No PV	0	0	119.6	N
Min Load - 200% PV Growth	3,280	4,700	119.4	N
Min Load - 300% PV Growth	4,920	4,700	119.3	N
Min Load - 400% PV Growth	6,560	4,700	119.2	N

In the peak load scenario, the LTC is at tap 2R for the existing system with no PV on the system. The analysis shows that the tap is at neutral position for each level of PV penetration analyzed, including the existing level of penetration. Because the existing level of penetration on these feeders, including FIT projects, is high, there is already reverse flow on through the substation transformer and the tap is at neutral. Leidos does not anticipate much, if any, movement from the substation tap for TSF-H132 with an increase in PV penetration.

Leidos recommends recording and monitoring LTC and line regulator tap movement to get a more accurate depiction of the impacts of PV on the system at the current level of interconnection and as it increases. If the Company has a planning criteria for limiting tap changes annually, for example, recording tap movement can be used to determine when the planning criteria is violated and be an indicator of PV saturation on the substation transformer and/or feeder.

From the analysis, it appears that the current LTC control setting is acceptable for the substation transformer analyzed. There is an existing bank of single-phase voltage regulators on the H132-2 feeder that appear to be offline, and low voltage was not calculated on H132-2 without the regulators. If the regulators do go back into service, Leidos recommends co-generation mode, which allows the regulators to continue regulating in the forward direction only, regardless of power flow direction.

2.2 Short Circuit and Protection Analysis

With the maximum penetration levels of PV identified for each feeder as shown in the previous section, a short circuit analysis was completed using ASPEN and SynerGEE to determine protection impacts.

The existing substation source impedance and fault calculations are presented below in Table 2-11.

**Table 2-11
Source Impedance and Existing Fault Calculations**

Source	Nominal Voltage (kV)	3LG (amps)	1LG (amps)	Positive Sequence (ohms)		Zero Sequence (ohms)	
				R	X	R	X
TSF-H132 Substation	46	2,439	1,652	1.883	10.787	3.619	26.201

Note: Impedance provided in ASPEN Oneliner model without existing PV generation on.

The Company provided information indicating that the micro-inverter is widely used on the Company distribution system for NEM installations and represents typical inverter specifications for fault contribution on the system. The fault contribution, based on inverter manufacturer data, is 1.05 of the continuous current rating, which equates 0.95 amps at 240 volts. The same fault current contribution, 1.05 of the continuous current rating, was applied to each FIT project as well.

Table 2-12 presents the estimated total fault contribution of the NEMS and FIT projects at a 450% increase in NEM penetration, assuming the most limiting case determined from load flows as discussed in Section 2.1. The short circuit calculations at maximum PV penetration levels do not indicate an issue in terms of exceeding protective device interrupting ratings. The Company limit of 5,000 amps, by pole or by feeder essentially, is not expected to be exceeded.

**Table 2-12
Calculated Fault Current at Maximum Penetration Levels**

Location	Nominal Voltage (kV)	All PV Off		PV On		Max Fault Current Contribution from 450% PV growth (amps)
		LLLG (amps)	LG (amps)	LLLG (amps)	LG (amps)	
TSF-H132 Mikilua Substation	12.47	3,383	3,959	3,737	4,379	587.5

Note: Fault current measured at substation low-side bus at 12.47 kV.

In addition, the feeder relay pick-ups are set for 600 amps. Relay pick-ups are not a limiting factor from this analysis based on existing customer load, assuming the inverters will start up later than the load is energized. IEEE 1547 states that there should be a five-minute delay before inverters energize after a system outage scenario.

Tap fuses should be monitored and replaced as PV penetration grows on the distribution. While fault current will increase at fuse locations as PV penetration increases, it appears that the

Section 2

maximum size fuse, 200A, on the H132 feeders should continue to coordinate properly with the circuit relays. In other areas of the distribution system, if a fuse-saving scheme is in place, coordination of that scheme may be impacted and should be evaluated on an individual feeder basis.

Sympathetic or nuisance protective device tripping was also considered. The relays on the H132 circuits are CO overcurrent relays, and they both have the same phase and ground settings without an instantaneous. Leidos ran several simulations to determine if a fault on an adjacent feeder could cause the un-faulted feeder to also trip based on current in the reverse direction. The fault current calculations include the PV contribution with 450% PV growth on the feeders.

Figure 2-12 illustrates the phase and ground relay TCC plots for Circuits H132-1 and H132-2. A fault was placed on the feeder exit of H132-1, and the fault current was measured there as well as at the circuit breaker for H132-2, which is the adjacent circuit in this instance. H132-2 sees 298 amps of three phase-to-ground current in the reverse direction, which is below the phase pick-up. H132-1 breaker sees a 4,379 amp line-to-ground fault and trips around 0.19 seconds. From the TCC, H132-2 sees 327 amps for a line-to-ground fault and should not trip. Generally, 12 cycles or 0.2 seconds of separation for electromechanical relays is sufficient to avoid mis-coordination or mis-operation between relays. In this occurrence, nuisance tripping on H132-2 for a fault on H132-1 should not be an issue.

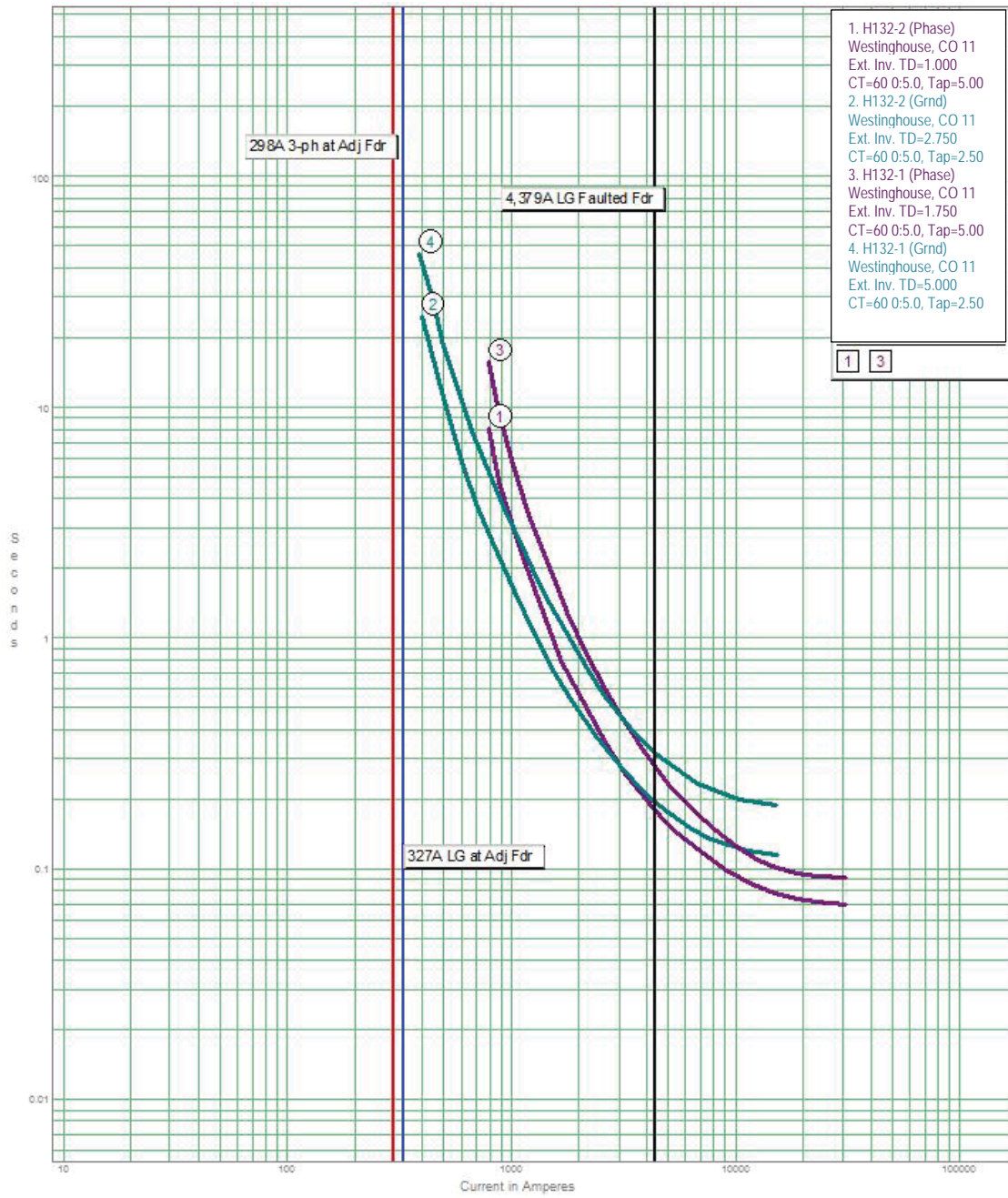

Figure 2-12. Nuisance Tripping-Fault on H132-1 (3-ph and 1-ph); Impact on H132-2

Section 2

2.3 Voltage Flicker

Leidos performed a high-level voltage flicker assessment to determine if an increased level of intermittent DG, such as rooftop solar, could potentially cause irritating voltage fluctuations to the existing customers on the Company distribution system.

Leidos calculated voltage flicker using the steady-state power flow model in SynerGEE to determine the change in voltage when the total amount of PV decreases to no output from full output at peak load day conditions, prior to switchable and tap changing devices on the system adjusting. The percent voltage change was calculated for each modeled element in the SynerGEE model. This assumes the NEMS and FIT projects will respond coincidentally with each other on the two H132 circuits with cloud cover.

For the existing level of NEMS and FIT projects on the two circuits, this approach resulted in a maximum voltage flicker of 6.6% and an average voltage flicker, over the two feeders, of 2.23%. Flicker is less of an issue near the substation or in areas with large conductors to the substation with low impedance.

For the maximum penetration level of 450%, assuming the most limiting case determined from load flows, a maximum voltage flicker of 10.3% and an average voltage flicker of 3.4% was calculated. The increased levels of PV increased potential voltage flicker by 156%.

A voltage flicker of nearly 2.5%, one time per hour, could be noticeable, according to the voltage flicker curve in the IEEE 519 Standard. PV ramps up and down rapidly with cloud movement. With one voltage dip of 10.3% per hour, the IEEE 519 standard flicker chart indicates the voltage dips would irritate the surrounding customers. For reference, see the IEEE 519 flicker chart in Figure 2-13.

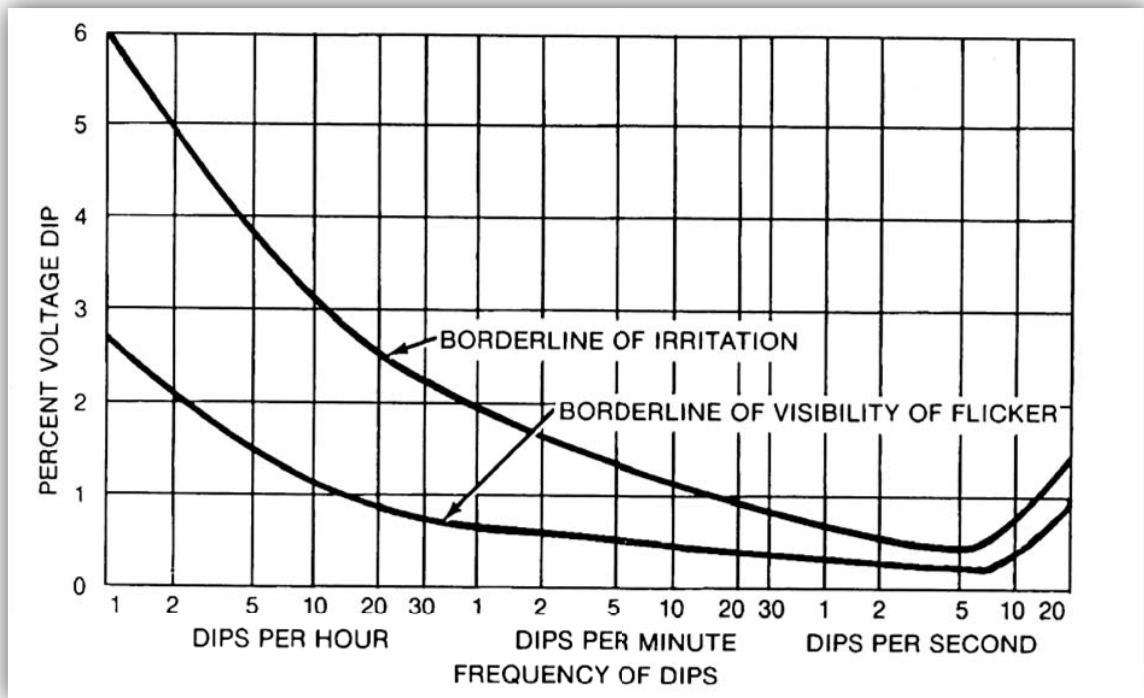

Figure 2-13. IEEE 519 Voltage Flicker Chart

However, the analysis completed in this study is very conservative in assuming all PV panels are facing the same direction and each of the connected PV inverters will swing, simultaneously and frequently, from full output to no output. Further, voltage flicker for PV is not similar to a step-function for a large industrial or motor application as assumed in the IEEE 519 flicker chart. It may not drop out completely and tends to ramp back up rather than respond as a step-function. However, in comparing the existing voltage flicker calculations to potential levels of PV, growing as much as 450%, the Company can see the potential in experiencing much higher voltage flicker levels.

IEC 61000-3-7 superseded the IEEE 519 and IEEE 1453 standards to allow more in-depth discussion of the voltage flicker issue and to include the definition of a flickermeter. IEEE 1453 states that for events that occur once per hour or more, the use of a flickermeter and the subsequent Pst and Plt terms is better suited to characterize the impact than the previous standards. It also states that the previous flicker standards are still useful for infrequent events (less frequent than once per hour).

The results from the high-level flicker assessment indicate that the Company should consider adding monitoring devices on the distribution system where there are high levels of PV penetration to capture short-term and long-term flicker, Pst and Plt, respectively. To form a basis for flicker on the Company system, Leidos recommends starting out monitoring at the feeder level when PV penetration equals feeder load. If there are existing cases of this on the Company system, the Company should measure those to get a base flicker measurement for that level of PV on different types of distribution circuits such as long, short, small wires, all overhead versus

Section 2

underground, etc. As PV penetration grows on the system, the Company will begin to have a recorded baseline of voltage flicker across the system for 100% PV penetration. Based on the IEC standard, Pst should be limited to 0.9 and Plt should be limited to 0.7 for the medium distribution system. Depending on where the baseline measurements fall in comparison the limits, the Company can get an idea of how much room is left on the feeder for additional PV.

As the monitoring devices show Pst and Plt values getting closer to the limits, the Company can either make system upgrades such as conductor or cable upgrades to lessen the impact of voltage flicker, require inverters to operate off unity to reduce the voltage differential when they drop out, install battery storage systems, or restrict additional PV in those areas.

2.4 Load Rejection Transient Overvoltage Evaluation

Leidos built a single-phase inverter model and H132 feeder characteristics in PSCAD to review possible Transient Overvoltage (TOV) issues from load rejection and potential islanding scenarios. The model included substation source impedance and main backbone cable parameters along H132-2. Existing three-phase FIT PV systems were modeled using the PSCAD model provided by the manufacturer. Single-phase taps were added and the single-phase inverters, representing the NEMs, were added downstream of single-phase service transformers. Single-phase residential customer loads were added at the inverter locations and additional single-phase and three-phase customer load was added along the main primary backbone of the circuit. The following figure illustrates the configuration of the model built in PSCAD. The point labeled as “VinVS”, next to the feeder breaker, is the voltage monitoring location for the scenarios evaluated.

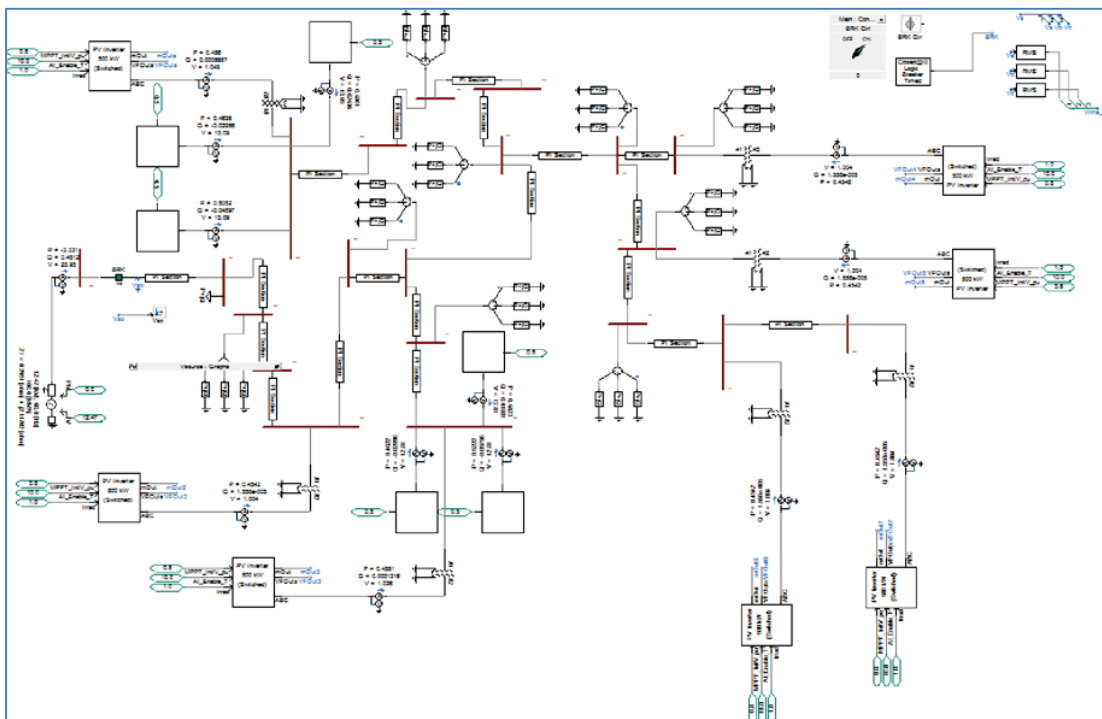

Figure 2-14. PSCAD Model Diagram – Three-phase

The single-phase inverters, representing the NEMs, were modeled with voltage response requirements from IEEE 1547, where the inverter must disconnect in 0.16 seconds or 10 cycles if measured voltage at the interconnection is greater than 120%. Additionally, the inverter has an instantaneous response built in that shuts off the inverter if voltage greater than 155% is measured. Frequency response requirements from IEEE 1547 were also modeled, where the inverters must disconnect in 0.16 seconds or 10 cycles if measured frequency at the interconnection is greater than 60.5 Hertz. Leidos incorporated all three inverter responses into the study.

The following figure represents the internal schematic of each box from Figure 2-15 labeled as either PHASE_A, PHASE_B, or PHASE_C. The boxes include the single-phase taps, service transformers, single-phase customer load, and single-phase inverters.

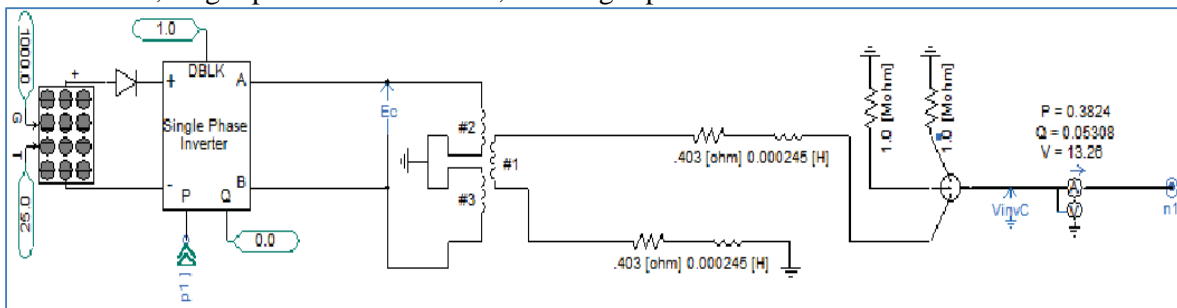

Figure 2-15. PSCAD Model Diagram – Single-phase details

The inverters were modeled as 0.5 MW inverters, which represents a larger quantity of NEMs in an area. The other customer load, on the secondary and primary areas of the circuit, varied in each scenarios evaluated. The customer load was modeled assuming a 98% power factor, which is in line with load data provided by the Company.

Section 2

The following load rejection scenarios were evaluated.

- Scenario 1 – 100% DML
- Scenario 2 – 120% DML
- Scenario 3 – 150% DML
- Scenario 4 – 200% DML
- Scenario 5 – 300% DML
- Scenario 6 – 400% DML

2.4.1 TOV Results

For each scenario, Leidos simulated when the feeder breaker opens at 1 second into the simulation. The inverters include frequency and voltage trip settings based on IEEE 1547 requirements and the fast trip voltage setting of 155% based on the inverter. The results were compared to the ITI (CBEMA) Curve, which limits various levels of high voltage over time to prevent 120-volt customer equipment from damage. See Figure 2-16.

The CBEMA Curve shows that voltages greater than 120% cannot last longer than 3 milliseconds. Voltages less than 120% can continue up to 0.5 seconds. Voltages less than 110% can continue beyond that up to steady-state conditions.

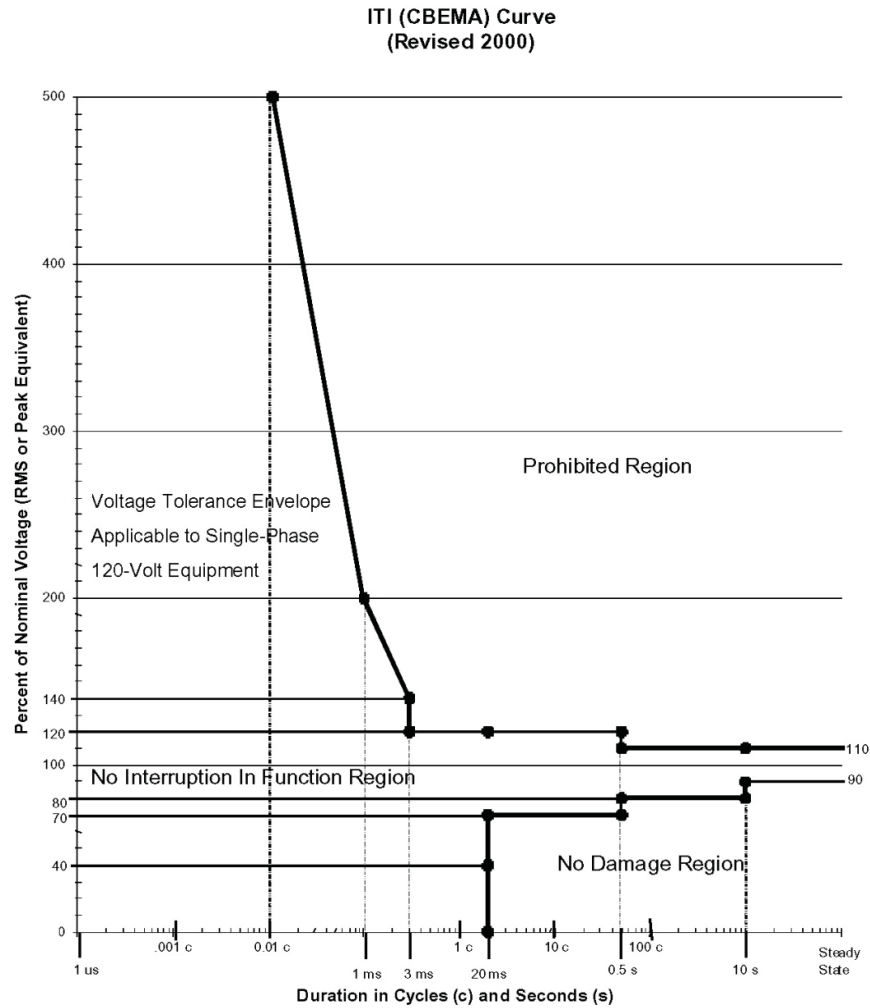

Figure 2-16. ITI (CBEMA) Curve

The following table summarizes the results of the scenarios evaluated. The results show the duration of the maximum voltage recorded, the magnitude of the largest voltage spike, the longest lasting magnitude and duration of that magnitude, and if the results meet ITIC. Up until Scenario 6, the inverter side voltage did not reach the 155% voltage instantaneous trigger.

Section 2

Table 2-10
TOV Results by Scenario

Scenario	Description	TOV Magnitude	TOV Duration (milliseconds)	Max TOV Magnitude	Max TOV Duration (milliseconds)	Meets ITIC
Scenario 1	100% DML	65%	160	104%	<0.1	YES
Scenario 2	120% DML	75%	160	114%	<0.1	YES
Scenario 3	150% DML	95%	160	133%	<0.1	YES
Scenario 4	200% DML	100%	160	142%	<0.1	YES
Scenario 5	300% DML	120%	160	146%	<0.1	NO
Scenario 6	400% DML	>120%	3.6	147%	<0.1	NO

Note: Voltage spikes measured on primary distribution system adjacent to the circuit breaker.

1. In Scenario 3, TOV was greater than 120% for 2.0 milliseconds.
2. In Scenario 4, TOV was greater than 120% for 2.1 milliseconds.
3. In Scenario 6, the instantaneous voltage fast trip responded.

The results show that a PV to minimum load penetration of 200% is achievable without causing concern for overvoltage. Scenario 6, where the 155% voltage fast trip was triggered, results in TOV for 147% for less than 0.1 milliseconds, and the duration of voltage, greater than 120%, is 3.6 milliseconds, which is an ITIC violation. The analysis shows that even if the connected inverters do not have the fast/instantaneous trip, overvoltages in relation to the CBEMA curve are not a concern at 200% penetration. The frequency trip setting is the trigger for the scenarios up until Scenario 6.

The following figures, with results, will help further explain the findings. The X-axis is seconds and the Y-axis is actual voltage in kV for the voltage charts and W (radians/second) for the frequency charts. The charts include voltage measured on the three-phase primary distribution system near the feeder breaker and voltage measured on the secondary system at a FIT inverter location.

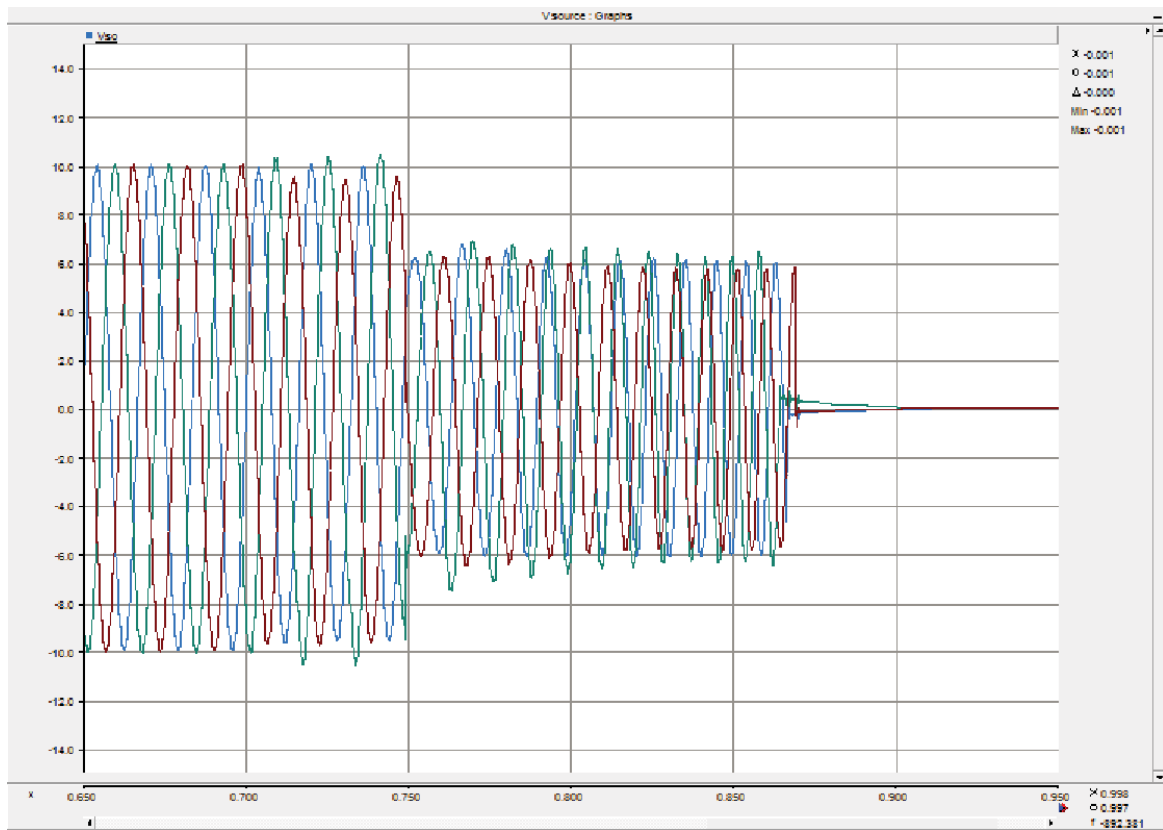

Figure 2-17. Scenario 1 – Primary Voltage

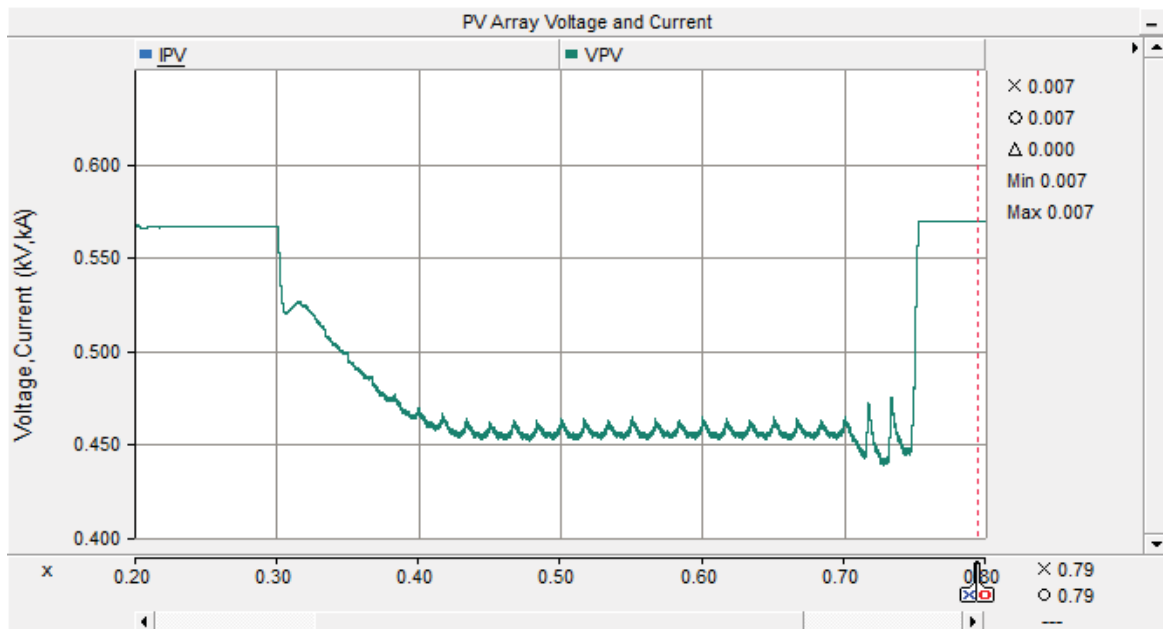

Figure 2-18. Scenario 1 – Secondary Voltage

Section 2

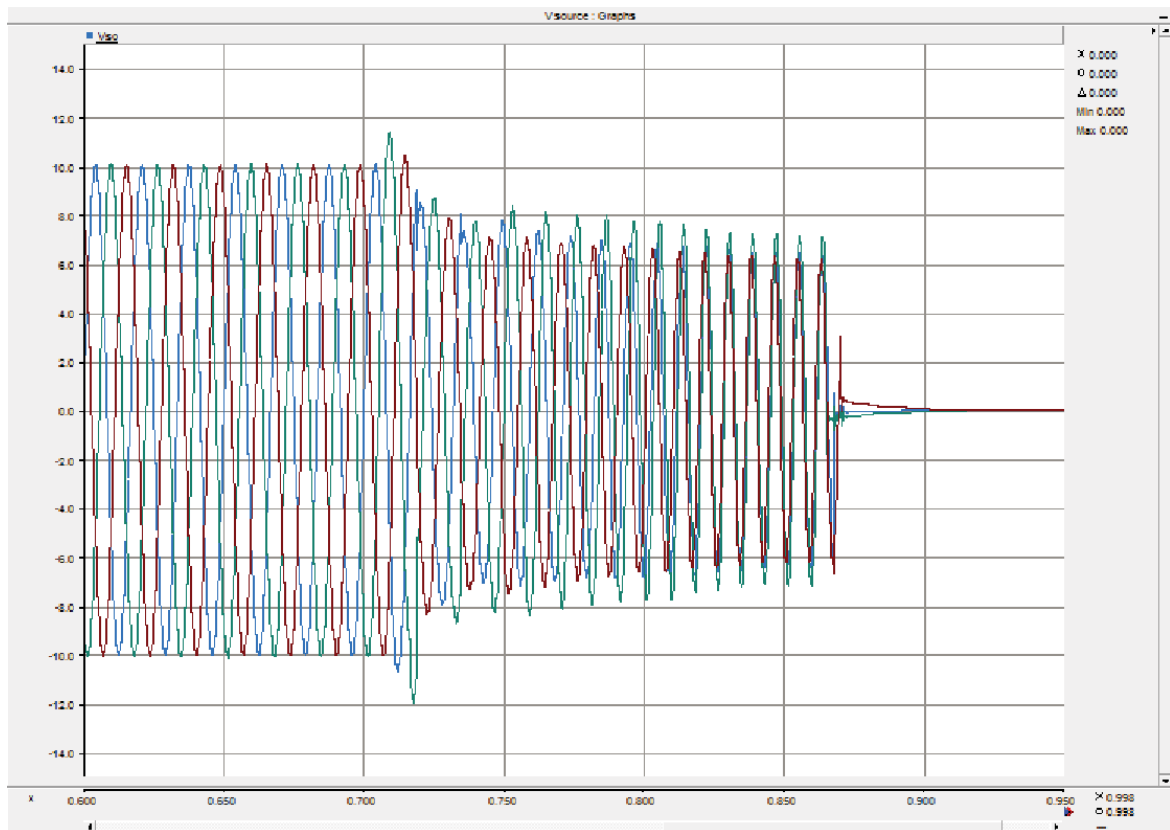

Figure 2-19. Scenario 2 – Primary Voltage

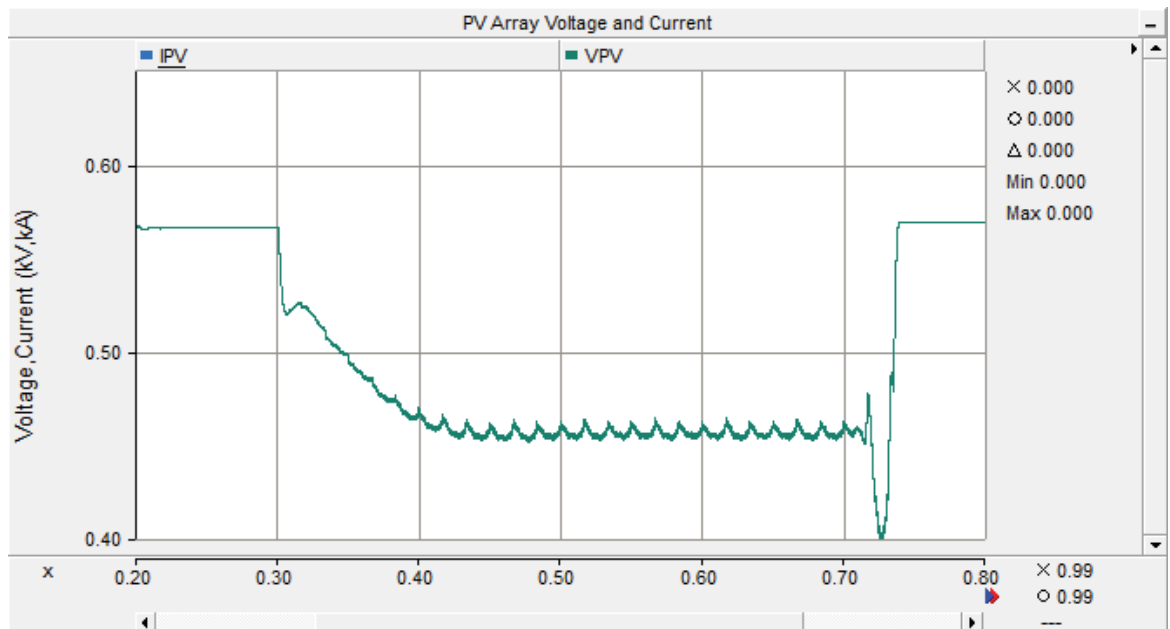

Figure 2-20. Scenario 2 – Secondary Voltage

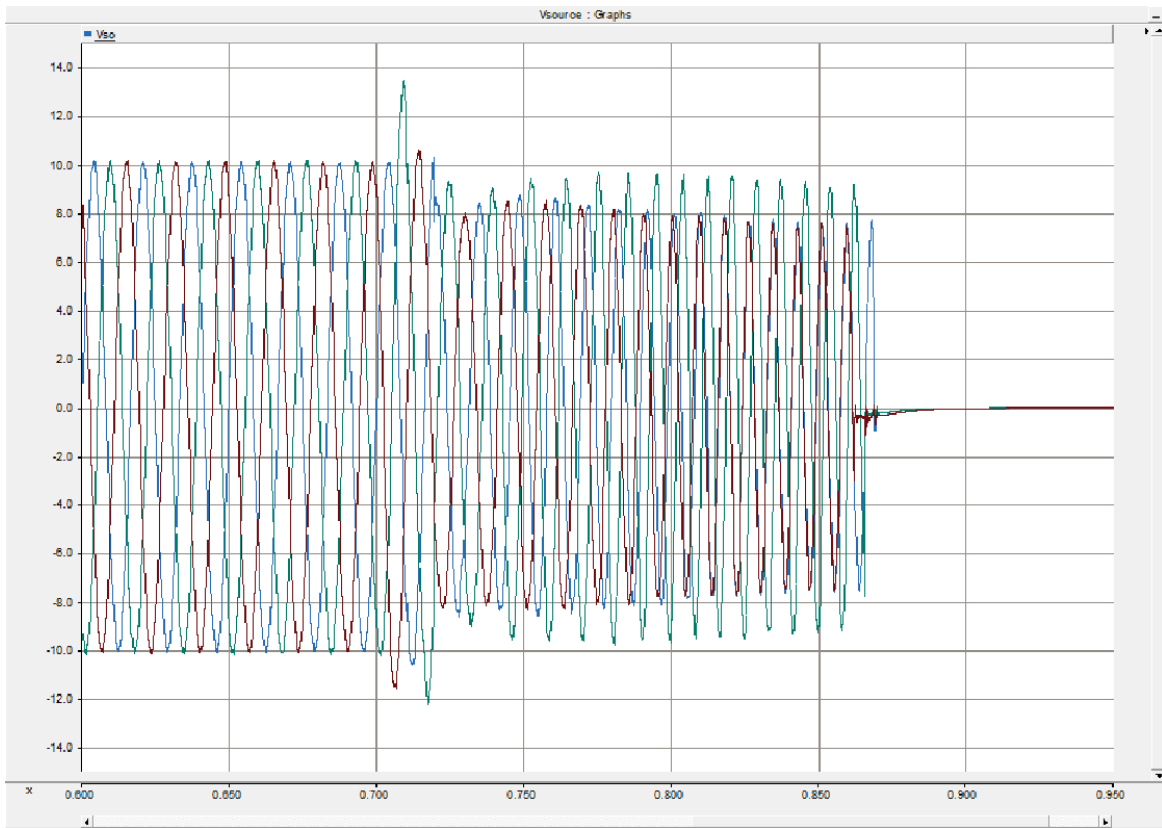

Figure 2-21. Scenario 3 – Primary Voltage

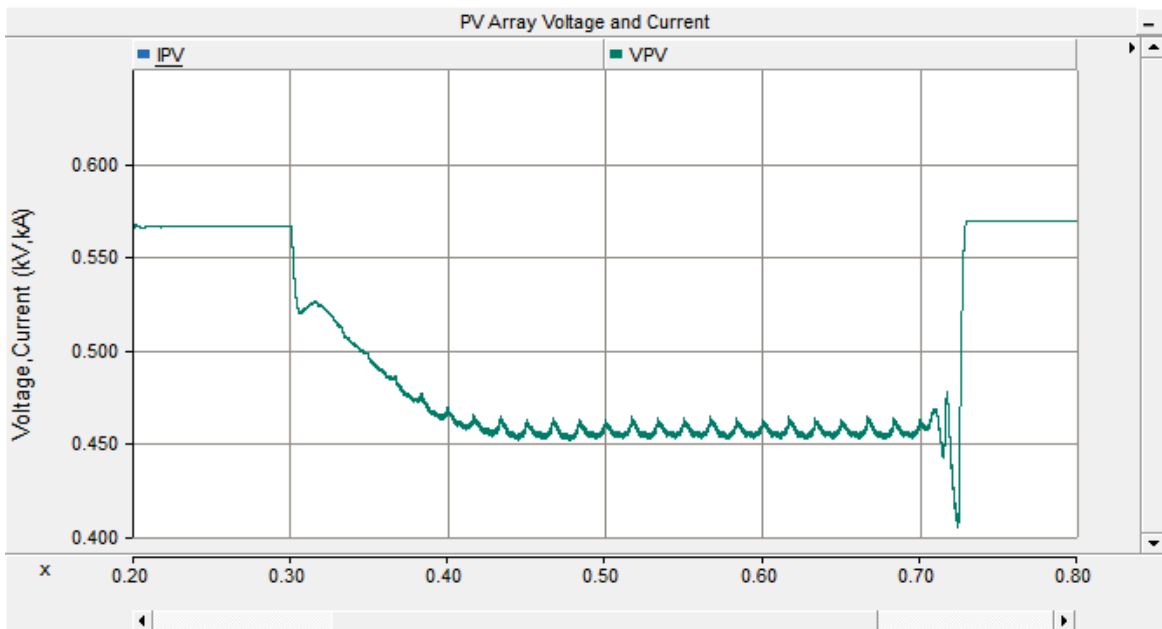

Figure 2-22. Scenario 3 – Secondary Voltage

Section 2

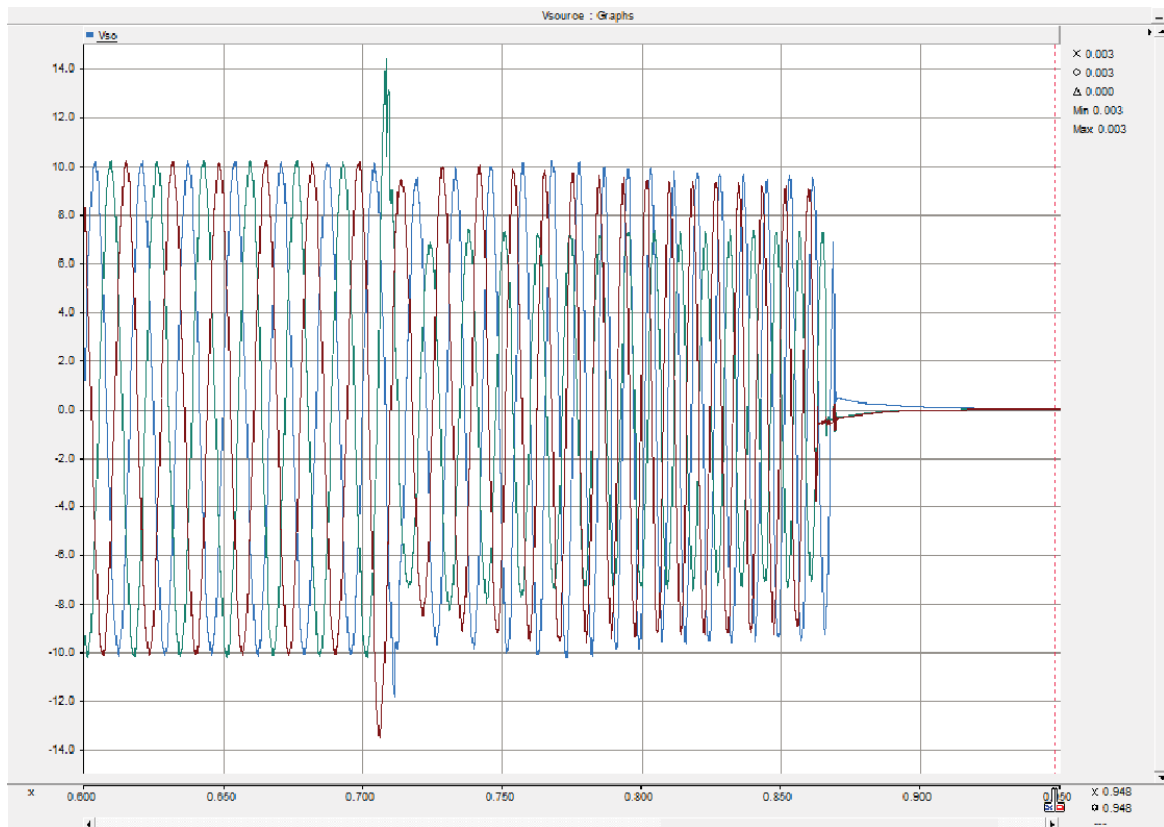

Figure 2-23. Scenario 4 – Primary Voltage

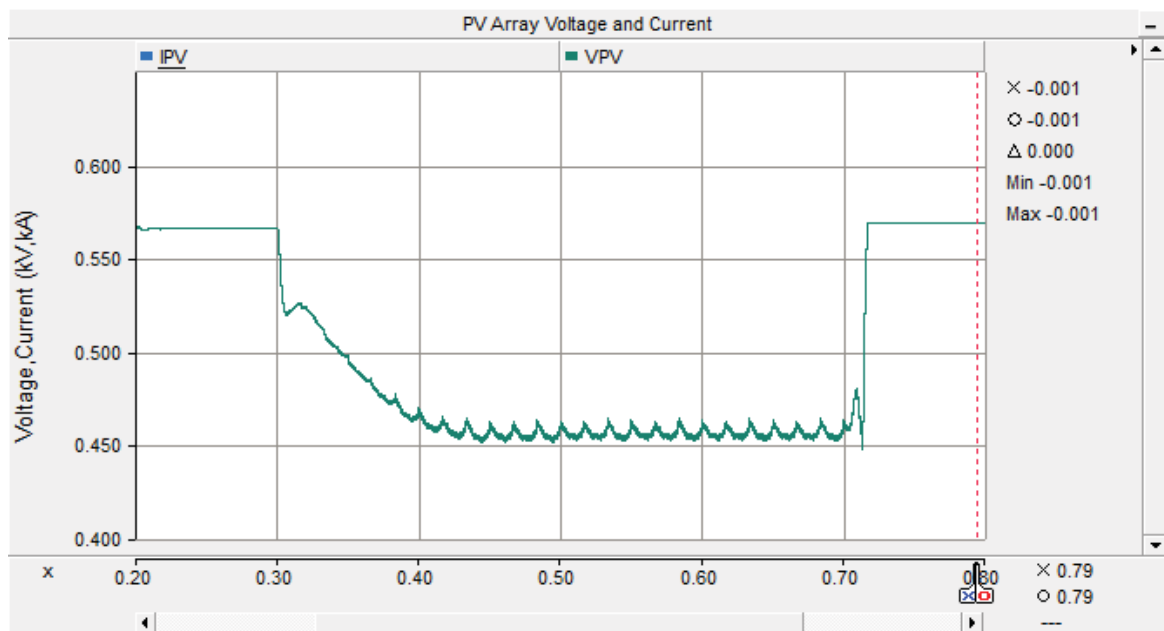

Figure 2-24. Scenario 4 – Secondary Voltage

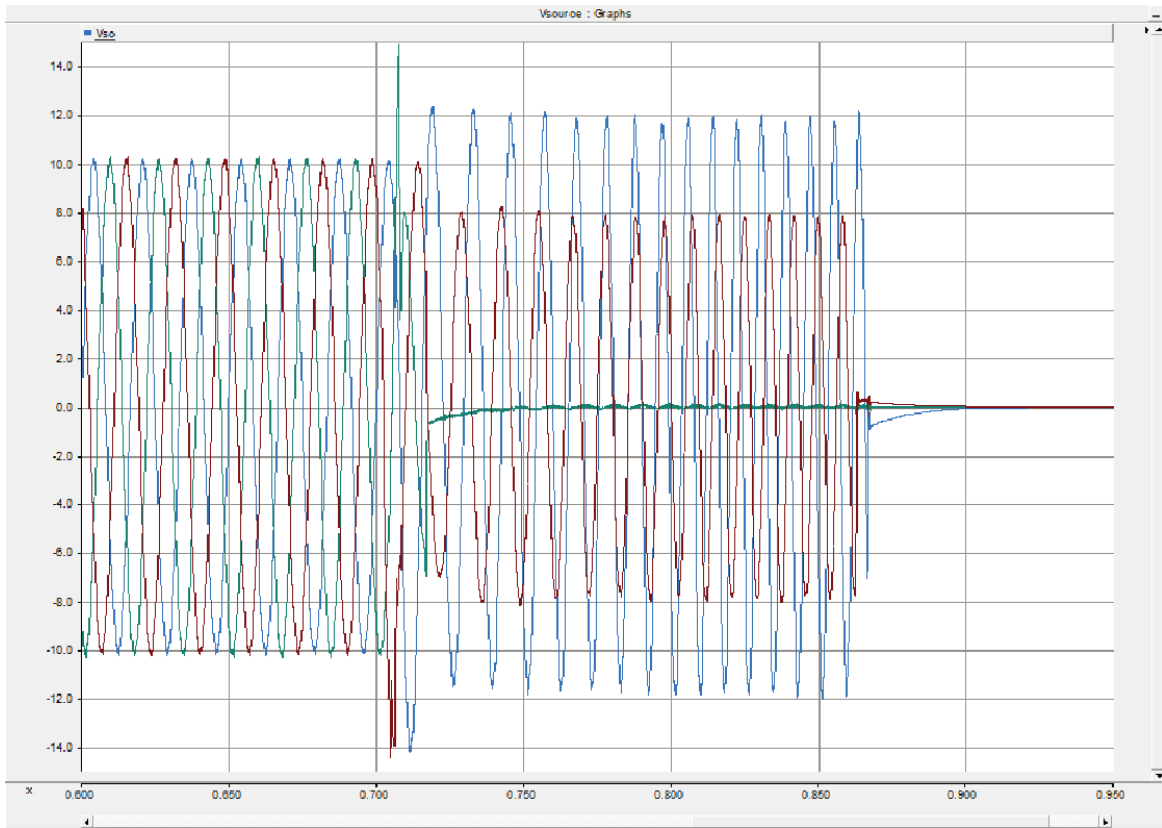

Figure 2-25. Scenario 5 – Primary Voltage

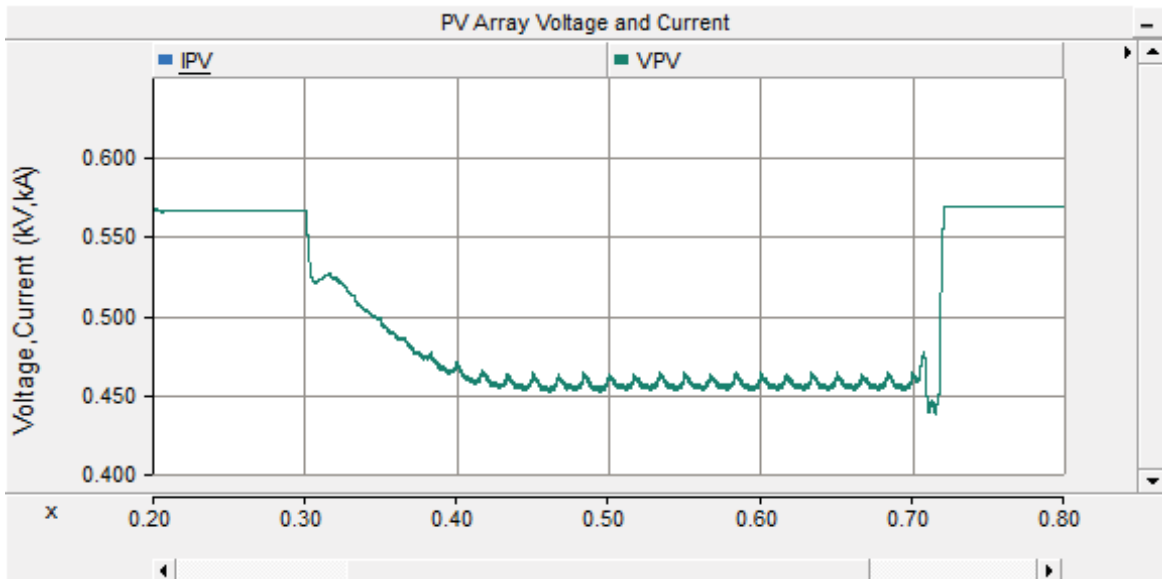

Figure 2-26. Scenario 5 – Secondary Voltage

Section 2

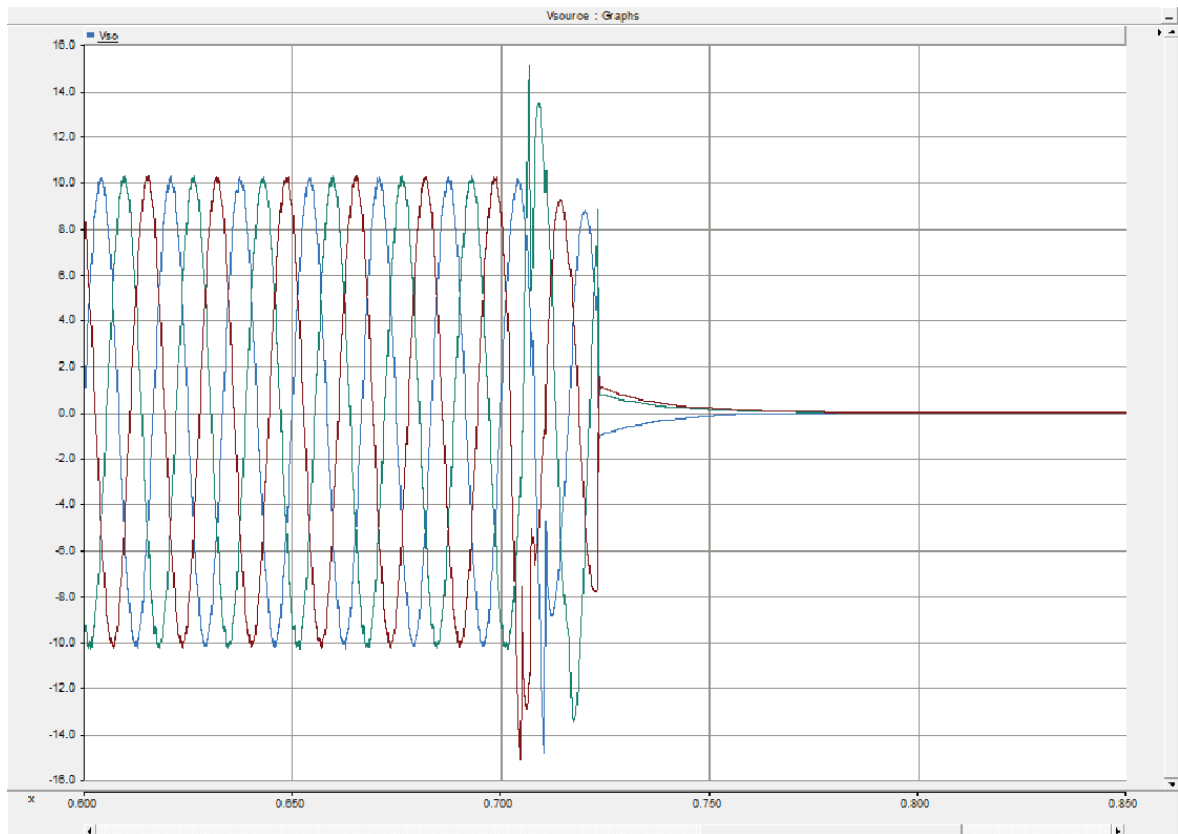

Figure 2-27. Scenario 6 – Primary Voltage

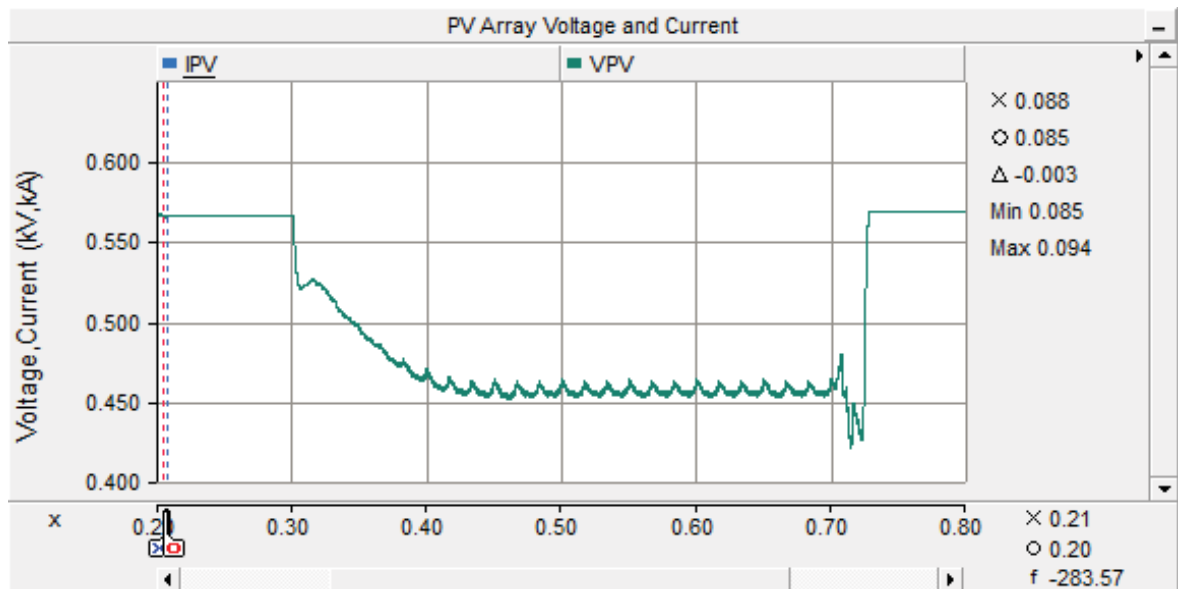

Figure 2-28. Scenario 6 – Secondary Voltage

The results indicate that frequency is the driver for the inverters shutting off in the event of a feeder outage event. For each case, frequency is greater than 60.5 Hz, which signals for the IEEE 1547 certified inverters to shut off in 0.16 seconds or 10 cycles. The exception is Scenario 6, where the inverters have the fast trip technology and are offline much sooner than 10 cycles.

Penetration levels at 200% to minimum load appear to be the limit. If the Company is interested in penetration levels greater than this, requiring inverters with fast trip technology for voltage, lower than 155%, would help alleviate overvoltage concerns at higher penetration levels. Also, automatic transfer switches at customer homes with NEM PV could take the PV offline more quickly at higher penetration levels, especially for inverters without the fast trip technology.

Prior to implementing changes in policy or system operating procedures based on these results, Leidos recommends that the Company install voltage monitoring on the load side of several feeder breakers with high PV penetration to capture voltage spikes in actual load rejection scenarios. In the industry, there is not an abundance of measurements or simulations of TOV for high penetrations of NEM PV. Verifying or closely matching the results from this study could further justify any major changes the Company may pursue based on TOV concerns.

This page intentionally left blank.

Section 3

SUMMARY AND RECOMMENDATIONS

The circuit penetration study for the H132 circuits indicate that minimum load conditions identify the maximum allowable penetration of PV. More primary and secondary conductor/cable upgrades and service transformer upgrades will be required with PV growth on the distribution system. Additional monitoring locations on the distribution feeder to calculate short-term and long-term flicker values, Pst and Plt, are recommended to be pro-active in mitigating voltage flicker issues as PV installations increase on the system.

The limitation on the distribution system is associated with load rejection overvoltage from high NEM PV penetration levels in addition to FIT PV penetration. The TOV analysis indicates that without mitigation, levels of NEM and FIT PV penetration on distribution feeders can reach 200% penetration. Beyond that, mitigation strategies could include requiring inverters to have fast trip functionality lower than 155% or installing automatic transfer switches at NEM PV locations to trip them off-line faster than the inverter internal programmed response. Leidos recommends measuring voltages from actual load rejection events to compare to the results of the study, which will further justify any Company policy changes or system operating procedures.

Additional Considerations

The Company requested that Leidos model the capabilities of selected distribution feeders to accommodate NEM PV. To understand the systemic implications of the solar back-feed and variability at the distribution level, the Company should incorporate these results into a system-level model considering transmission system reliability (congestion issues, outage issues, circuit upgrade requirements, etc.) and generation concerns (stability and dispatch issues), including the utility scale solar and wind projects. The Company should consider taking a more comprehensive view of the effect that increased levels of intermittent renewable penetration can have on stability, ramp capability, or unit startup time. A holistic approach is the only way to understand fully what measures should be taken to:

- Maintain stability
- Minimize additional O&M (due to potential increases in generator cycling and lower efficiencies from operating at reduced load levels during peak renewable output periods)
- Implement curtailment structures
- Augment new utility scale PPAs with additional interconnection requirements
- Optimize installation of energy storage
- Provide solutions to mitigate increased utility operations cost while providing reliable service

Synchronous Condensers (SC) may be required to provide voltage and inertia support not received from the renewables. The Company should consider installing Synchronous Condenser (SC) at specific locations, which would be determined from further studies.

Section 3

Energy storage is a viable option, but due to the cost, the Company should perform studies to optimize the location and sizing of energy storage systems to maximize the effectiveness of this solution. Battery storage at substations or utility scale renewable installations can address ramp capability and unit startup time. Further analysis needs to be done to determine if battery storage would be able to provide MW support in case of a fast solar declamation, for instance 320 MW in 30 minutes. Installation of fast start units can also provide inertia and voltage support, as well as fast ramp and startup capabilities.

A combination of SC, battery storage, and fast start units may be the most reliable and economic option. Other possibilities are DC submarine cable ties between the islands, geothermal storage, or curtailment of renewable generation, even rooftop PV, by remote control or installation limits. The Company should perform studies and implement demonstration projects of viable options.

The Company will also still need to have enough spinning reserve in order to meet its requirement for the loss of the Most Severe Single Contingency (MSSC). AES is the Company's biggest unit (201 MW) and is online most of the time due to cost; therefore, loss of the AES unit is typically the MSSC. However, if the unit is not online for any reason, the Company's MSSC will be Kahe-6 or Kahe-05, which are around 142 MW each.

In Leidos experience with other island electrical systems, integrating renewables requires this type of complete approach and the Company may find it advantageous to assess the generation profiles of the assets in the fleet as flexible ramping capability becomes more critical at high penetration levels. Additionally, as the Company is aware, conversion from oil fired to natural gas generation is an effective way to reduce generation costs (in conjunction with potentially implementing generator replacements to increase efficiency of older units). For example, in Puerto Rico, recent studies have shown that at high penetration levels (in Puerto Rico's case there is a significant amount of renewable capacity coming online at the transmission level) generation costs can increase to accommodate the variability of renewables.

In summary, an exponential increase in the adoption of distributed solar generating systems can lead to a number of challenges, including reliability issues, cost shifts, and congestion on the grid. In addition to the technical impacts, significant PV penetration could increase the cost of service to the Company and non-PV customers due to mitigation costs, reduced revenue from Net Energy Meters to fund required infrastructure, and the reduced heat rate and increased O&M of existing generators running below minimum load levels. Leidos recommends a holistic approach that considers rates and the economic in addition to technical impacts of increased PV on the transmission system and existing generators as well as the distribution system and substations. This should include developing a methodology to quantify the market value of solar generation to the Company, given the unique characteristics of an island grid.

Final Report

TSF-H158 & TSF-H159
Circuit Penetration Study

Hawaiian Electric Company

August 2014



This page intentionally left blank.

Final Report

TSF-H158 & TSF-H159
Circuit Penetration Study

Hawaiian Electric Company

August 2014



This report has been prepared for the use of the client for the specific purposes identified in the report. The conclusions, observations and recommendations contained herein attributed to Leidos constitute the opinions of Leidos. To the extent that statements, information and opinions provided by the client or others have been used in the preparation of this report, Leidos has relied upon the same to be accurate, and for which no assurances are intended and no representations or warranties are made. Leidos makes no certification and gives no assurances except as explicitly set forth in this report.

© 2014 Leidos, Inc.
All rights reserved.

TSF-H158 & TSF-H159 Circuit Penetration Study

Hawaiian Electric Company

Table of Contents

Executive Summary

Section 1 METHODOLOGY	1-1
1.1 Introduction.....	1-1
1.2 Software Application Tools.....	1-2
1.3 Basic Data and Assumptions	1-2
Section 2 STUDY RESULTS	2-1
2.1 Thermal Loading and Voltage	2-1
2.1.1 Secondary Voltage Level Analysis.....	2-7
2.1.2 Impact on Load Tap Changers.....	2-9
2.2 Short Circuit and Protection Analysis	2-10
2.3 Voltage Flicker	2-13
2.4 Load Rejection Transient Overvoltage Evaluation.....	2-15
2.4.1 TOV Results	2-17
2.5 Extrapolation of Results to Company Distribution System.....	2-27
Section 3 SUMMARY AND RECOMMENDATIONS	3-1

List of Tables

Table ES-1 Existing NEM Penetration	ES-1
Table 1-1 Existing NEM Penetration.....	1-1
Table 2-1 Existing System Results at Peak Daytime Loading	2-1
Table 2-2 Existing System Results at Minimum Daytime Loading	2-1
Table 2-3 Maximum % PV Growth Identified By Feeder.....	2-2
Table 2-4 Maximum % PV Growth Identified by Substation Transformer	2-2
Table 2-5 Maximum PV Growth Results at Peak Daytime Loading.....	2-3
Table 2-6 Maximum PV Growth Results at Minimum Daytime Loading	2-5
Table 2-7 Impact on LTC Movement	2-9
Table 2-8 Source Impedance and Existing Fault Calculations	2-10
Table 2-9 Calculated Fault Current at Maximum Penetration Levels	2-11
Table 2-10 TOV Results by Scenario	2-19

List of Figures

Figure ES-1. TSF-H158 & TSF-H159 Circuit Overview.....	ES-2
Figure 2-1. Peak Load Scenario – Maximum PV Growth Scenario – Color by Voltage	2-3
Figure 2-2. Peak Load Scenario – Maximum PV Growth Scenario – Color by Conductor Loading.....	2-4

Table of Contents

Figure 2-3. Min Load Scenario – Maximum PV Growth Scenario – Color by Voltage 2-5
Figure 2-4. Min Load Scenario – Maximum PV Growth Scenario – Color by Conductor..... 2-6
Figure 2-5. Example of Secondary Line Voltage Calculation under Existing Conditions..... 2-7
Figure 2-6. Second Example of Secondary Line Voltage Calculation at Increased
PV Penetration..... 2-8
Figure 2-7. Nuisance Tripping-Fault on H159-1 (3-ph); Impact on H159-2..... 2-12
Figure 2-8. Nuisance Tripping-Fault on H159-1 (1-ph); Impact on H159-2..... 2-13
Figure 2-9. IEEE 519 Voltage Flicker Chart 2-14
Figure 2-10. PSCAD Model Diagram – Three-phase..... 2-16
Figure 2-11. PSCAD Model Diagram – Single-phase details 2-16
Figure 2-12. ITI (CBEMA) Curve 2-18
Figure 2-13. Scenario 1 - Primary Voltage..... 2-20
Figure 2-14. Scenario 1 – Secondary Voltage 2-20
Figure 2-15. Scenario 2 – Primary Voltage 2-21
Figure 2-16. Scenario 2 - Secondary Voltage..... 2-21
Figure 2-17. Scenario 3 – Primary Voltage 2-22
Figure 2-18. Scenario 3 – Secondary Voltage 2-22
Figure 2-19. Scenario 4 – Primary Voltage 2-23
Figure 2-20. Scenario 4 – Secondary Voltage 2-23
Figure 2-21. Scenario 5 – Primary Voltage 2-24
Figure 2-22. Scenario 5 – Secondary Voltage 2-24
Figure 2-23. Scenario 6 – Primary Voltage 2-25
Figure 2-24. Scenario 6 – Secondary Voltage 2-25
Figure 2-25. Scenario 7 – Primary Voltage 2-26
Figure 2-26. Scenario 7 – Secondary Voltage 2-26
Figure 2-27. Comparison of Voltage Impacts with Variations in Circuit Impedance
Strengths..... 2-28

EXECUTIVE SUMMARY

Introduction

Leidos Engineering, LLC (Leidos) has completed the TSF-H158 and TSF-H159 Circuit Penetration Study for Hawaiian Electric Company (Company) to determine maximum penetration levels of rooftop distributed solar on the four 12.47 kV feeders served from those transformers. The analysis is intended to not only determine saturation levels for that particular area of the system, but also be extrapolated to represent saturation levels on other similar areas of the Company distribution system.

The following table presents existing levels of Net Energy Metering (NEM), rooftop solar installations on the four circuits.

Table ES-1
Existing NEM Penetration

Circuit	Minimum Daytime Load (kW)	NEM (kW)	Percent Penetration NEM to Min Load
H158-1	1,540	961	62%
H159-1	306	285	93%
H159-2	2,130	2,784	130%
H158-2	3,286	2,739	83%

Figure ES-1 shows the geographic representation of the four H158 and H159 circuits.

EXECUTIVE SUMMARY

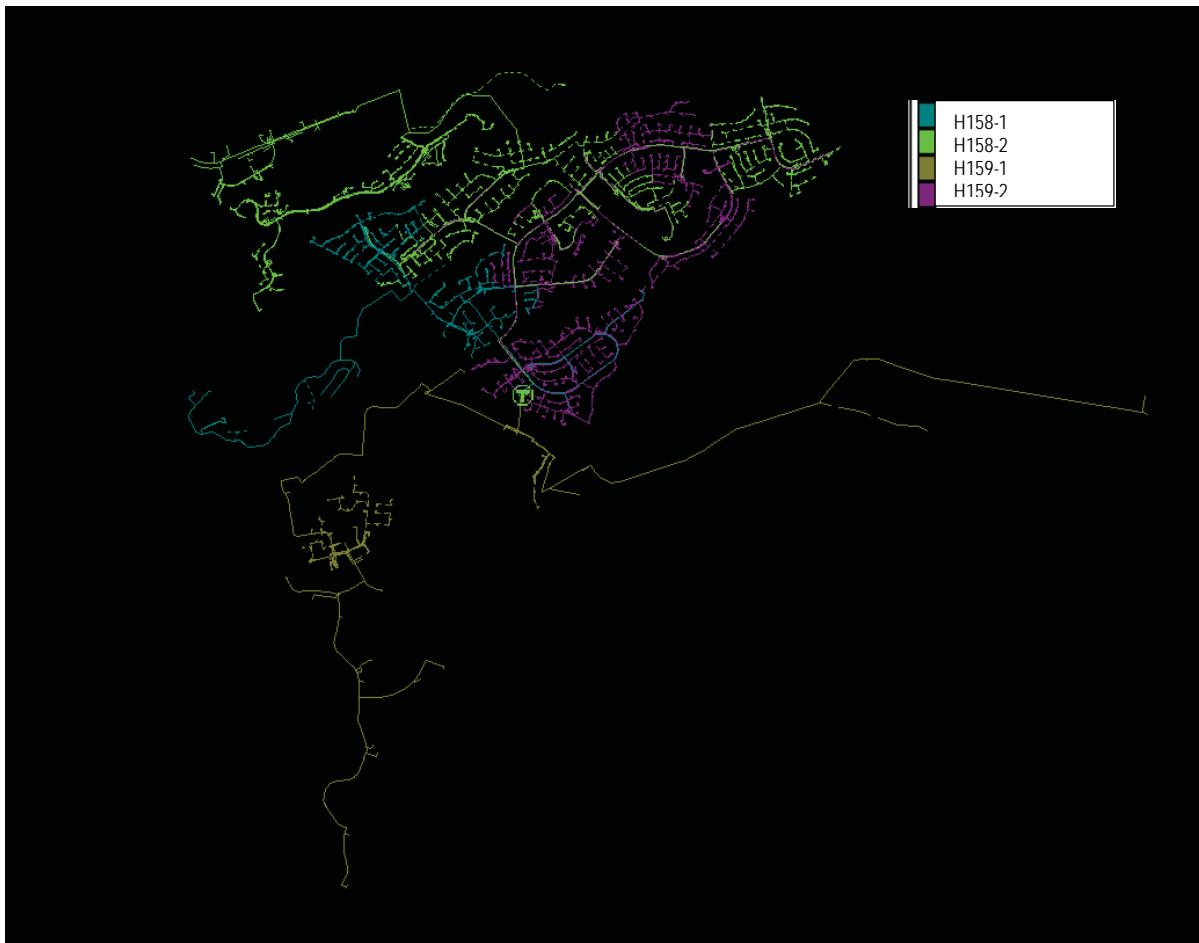

Figure ES-1. TSF-H158 & TSF-H159 Circuit Overview

This report summarizes details of the analysis and findings of the circuit penetration study. The study included a review of short circuit, voltage, capacity, voltage flicker, transient overvoltage, and other impacts. Criteria violations were determined based on Company standards.

Summary of Findings

The analysis, including a voltage and capacity review, short circuit and protection review, high-level voltage flicker analysis, and transient overvoltage analysis, reveals the following.

- The voltage and capacity review indicates:
 - PV growth, beyond the existing level of NEMS on the H158 and H159 circuits, can reach 400% without reaching hard limits defined in the study. This equates to 27 MW of interconnected NEMs, which is 371% of the minimum load served from the H158 and H159 circuits. The existing level is 6.7 MW for the H158 and H159 circuits, which is 92% of the minimum load.
 - Upgrades to primary distribution lines to alleviate capacity and high voltage should be expected as PV installations grow on the distribution system.
 - None of the service transformers on the H158 and H159 circuits are over capacity at existing minimum loading. However, with growth of PV by 400%, the study found 280 service transformers could be over capacity.
 - Prior to growth of PV by 400% or 371% DML for the H158 and H159 circuits, primary conductors exceed 50% thermal capacity.
 - Higher voltage on the secondary lines with PV growth could require more conductor/cable upgrades on the secondary system than on the primary distribution system.
 - In contingency conditions, where the Company relies on distribution feeder ties, increased PV penetration could impact available tie capacity. For tie feeders with more load than PV, switching capacity should be available to feeders with heavy PV penetration because the PV will absorb the load, which typically relieves capacity. For tie feeders with more PV than load, switching capacity will be limited to tie to a feeder with a similar heavy PV penetration. On a by-feeder basis, reverse flow should be monitored and considered when tying circuits together in a contingency. If there are not multiple feeder tie options for some areas of the Company system and increased levels of PV create difficulties in contingency switching, the Company could consider requiring PV to be offline under contingency situations. If requiring the PV offline under contingency situations is not plausible, the Company should limit reverse flow to 50% in order to maintain normal traditional planning and operational flexibility.
 - Excessive substation transformer load tap changer (LTC) movement is not expected to be an issue for the TSF-H158 and TSF-H159 transformers and the circuits they serve. The current LTC settings are acceptable for this substation as well. For other areas of the Company distribution system, if feeders have a larger bandwidth of voltage measurements, the Company may consider adding line voltage regulators to reduce feeder voltage bandwidth or consider alternative LTC settings, where it continues to regulate in the forward position, even in reverse flow conditions, which is referred to as co-generation

EXECUTIVE SUMMARY

mode. Leidos recommends co-generation model for voltage regulators on the distribution feeders.

- The short circuit and protection review revealed the 400% growth of NEMS should not be a concern related to feeder relay interrupting ratings. In addition, sympathetic or nuisance trips on relays are not expected to be an issue for feeders that do not have a low-set instantaneous or mid-line protective devices. Tap fuses will need to be replaced/upgraded as loading on taps increases with additional PV growth.
- The high-level voltage flicker evaluation indicates that voltage flicker concerns could increase as PV penetration increases. The Company should consider adding monitoring devices on the distribution system where there are high levels of PV penetration to capture short-term and long-term flicker, Pst and Plt, respectively. Pst should be limited to 0.9 and Plt should be limited to 0.7 for the medium distribution system based on the IEC 61000-3-7 standard. As the monitoring devices show Pst and Plt values getting closer to these limits, the Company can either make system upgrades such as conductor or cable upgrades to lessen the impact of voltage flicker, require inverters to operate off unity to reduce the voltage differential when they drop out, install battery storage systems, or restrict additional PV in those areas.
- The Transient Overvoltage (TOV) analysis indicates that without mitigation, levels of NEM PV penetration on distribution feeders can reach 140% penetration. Beyond that, mitigation strategies could include requiring inverters to have fast trip functionality or installing automatic transfer switches at NEM PV locations to trip them off-line fast than the inverter internal programmed response. Leidos recommends measuring voltages from actual load rejection events to compare to the results of the study, which will further justify any Company policy changes or system operating procedures.

Overall, the H158 and H159 circuits have very strong backbone conductor/cable sizes, which allow more PV penetration in the area. In other areas of the Company system, where there are smaller wire sizes, PV growth may be limited more due to voltage, capacity, and voltage flicker. TOV is the limiting factor for this study, suggesting that PV penetration levels should be limited to 140% of minimum feeder loads.

Additional Considerations

This study does not consider issues on the transmission system or existing generators (including utility scale solar and wind projects) such as stability, ramp capability or unit startup time. To meet stability requirements, Synchronous Condensers (SC) may be required to provide voltage and inertia support not received from the renewables. Battery storage at substations or utility scale renewable installations can address ramp capability and unit startup time. Fast start units can also bring inertia and voltage support, as well as fast ramp and startup capabilities.

A combination of SC, battery storage and fast start units may be the most reliable and economic option. Other possibilities are DC submarine cable ties between the islands, geothermal storage, or curtailment of renewable generation, even rooftop PV, by remote control or installation limits. The Company will still need to have enough spinning reserve in order to meet its requirement for the loss of the Most Severe Single Contingency (MSSC). Conversion from oil to natural gas when replacing older units for increased efficiency may reduce costs.

EXECUTIVE SUMMARY

In addition to the technical impacts, significant PV penetration could increase the cost of service to the Company and non-PV customers due to mitigation costs, reduced revenue from Net Energy Meters to fund required infrastructure and the reduced heat rate and increased O&M of existing generators running below minimum load levels. Leidos recommends a holistic approach that considers rates and the economic as well as technical impacts of increased PV on the transmission system and existing generators as well as the distribution system and substations. The Company should perform studies and implement demonstration projects of viable options.

This page intentionally left blank.

Section 1 METHODOLOGY

1.1 Introduction

The Circuit Penetration Study was performed on the four H158 and H159 circuits served from the TSF-H158 and TSF-H159 transformers, both of which are 46-12.47 kV, 10/12.5 MVA. TSF-H158 serves H158-1 and H158-2, and TSF-H159 serves H159-1 and H159-2. There is approximately 6.7 MW of NEM, rooftop solar installations on the four circuits. Existing penetration levels are shown below in Table 1-1.

**Table 1-1
Existing NEM Penetration**

Circuit	Maximum Daytime Load (kW)	Power Factor at Max Load	Minimum Daytime Load (kW)	Power Factor at Min Load	NEM (kW)	Percent Penetration NEM to Min Load
H158-1	3,662	99.8%	1,540	99.9%	961	62%
H159-1	1,090	99.9%	306	98.1%	285	93%
H159-2	5,254	99.9%	2,130	98.1%	2,784	130%
H158-2	7,086	99.8%	3,286	99.9%	2,739	83%

The NEM installations were modeled in SynerGEE as spot loads, primarily. The Company did identify 82 locations where specific service transformers and PV generation facilities were modeled explicitly. This allowed Leidos to determine if modeling the detailed components for the SynerGEE steady-state analysis would make an impact on the results in those areas differently than other areas of the system where PV was modeled as spot loads.

For determining when saturation limits would arise from increasing PV penetration, the Company and Leidos worked together to determine system limitations.

Hard limits, defined as issues that arise that would not be addressed through a system improvement to accommodate additional NEMs, include:

- Substation transformer loading – 10 MVA for each transformer
- Underground exits for each circuit – these are already 1000 AL or 750 CU, which are the largest sizes the Company utilizes

Operational limits, defined as issues that arise that could be addressed through a system improvement to accommodate additional NEMs, include:

- Conductor/cable loading on the feeder where the maximum size utilized by the Company is not in use
- Minor high or low voltage
- Replacement of equipment such as regulators or protective devices due to capacity or reverse flow limitations

Section 1

Leidos increased existing penetration levels, using SynerGEE, to evaluate voltage and capacity on the four H158 and H159 circuits. Initially each feeder was analyzed individually at maximum and minimum daytime load scenarios to determine maximum penetration levels based on hard limits for the feeder. When feeder hard limits were identified, PV penetration was increased, simultaneously, on both feeders served from a substation transformer to determine if a substation transformer hard limit would be reached sooner than on an individual feeder basis.

Upon identifying the maximum penetration levels, short circuit analysis was completed to determine the impact on protection at those levels. Also, a high-level voltage flicker assessment was completed. Impacts from the maximum penetration level of PV on transient overvoltage (TOV) was also investigated.

1.2 Software Application Tools

The study was completed using SynerGEE, ASPEN, and PSCAD software. SynerGEE was used for the voltage and capacity evaluation; ASPEN was used for short circuit and protection analysis; and PSCAD was used for the TOV investigation. The voltage flicker assessment was performed using results from the other models.

1.3 Basic Data and Assumptions

For the circuit penetration study, the following data and assumptions were included:

- A year of 15-minute metered substation transformer data was provided by the Company, including kW, kVAR, and calculated power factor.
- The gross daytime minimum and maximum loads for each feeder was provided by the Company, which is the value recorded, not including distributed generation that may have been online at the time.
- Unity power factor was studied for the PV output for each NEM.
- Source impedance for the substation at which TSF-H158 and TSF-H159 are located, at the 46 kV and 12.47 kV bus, was provided by the Company in the ASPEN Oneliner model.
- Each 46 kV – 12.47 kV transformer was modeled in SynerGEE with the substation transformer LTC.
- There are no capacitors or voltage regulators on the H158 and H159 circuits.
- The following standards were used in the analysis:
 - IEEE Standard 1547-2008, “IEEE Standard for Interconnecting Distributed Resources with Electric Power Systems”
 - Company Engineering Standard Practices (ESPM)
- The following operational planning criteria were considered for the analysis:
 - Primary distribution line voltage should remain between 114 V – 126 V in order to maintain the ANSI standard service voltages; noted on a 120-volt base.
 - Substation transformer loading limited to 100% of base nameplate.

- Conductor/cable loading limited to 100% of thermal capacity.
- In this report, penetration of PV to load is referenced as percent daytime minimum load (% DML) and percent daytime peak load (% DPL)

This page intentionally left blank.

Section 2 STUDY RESULTS

2.1 Thermal Loading and Voltage

Using SynerGEE to analyze capacity and voltage, the following results for the existing NEM penetration levels include maximum percent conductor/cable loading, maximum and minimum primary distribution voltage, circuit level and substation transformer level kW and kVAR values, and substation transformer tap positions.

**Table 2-1
Existing System Results at Peak Daytime Loading**

Location	Peak Load (kW) ¹	kVAR	Maximum Percent Conductor/Cable Capacity ²	Maximum Voltage on a 120-volt base (V)	Minimum Voltage on a 120-volt base (V)	Substation Transformer Tap Position
TSF-H158	6,844	656	--	--	--	2(R)
TSF-H159	3,219	-136	--	--	--	(N)
H158-1	2,646	158	27%	119.2	118.2	--
H159-1	801	-120	8%	120.0	119.4	--
H159-2	2,401	-121	25%	120.0	118.7	--
H158-2	4,199	498	43%	119.2	117.2	--

Notes:

1. Includes existing PV locations.
2. Represents results for primary 12.47 kV elements in the SynerGEE model on each feeder.

**Table 2-2
Existing System Results at Minimum Daytime Loading**

Location	Min Load (kW) ¹	kVAR	Maximum Percent Conductor/Cable Capacity ²	Maximum Voltage on a 120-volt base (V)	Minimum Voltage on a 120-volt base (V)	Substation Transformer Tap Position
TSF-H158	1,119	157	--	--	--	(N)
TSF-H159	-649	-342	--	--	--	(N)
H158-1	574	10	9%	120.0	119.2	--
H159-1	21	-131	8%	120.6	120.3	--
H159-2	-670	-217	20%	121.0	119.9	--
H158-2	534	134	21%	120.0	119.2	--

Notes:

1. Includes existing PV locations.
2. Represents results for primary 12.47 kV elements in the SynerGEE model on each feeder.

Section 2

The existing level of PV was incrementally increased until hard limits were reached. The maximum penetration levels are presented below, as well as identification of the actual hard limit reached.

In incrementally increasing PV penetration on each feeder individually, Leidos found the following allowable PV growth percentages for each feeder.

**Table 2-3
Maximum % PV Growth Identified By Feeder**

Location	Maximum % PV Growth at Peak Load	Total PV (kW)	% DPL	Hard Limit Reached	Maximum % PV Growth at Min Load	Total PV (kW)	% DML	Hard Limit Reached
H158-1	>1000%	9,610	262%	None	>1000%	9,610	624%	None
H159-1	>1000%	2,850	261%	None	>1000%	2,850	931%	None
H159-2	500%	13,920	265%	1000AL UG feeder exit at 100% capacity	400%	11,136	523%	1000AL UG feeder exit at 100% capacity
H158-2	625%	17,118	242%	1000AL UG feeder exit at 100% capacity	500%	13,695	417%	1000AL UG feeder exit at 100% capacity

Note: If hard limits were not reached beyond 1000% PV growth, analysis stopped at 1000%.

Once the maximum % PV growth by feeder was identified, Leidos ran simulations on each substation transformer, growing PV penetration two feeders at a time using the same growth percentage for both feeders.

**Table 2-4
Maximum % PV Growth Identified by Substation Transformer**

Location	Maximum % PV Growth at Peak Load	Total PV (kW)	% DPL	Hard Limit Reached	Maximum % PV Growth at Min Load	Total PV (kW)	% DML	Hard Limit Reached
TSF-H158 (H158-1 & H158-2)	575%	21,275	198%	Unit 1 Transformer loaded to 10MVA	400%	14,800	307%	Unit 1 Transformer loaded to 10MVA
TSF-H159 (H159-1 & H159-2)	500%	15,345	242%	Unit 2 Transformer loaded to 10MVA	400%	12,276	504%	Unit 2 Transformer loaded to 10MVA

At peak load, the hard limit for maximum percent PV growth is the substation transformer sizes of 10 MVA each. Transformer backfeed loading reaches this limit at 575% PV growth (198% DPL) on TSF-H158 (Circuits H158-1 and H158-2) and 500% (242% DPL) on TSF-H159 (Circuits H159-1 and H159-2). Leidos modeled this load growth in SynerGEE and the results are summarized in Table 2-5 and Figures 2-1 and 2-2. The results present the maximum percent conductor/cable loading, maximum and minimum primary distribution voltage, circuit level and substation transformer level kW and kVAR values, and substation transformer tap positions for the maximum penetration levels identified. Exceptions to operational capacity limits can be seen in the figures.

Table 2-5
Maximum PV Growth Results at Peak Daytime Loading

Location	Peak Load (kW) ¹	kVAR	Maximum Percent Conductor/Cable Capacity ²	Maximum Voltage on a 120-volt base (V)	Minimum Voltage on a 120-volt base (V)	Substation Transformer Tap Position
TSF-H158	-10,123	1,840	--	--	--	(N)
TSF-H159	-9,425	731	--	--	--	(N)
H158-1	-1,805	184	71%	121.0	117.2	--
H159-1	-343	-123	39%	121.7	119.0	--
H159-2	-9,082	-66	98%	124.3	119.0	--
H158-2	-8,318	609	145%	122.9	118.1	--

Notes:

1. Includes existing PV locations grown at 575% (198% DPL) for H158-1 & H158-2 and 500% (242% DPL) for H159-1 & H159-2.
2. Represents results for primary 12.47 kV elements in the SynerGEE model on each feeder.

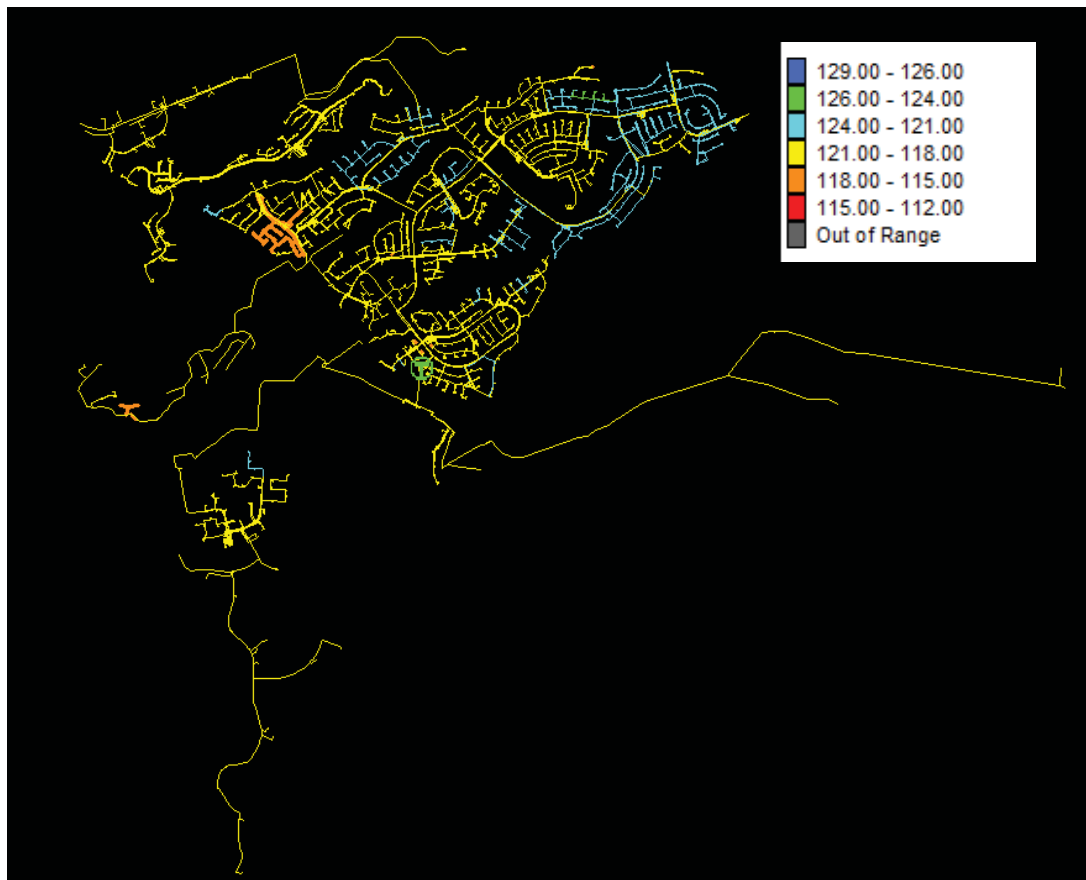

Figure 2-1. Peak Load Scenario – Maximum PV Growth Scenario – Color by Voltage

Section 2

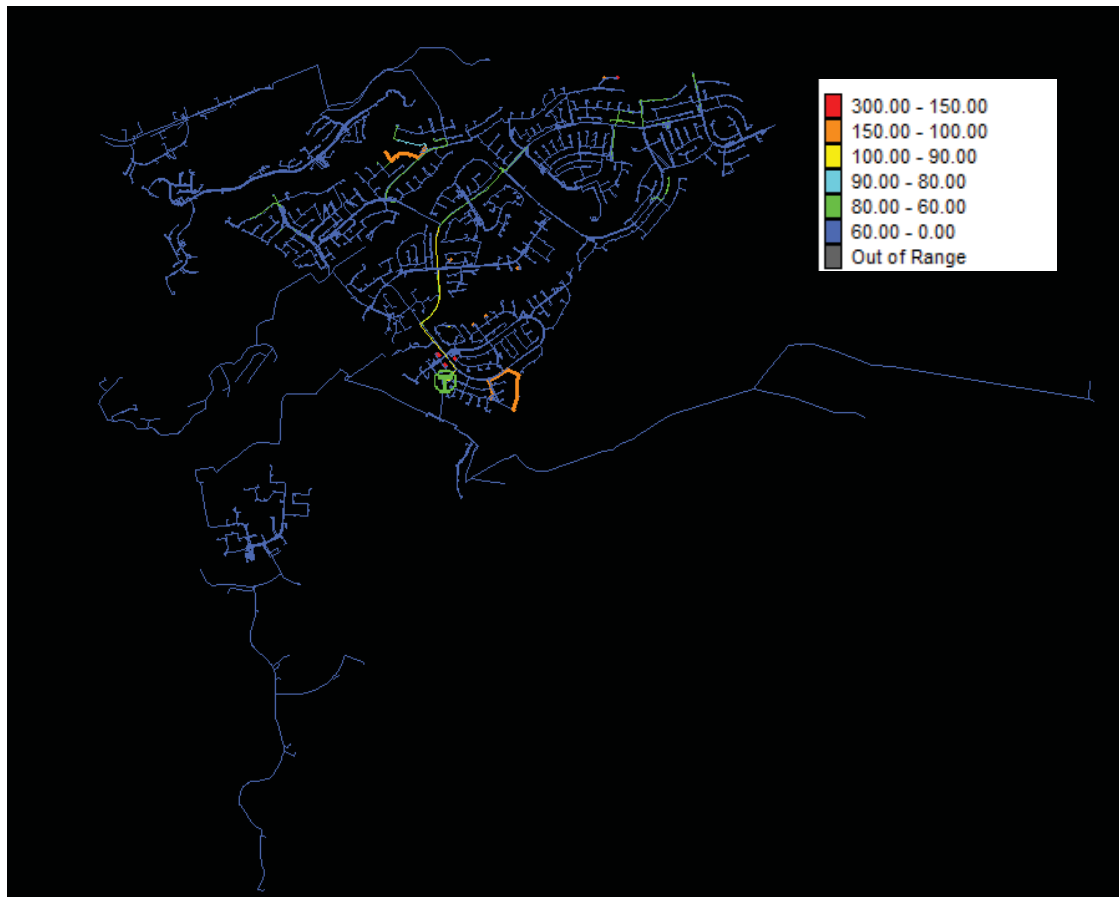

Figure 2-2. Peak Load Scenario – Maximum PV Growth Scenario – Color by Conductor Loading

At minimum load, the hard limits for maximum percent PV growth are also the substation transformer sizes of 10 MVA each; however, at minimum load, the transformer backfeed load reaches this limit at 400% PV growth on both transformers, 307% DML for TSF-H158 and 504% DML for TSF-H159. Leidos modeled this load growth in SynerGEE and summarized the results in Table 2-6 and Figures 2-3 and 2-4. Exceptions to operational capacity limits can be seen in the figures.

Table 2-6
 Maximum PV Growth Results at Minimum Daytime Loading

Location	Peak Load (kW) ¹	kVAR	Maximum Percent Conductor/Cable Capacity ²	Maximum Voltage on a 120-volt base (V)	Minimum Voltage on a 120-volt base (V)	Substation Transformer Tap Position
TSF-H158	-9,671	1,196	--	--	--	(N)
TSF-H159	-10,060	761	--	--	--	(N)
H158-1	-2,252	29	53%	121.4	118.6	--
H159-1	-839	-129	34%	121.5	120.7	--
H159-2	-9,291	-160	100%	124.1	119.8	--
H158-2	-7,419	227	104%	122.8	119.3	--

Notes:

1. Includes existing PV locations grown at 400% for H158-1, H159-2, H159-1, H159-2; 307% DML for TSF-H158 and 504% DML for TSF-H159.
2. Represents results for primary 12.47 kV elements in the SynerGEE model on each feeder.

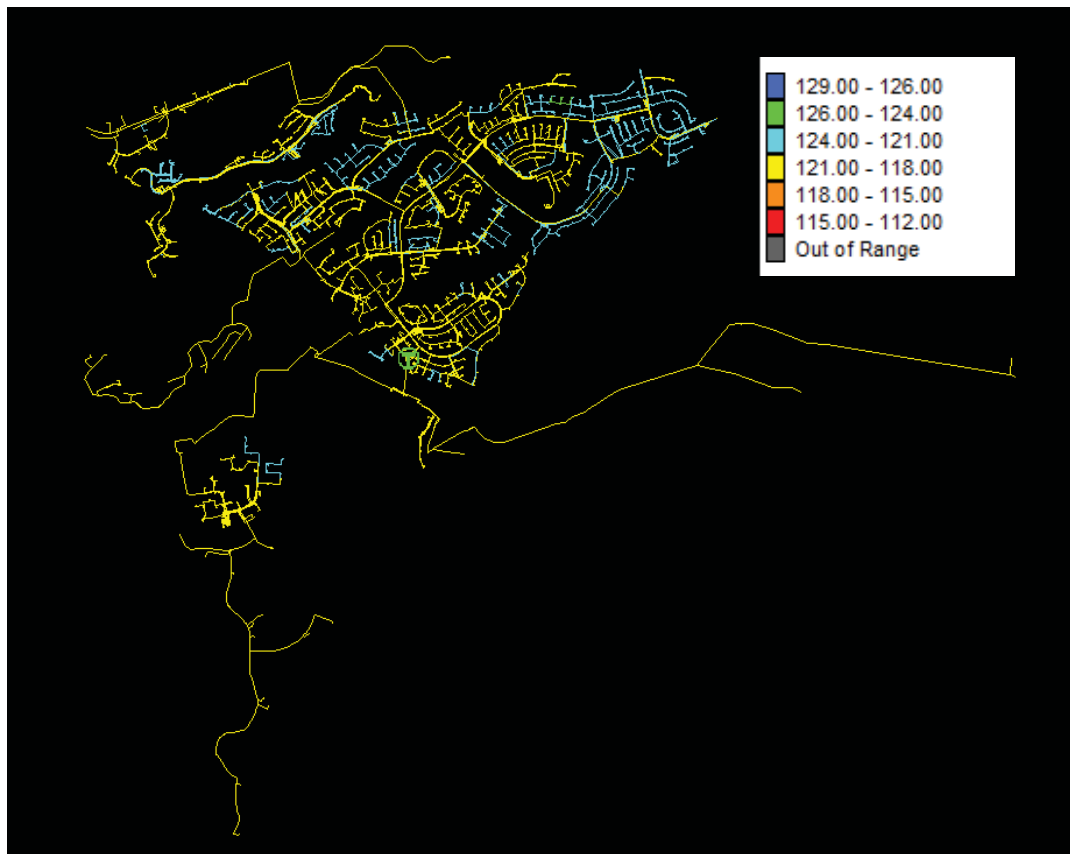

Figure 2-3. Min Load Scenario – Maximum PV Growth Scenario – Color by Voltage

Section 2

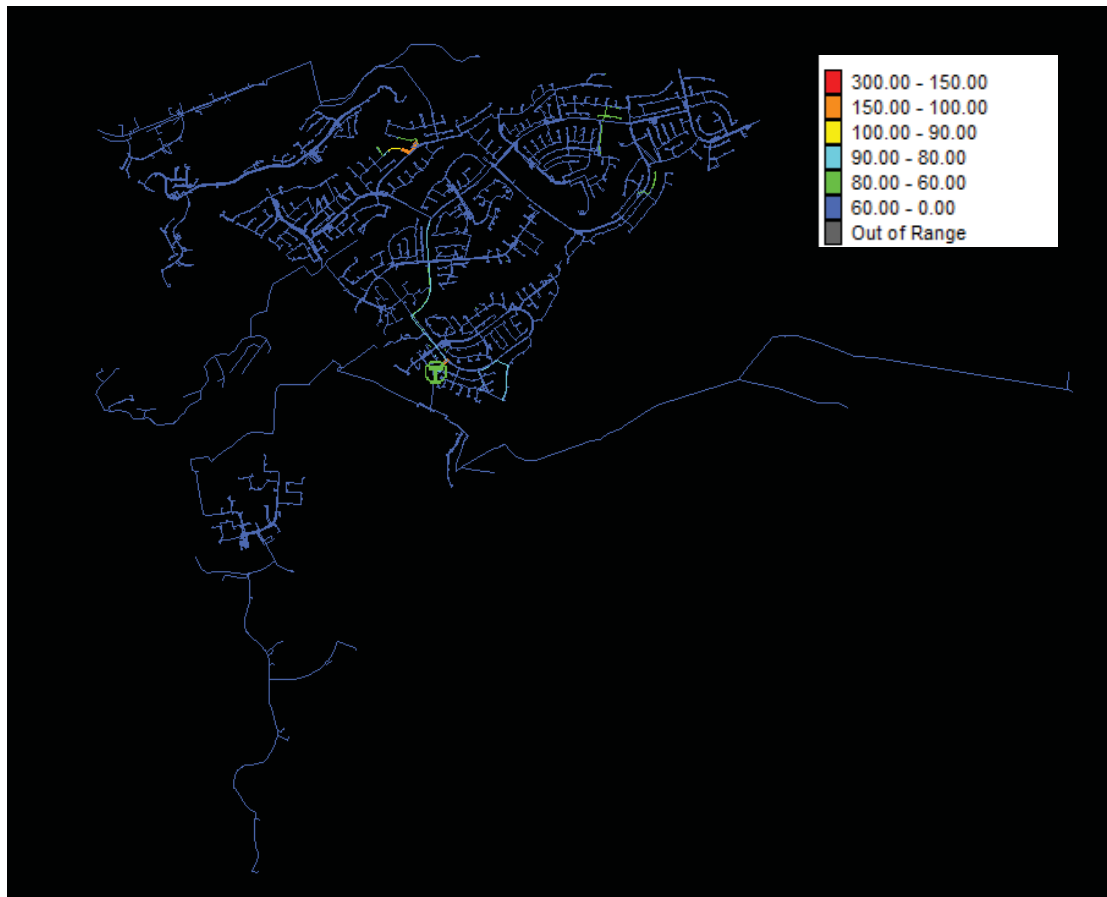

Figure 2-4. Min Load Scenario – Maximum PV Growth Scenario – Color by Conductor

In comparing the by-feeder results to the by-substation transformer results, the minimum load analysis by-substation transformer is the limiting PV growth case. The H158 and H159 circuits can grow in PV penetration by an average of 400% before reaching the hard limit of substation transformer capacity.

For both minimum and maximum load scenarios, the limiting factor appears to be the substation transformer capacity. At its maximum nameplate capacity, with PV penetration growth, the feeder backbone conductors for both H159-2 and H158-2 circuits are near capacity. In contingency conditions, where the Company relies on distribution feeder ties, increased PV penetration could impact available tie capacity. For tie feeders with more load than PV, switching capacity should be available to feeders with heavy PV penetration because the PV will absorb the load, which typically relieves capacity. For tie feeders with more PV than load, switching capacity will be limited to tie to a feeder with a similar heavy PV penetration. On a by-feeder basis, reverse flow should be monitored and considered when tying circuits together in a contingency. If there are not multiple feeder tie options for some areas of the Company system and increased levels of PV create difficulties in contingency switching, the Company could consider requiring PV to be offline under contingency situations. If requiring the PV offline under contingency situations is not plausible, the Company should limit reverse flow to 50% in order to maintain normal traditional planning and operational flexibility.

2.1.1 Secondary Voltage Level Analysis

While the results identified minor high voltage on the primary distribution system, the Company is expected to have more high-voltage areas on the secondary system. For the 82 service transformers and PV systems on the secondary service side modeled, Leidos found that when the generation increased on the secondary lines modeled, the voltage increased to much higher levels on the secondary versus the primary lines providing service.

In Figure 2-5 below, the customer load is 32 kW, the transformer is 50 kVA, and the PV (modeled as a generator) is 2 kW. The figure illustrates that on a 120-volt base the secondary line section is at a lower voltage level than the primary.

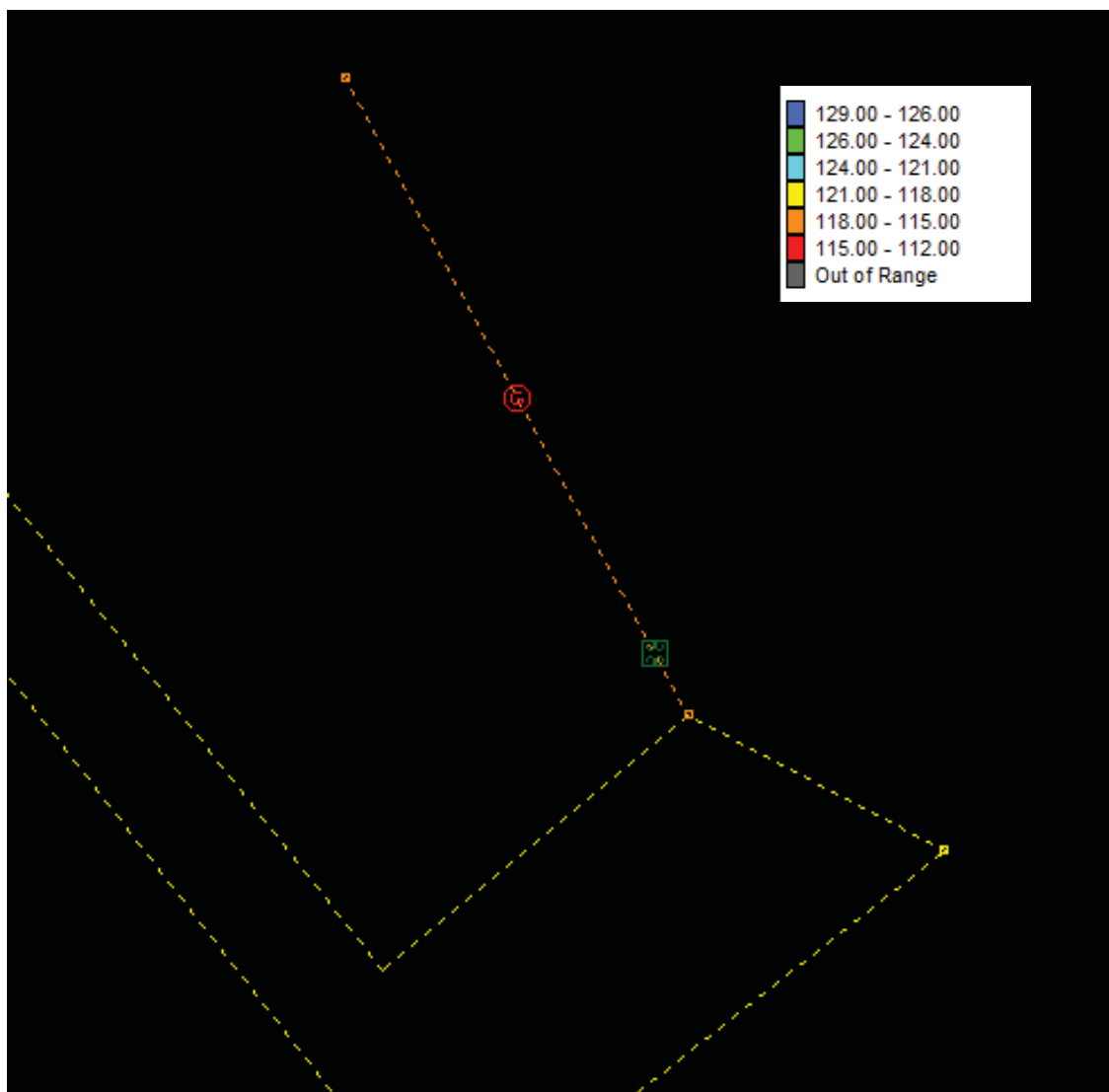

Figure 2-5. Example of Secondary Line Voltage Calculation under Existing Conditions

Section 2

In Figure 2-6, if the PV is increased to 32 kW, which is equal to customer load, the secondary voltage increases from a range of 115-118 volts to a range of 121- 124 volts. That level keeps rising as PV is increased, but it takes much more of a PV increase to affect the primary voltage than the secondary voltage level, based on the simulations. Voltage issues are likely to arise on secondary lines before primary lines.

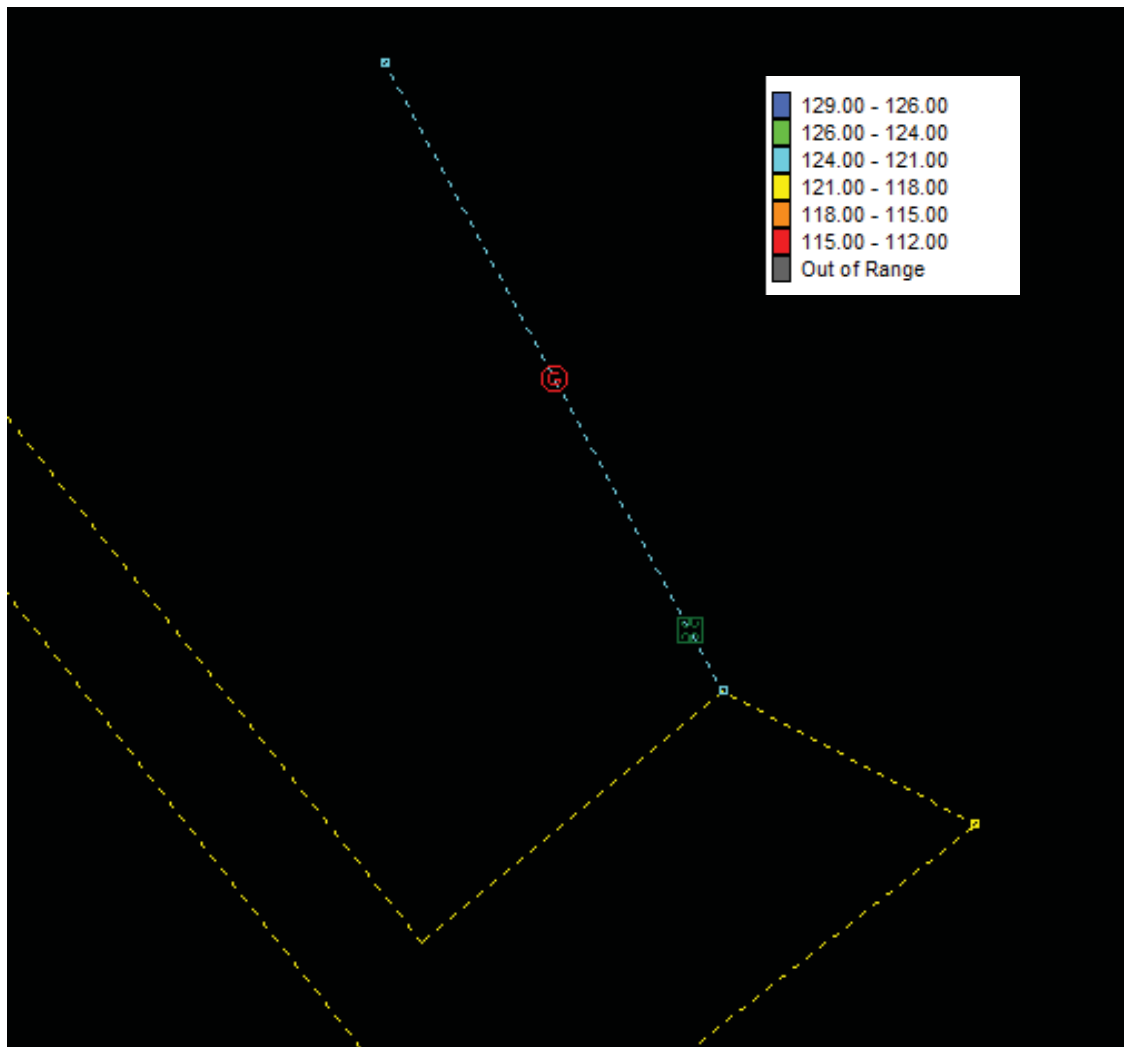

Figure 2-6. Second Example of Secondary Line Voltage Calculation at Increased PV Penetration

In addition, Leidos identified 50 service transformers over capacity with the current customer peak information and existing connected NEMS, as provided by the Company. Because minimum daytime loading is more of a concern for loading on the transformers when PV is online, Leidos evaluated the peak customer load measured decreased by 40% on each transformer, which is the average ratio of the gross minimum to maximum loading the Company provided for the H158 and H159 circuits. At the estimated minimum load, none of the service transformers are currently overloaded.

However, with a 400% increase in PV modeled, 280 transformers will potentially be over capacity during minimum loading. Along with additional secondary upgrades to accommodate more NEMs, Leidos anticipates that a large number of service transformers will require upgrades.

2.1.2 Impact on Load Tap Changers

Both Transformers TSF-H158 and TSF-H159 are equipped with load tap changers (LTCs). In their current state, they are designed to lock out in reverse flow conditions and not continue to move tap positions as load in the reverse direction moves through the transformer. The set point voltage for each is 120 V, and the bandwidth is +/-1 V (or 2 V total). The time delay for adjustments is 30 seconds. The analysis was simulated with these setting, and the results show that when reverse flow moves through the substation transformers, the LTCs lock at neutral. The minimum voltage on the feeders is slightly impacted. In some areas, the voltage increases, while in others, where there is not a large penetration of PV, the voltage decreases slightly.

To gather perspective on the impact of tap movement, Leidos modeled various levels of PV penetration to investigate tap movement on the TSF-H158 and TSF-H159 LTCs. Other than evaluating the peak and minimum system load conditions, Leidos did not evaluate fluctuations in consumer load that would also affect tap position.

**Table 2-7
Impact on LTC Movement**

Scenario	Total NEMs (kW)	TSF-H158 Distribution Bus Voltage (V)	TSF-H159 Distribution Bus Voltage (V)	TSF-H158 LTC Tap	TSF-H159 LTC Tap
Peak Load - Existing	6,769	119.9	120.0	2R	N
Peak Load -Existing – No PV	0	119.9	119.6	3R	N
Peak Load - 200% PV Growth	13,558	119.7	120.3	1R	N
Peak Load - 300% PV Growth	20,307	119.2	120.4	N	N
Peak Load - 400% PV Growth	27,076	119.4	120.4	N	N
Min Load - Existing	6,769	119.7	120.5	N	N
Min Load - Existing – No PV	0	119.4	120.2	N	N
Min Load - 200% PV Growth	13,558	119.9	120.6	N	N
Min Load - 300% PV Growth	20,307	120.0	120.6	N	N
Min Load - 400% PV Growth	27,076	119.8	120.4	N	N

In the peak load scenario, as PV penetration increases, the tap moves towards neutral position for TSF-H158. Also in the peak load scenario, the T1 LTC is at tap 2R for the existing system with current level of PV penetration. When the PV is decreased to zero, the tap increases to 3R. This shows the potential for tap movement as PV decreases due to cloud cover, which is 1 tap. Due to infinite possibilities of cloud cover scenarios, it is difficult to determine how much tap movement will occur between the neutral and 3-Right position identified for T1. Leidos recommends recording and monitoring LTC and line regulator tap movement to get a more

Section 2

accurate depiction of the impacts of PV on the system at the current level of interconnection and as it increases. If the Company has a planning criteria for limiting tap changes annually, for example, recording tap movement can be used to determine when the planning criteria is violated and be an indicator of PV saturation on the substation transformer and or feeder.

From the analysis, it appears that the current LTC control setting is acceptable for the TSF-H158 and TSF-H159 transformers. From the substation to the end of the feeder, the H158 and H159 circuits have a narrow bandwidth of voltage. So, voltage tends to stay within the bandwidth of the LTC control, and have little movement. For other areas of the Company distribution system, if feeders have a larger bandwidth of voltage measurements, the Company may consider adding line voltage regulators to reduce feeder voltage bandwidth or consider alternative LTC settings, where it continues to regulate in the forward position, even in reverse flow conditions, which is referred to as co-generation mode. Leidos recommends co-generation mode for voltage regulators on the distribution feeders.

2.2 Short Circuit and Protection Analysis

With the maximum penetration levels of PV identified for each feeder as shown in the previous section, a short circuit analysis was completed using ASPEN and SynerGEE to determine protection impacts.

The existing substation source impedance and fault calculations are presented below in Table 2-8.

Table 2-8
Source Impedance and Existing Fault Calculations

Source	Nominal Voltage (kV)	3LG (amps)	1LG (amps)	Positive Sequence (ohms)		Zero Sequence (ohms)	
				R	X	R	X
TSF-H158	46	3731	2017	1.71754	7.07648	4.27637	25.5137
TSF-H159	46	3111	2476	1.08855	8.64187	3.17543	15.1164

Note: Impedance provided in ASPEN Oneliner model.

The Company provided information indicating the micro-inverter is widely used on the Company distribution system for NEM installations and represents typical inverter specifications for fault contribution on the system. The fault contribution, based on inverter manufacturer data, is 1.05 of the continuous current rating, which equates 0.95 amps at 240 volts.

Table 2-9 presents the estimated total fault contribution of the NEMS at a 400% increase in PV penetration, assuming the most limiting case determined from load flows as discussed in Section 2.1. The short circuit calculations at maximum PV penetration levels do not indicate an issue in terms of exceeding protective device interrupting ratings. The Company limit of 5,000 amps, by pole or by feeder, essentially, is not expected to be exceeded.

Table 2-9
Calculated Fault Current at Maximum Penetration Levels

Location	All PV Off		PV On		Max Fault Current Contribution from 400% PV growth (amps)
	LLL (amps)	LG (amps)	LLL (amps)	LG (amps)	
TSF-H158	3,445	3,779	4,006	4,326	551
TSF-H158	3,281	3,637	3,919	4,279	642

Note: Fault current measured at substation low-side bus at 12.47 kV.

In addition, the feeder relay pick-ups are set for 600 amps. Relay pick-ups are not a limiting factor from this analysis based on existing customer load, assuming the inverters will start up later than the load is energized. IEEE 1547 states that there should be a 5-minute delay before inverters energize after a system outage scenario.

Tap fuses should be monitored and replaced as PV penetration grows on the distribution. While fault current will increase at fuse locations as PV penetration increases, it appears that the maximum size fuse, 100A, on the H158 and H159 feeders should continue to coordinate properly with the circuit relays. In other areas of the distribution system, if a fuse saving scheme is in place, coordination of that scheme may be impacted and should be evaluated on an individual feeder basis.

Sympathetic or nuisance protective device tripping was also considered. The relays on the H158 and H159 circuits are CO overcurrent relays, and they all have the same phase and ground settings without an instantaneous. Leidos ran several simulations to determine if a fault on an adjacent feeder could cause the un-faulted feeder to also trip based on current in the reverse direction. The fault current calculations include the PV contribution with 400% PV growth on the feeders.

Figure 2-7 illustrates the phase and ground relay TCC plots for H159-1 and H159-2 circuits. A fault was placed on the feeder exit of H159-1, and the fault current was measured there as well as at the circuit breaker for H159-2, which is the adjacent circuit in this instance. H159-2 sees 530 amps of three phase-to-ground current in the reverse direction, which is below the phase pick-up. H159-1 breaker sees a 4,178 amp line-to-ground fault and trips around 0.3 seconds. From the TCC, circuit 3 sees 363 amps for a line-to-ground fault and should not trip. Generally, 12 cycles or 0.2 seconds of separation for electromechanical relays is sufficient to avoid mis-coordination or mis-operation between relays. In this occurrence, nuisance tripping on H159-2 for a fault on H159-1 should not be an issue.

Section 2

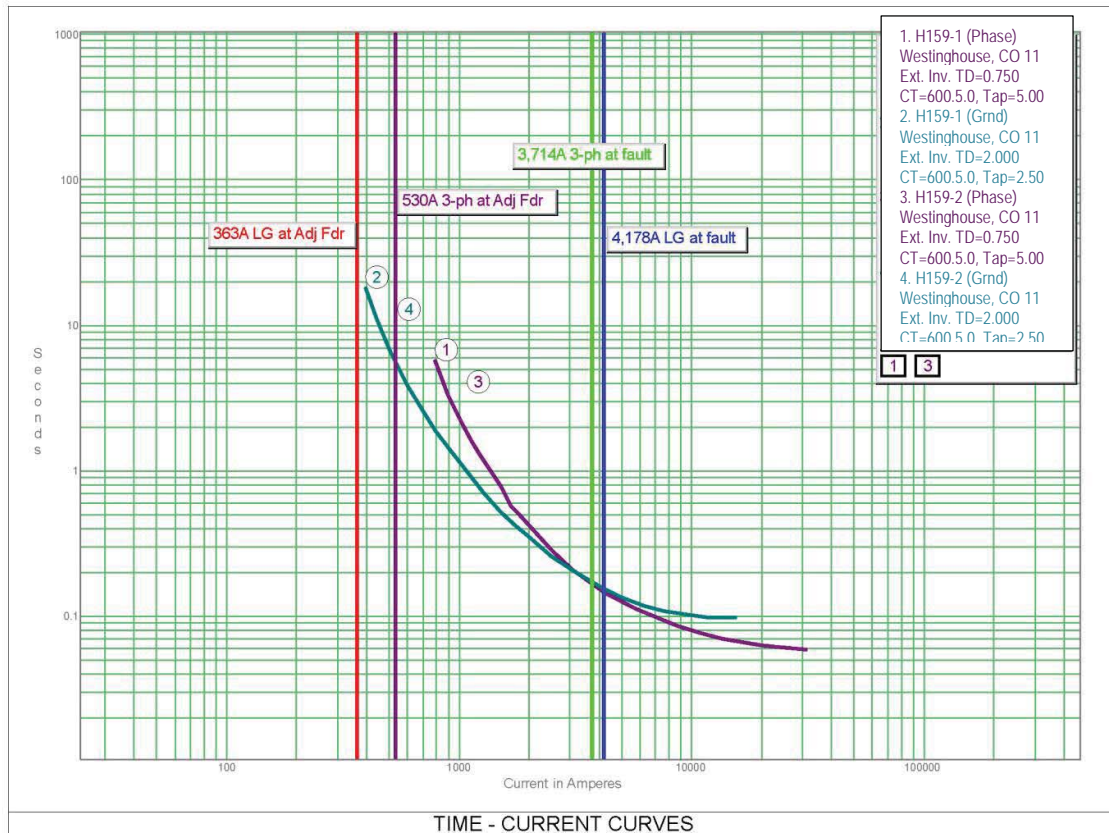

Figure 2-7. Nuisance Tripping-Fault on H159-1 (3-ph); Impact on H159-2

In addition to the scenario above, a fault was placed further out on H159-1 on a single-phase line. The TCC in Figure 2-8 shows that the adjacent H159-2 breaker should not see the fault. Nuisance tripping or sympathetic tripping on adjacent feeder relays, even at high levels of PV penetration, is not expected to be an issue.

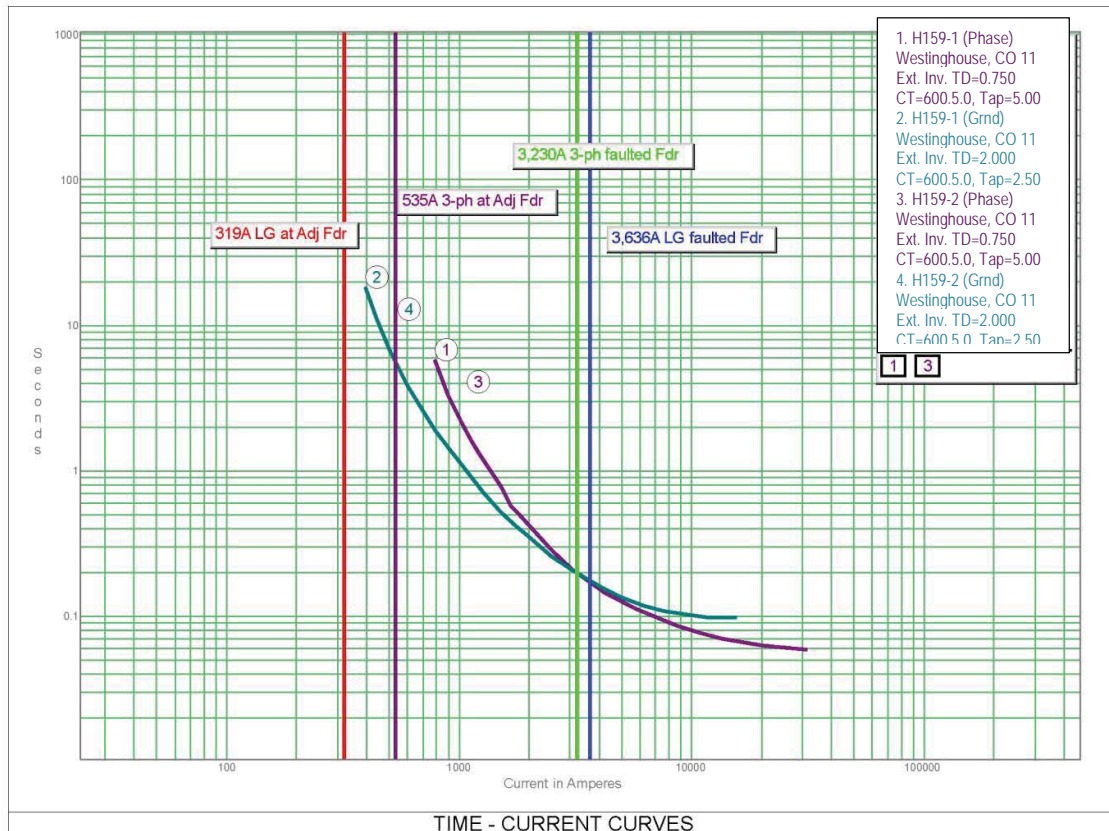

Figure 2-8. Nuisance Tripping-Fault on H159-1 (1-ph); Impact on H159-2

In evaluating the other circuits, Leidos identified similar results. The four circuits studied do not have instantaneous settings or mid-line protection devices. Based on the results of this study, the Company should avoid implementing low-set instantaneous overcurrent elements on circuits where there is reverse flow potential. Also, mid-line protection devices would likely experience nuisance tripping well before the circuit breaker. The Company should evaluate the possibility of this issue for circuits on the distribution system with mid-line devices and consider removing the devices or installing directional operation capability.

2.3 Voltage Flicker

Leidos performed a high-level voltage flicker assessment to determine if an increased level of intermittent DG, such as rooftop solar, could potentially cause irritating voltage fluctuations to the existing customers on the Company distribution system.

Leidos calculated voltage flicker using the steady-state power flow model in SynerGEE to determine the change in voltage when the total amount of PV decreases to no output from full output at peak load day conditions, prior to switchable and tap changing devices on the system adjusting. The percent voltage change was calculated for each modeled element in the SynerGEE model. This assumes the NEMS will respond coincidentally with each other on the four H158 and H159 circuits with cloud cover.

Section 2

For the existing level of NEMS on the four circuits, this approach resulted in a maximum voltage flicker of 1.7% and an average voltage flicker, over the four feeders, of 0.73%. Flicker is less of an issue near the substation or in areas with large conductors to the substation with low impedance.

For the maximum penetration level of 400%, assuming the most limiting case determined from load flows, a maximum voltage flicker of 4.9% and an average voltage flicker of 1.9% was calculated. The increased levels of PV increased potential voltage flicker by 290%.

A voltage flicker of nearly 2.5%, one time per hour, could be noticeable, according to the voltage flicker curve in the IEEE 519 Standard. PV ramps up and down rapidly with cloud movement. With three or more voltage dips of 4.9% per hour, the IEEE 519 standard flicker chart indicates the voltage dips would irritate the surrounding customers. For reference, see the IEEE 519 flicker chart in Figure 2-9.

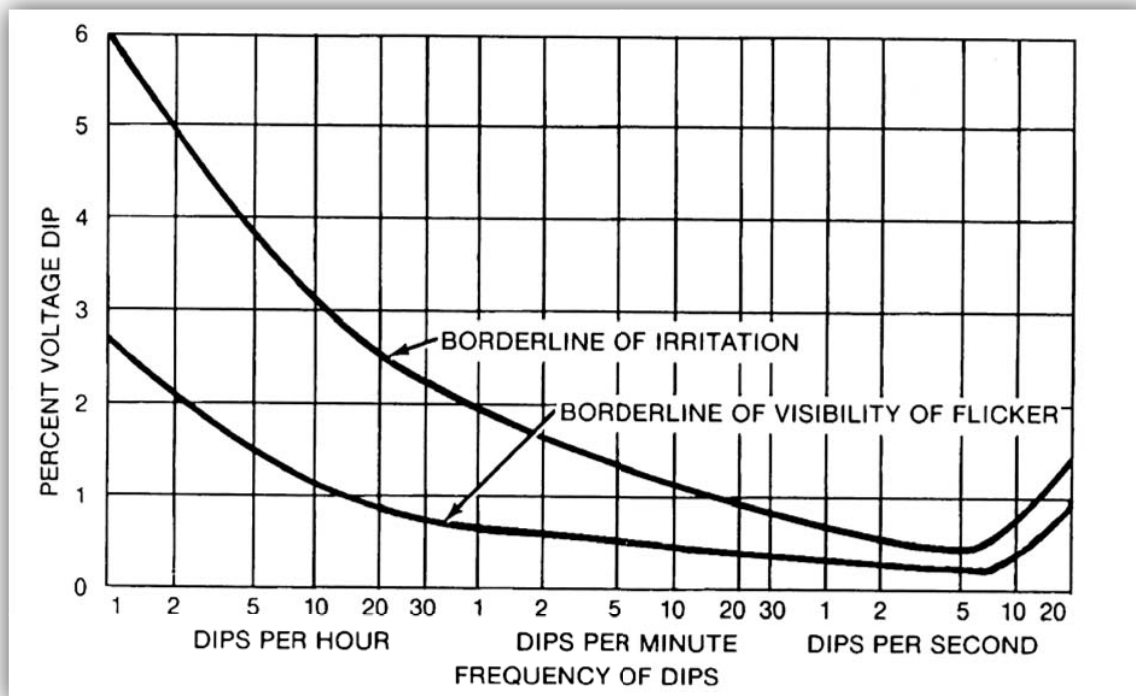

Figure 2-9. IEEE 519 Voltage Flicker Chart

However, the analysis completed in this study is very conservative in assuming all of the panels are facing the same direction and each of the connected PV inverters will swing, simultaneously and frequently, from full output to no output. Further, voltage flicker for PV is not similar to a step-function for a large industrial or motor application as assumed in the IEEE 519 flicker chart. It may not drop out completely and tends to ramp back up rather than a step-function. In comparing the existing voltage flicker calculations to potential levels of PV, growing as much as 400%, the Company can see the potential in experiencing much higher voltage flicker levels.

IEC 61000-3-7 superseded the IEEE 519 and IEEE 1453 standards to allow more in-depth discussion of the voltage flicker issue and to include the definition of a flickermeter. IEEE 1453 states that for events that occur once per hour or more, the use of a flickermeter and the subsequent Pst and Plt terms is better suited to characterize the impact than the previous standards. It also states that the previous flicker standards are still useful for infrequent events (less frequent than once per hour).

The results from the high-level flicker assessment indicate that the Company should consider adding monitoring devices on the distribution system where there are high levels of PV penetration to capture short-term and long-term flicker, Pst and Plt, respectively. To form a basis for flicker on the Company system, Leidos recommends starting out monitoring at the feeder level when PV penetration equals feeder load. If there are existing cases of this on the Company system, the Company should measure those to get a base flicker measurement for that level of PV on different types of distribution circuits such as long, short, small wires, all overhead versus underground, etc. As PV penetration grows on the system, the Company will begin to have a recorded baseline of voltage flicker across the system for 100% PV penetration. Based on the IEC standard, Pst should be limited to 0.9 and Plt should be limited to 0.7 for the medium distribution system. Depending on where the baseline measurements fall in comparison the limits, the Company can get an idea of how much room is left on the feeder for additional PV.

As the monitoring devices show Pst and Plt values getting closer to the limits, the Company can either make system upgrades such as conductor or cable upgrades to lessen the impact of voltage flicker, require inverters to operate off unity to reduce the voltage differential when they drop out, install battery storage systems, or restrict additional PV in those areas.

2.4 Load Rejection Transient Overvoltage Evaluation

Leidos built a single-phase inverter model and H158 and H159 feeder characteristics in PSCAD to review possible Transient Overvoltage (TOV) issues from load rejection and potential islanding scenarios. The model included TSF-H158 and TSF-H159 source impedance and main backbone cable parameters along H158-2. Single-phase taps were added and the single-phase inverters, representing the NEMs, were added downstream of single-phase service transformers. Single-phase residential customer loads were added at the inverter locations and three-phase customer load was added along the main primary backbone of the circuit. The following figure illustrates the configuration of the model built in PSCAD. The point labeled as “VinVS”, next to the feeder breaker, is the voltage monitoring location for the scenarios evaluated.

Section 2

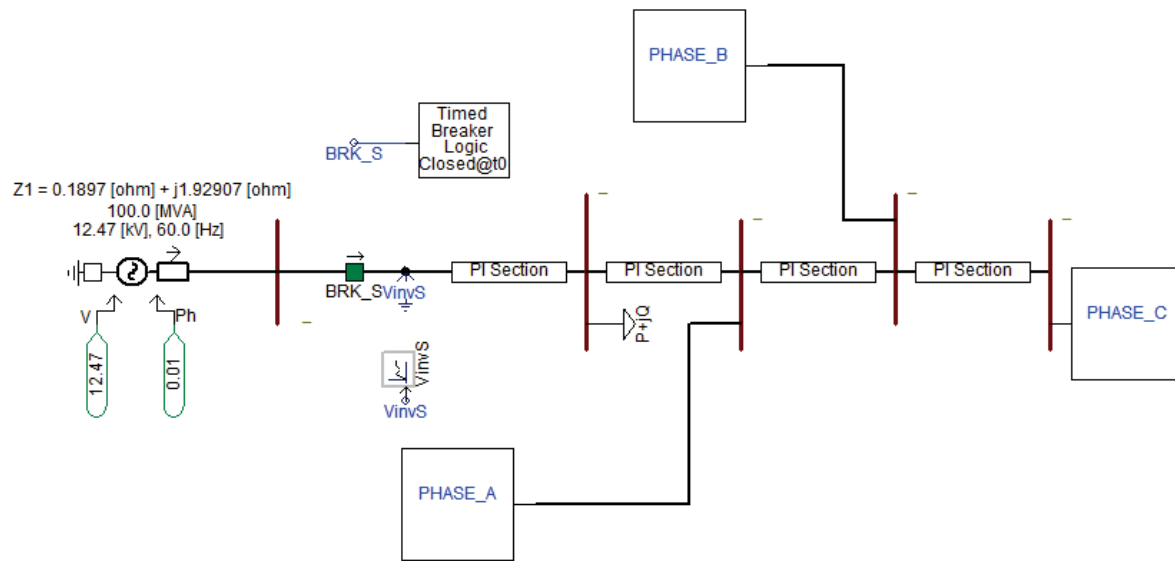

Figure 2-10. PSCAD Model Diagram – Three-phase

The single-phase inverters, representing the NEMs, were modeled with voltage response requirements from IEEE 1547, where the inverter must disconnect in 0.16 seconds or 10 cycles if measured voltage at the interconnection is greater than 120%. Additionally, the inverter has an instantaneous response built in that shuts off the inverter if voltage greater than 155% is measured. Frequency response requirements from IEEE 1547 were also modeled, where the inverters must disconnect in 0.16 seconds or 10 cycles if measured frequency at the interconnection is greater than 60.5 Hertz. Leidos incorporated all three inverter responses into the study.

The following figure represents the internal schematic of each box from Figure 2-10 labeled as either PHASE_A, PHASE_B, or PHASE_C. The boxes include the single-phase taps, service transformers, single-phase customer load, and single-phase inverters.

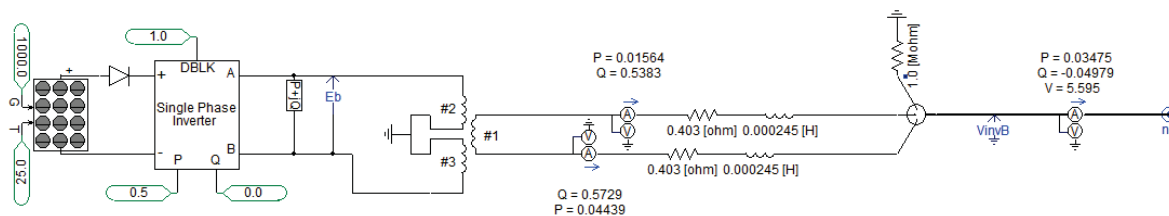

Figure 2-11. PSCAD Model Diagram – Single-phase details

The inverters were modeled as 0.5 MW inverters, which represents a larger quantity of NEMS in an area. The other customer load, on the secondary and primary areas of the circuit, varied in each scenarios evaluated. The customer load was modeled assuming a 98% power factor, which is in line with load data provided by the Company.

The following load rejection scenarios were evaluated.

- Scenario 1 – 100% DML
- Scenario 2 – 120% DML
- Scenario 3 – 130% DML
- Scenario 4 – 140% DML
- Scenario 5 – 150% DML
- Scenario 6 – 200% DML
- Scenario 7 – 300% DML

2.4.1 TOV Results

For each scenario, Leidos simulated when the feeder breaker opens at 1 second into the simulation. The inverters include frequency and voltage trip settings based on IEEE 1547 requirements and the fast trip voltage setting of 155% based on the inverter. The results were compared to the ITI (CBEMA) Curve, which limits various levels of high voltage over time to prevent 120-volt customer equipment from damage. See Figure 2-12.

The CBEMA Curve shows that voltages greater than 120% cannot last longer than 3 milliseconds. Voltages less than 120% can continue up to 0.5 seconds. Voltages less than 110% can continue beyond that up to steady-state conditions.

Section 2

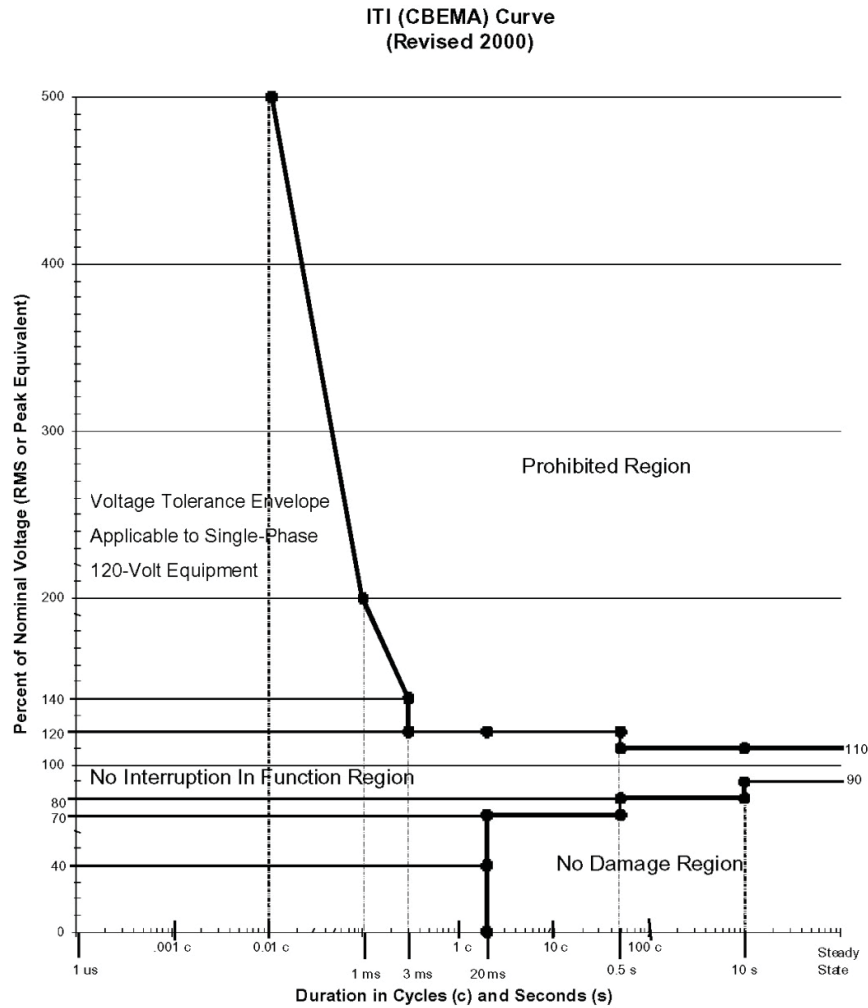

Figure 2-12. ITI (CBEMA) Curve

The following table summarizes the results of the scenarios evaluated. The results show the duration of the maximum voltage recorded, the magnitude of the largest voltage spike, and if the results meet ITIC. Up until Scenario 7, the inverter side voltage did not reach the 155% voltage instantaneous trigger.

Table 2-10
TOV Results by Scenario

Scenario	Description	Duration (milliseconds)	TOV Magnitude	Meets ITIC
Scenario 1	100% DML	160	96%	YES
Scenario 2	120% DML	160	100%	YES
Scenario 3	130% DML	160	106%	YES
Scenario 4	140% DML	160	120%	YES
Scenario 5	150% DML	160	139%	NO
Scenario 6	200% DML	160	168%	NO
Scenario 7	300% DML	1.9	244%	YES

Note: Voltage spikes measured on primary distribution system adjacent to the circuit breaker.

The results show that a PV to minimum load penetration of 140% is achievable without causing concern for overvoltage. In Scenario 6, while the primary side voltage was greater than 155%, the secondary side of the inverters did not reach 155% (Figure 2-24). Therefore, the voltage fast trip did not respond in this scenario. Scenario 7 results in TOV for 244% for less than 0.1 milliseconds, but the duration of voltage, greater than 120%, is 1.9 milliseconds because the fast trip at 155% is triggered. The analysis shows that even if the connected inverters do not have the fast/instantaneous trip, overvoltages in relation to the CBEMA curve are not a concern at 140% penetration. The frequency trip setting is the trigger for the scenarios up until Scenario 7.

The following figures, with results, will help further explain the findings. The X-axis is seconds and the Y-axis is actual voltage in kV for the voltage charts and W (radians/second) for the frequency charts. The charts include voltage measured on the three-phase primary distribution system near the feeder breaker and voltage measured on the secondary system at the inverter interconnection.

Section 2

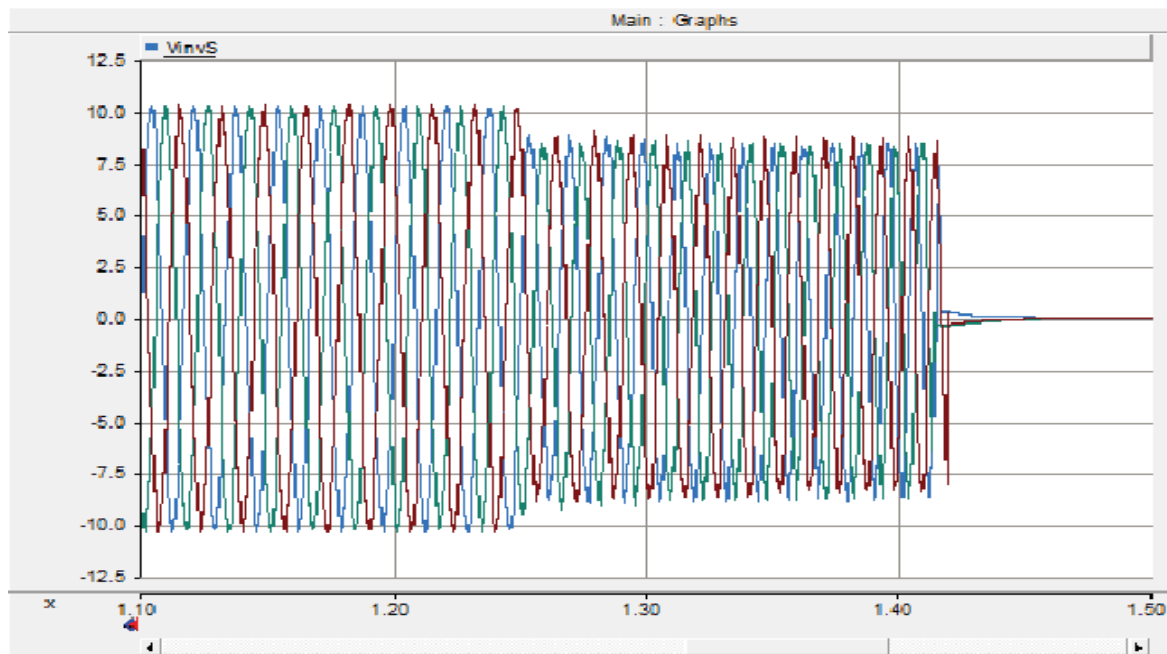

Figure 2-13. Scenario 1 - Primary Voltage

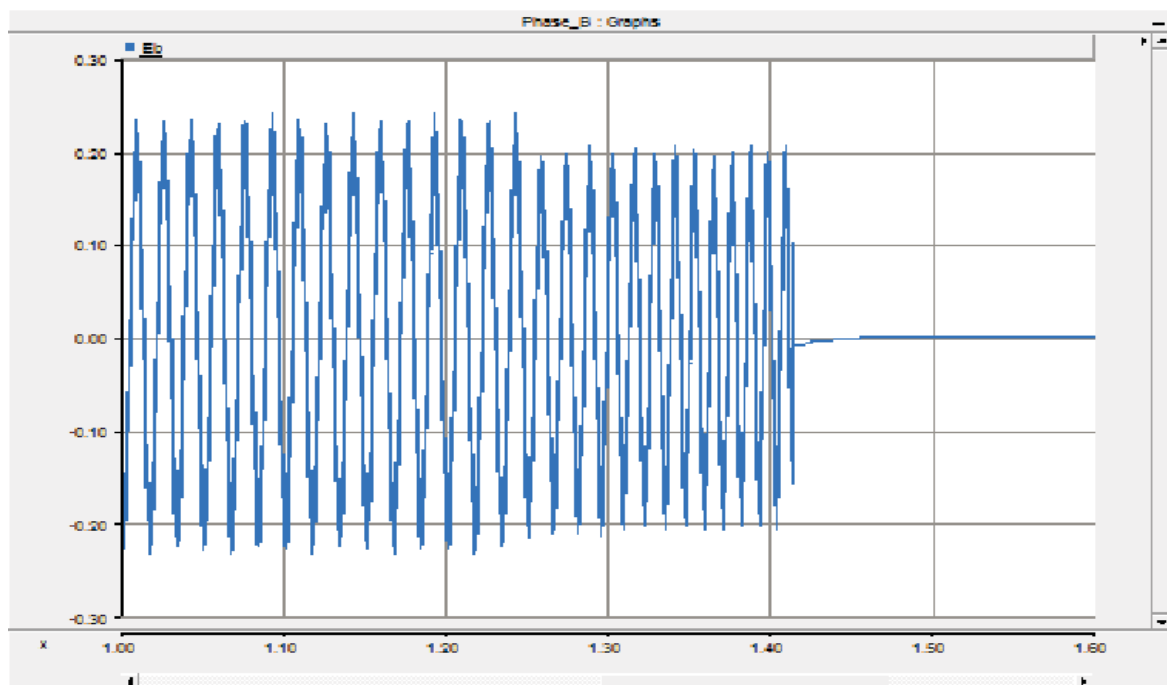

Figure 2-14. Scenario 1 - Secondary Voltage

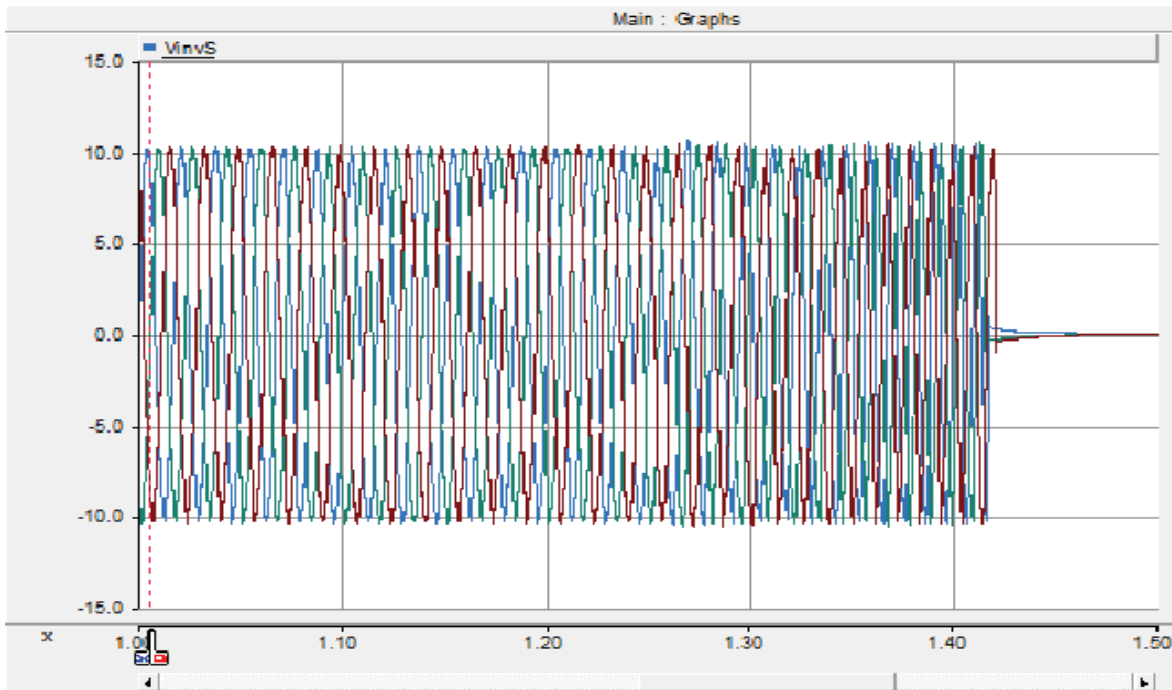

Figure 2-15. Scenario 2 - Primary Voltage

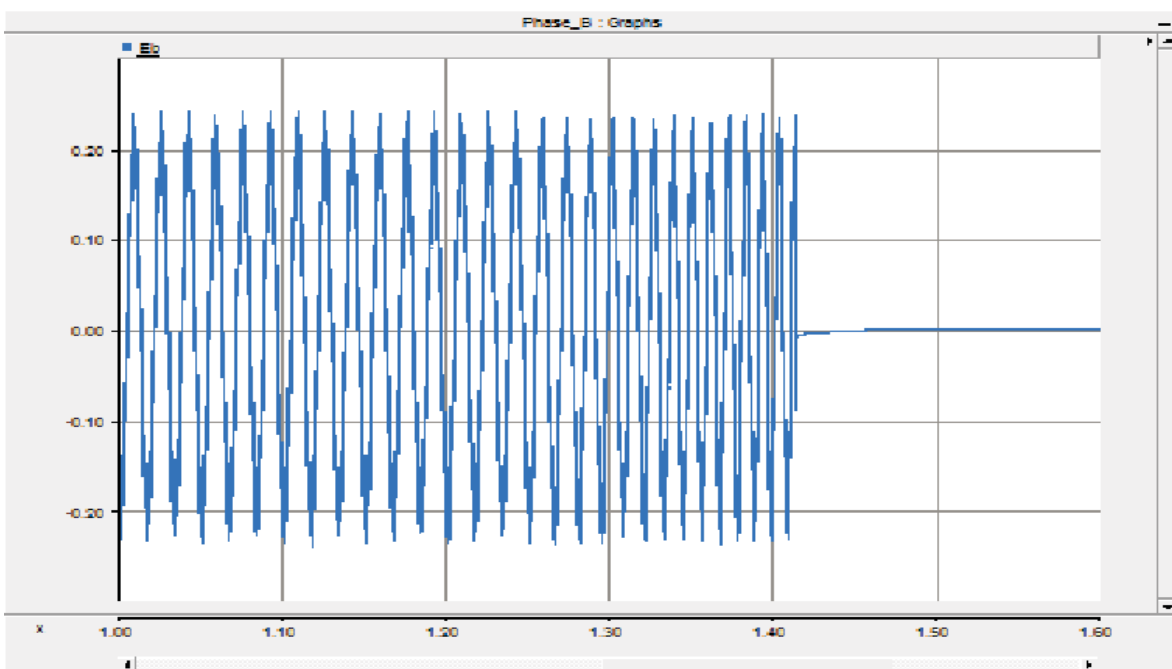

Figure 2-16. Scenario 2 - Secondary Voltage

Section 2

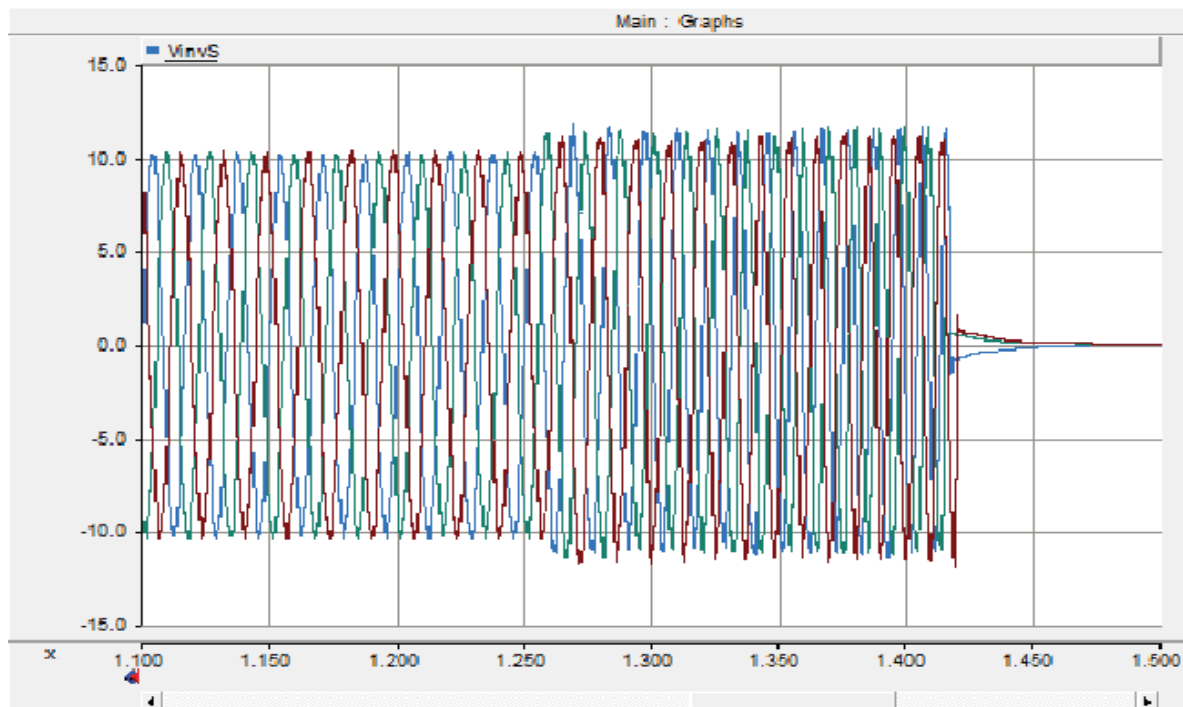

Figure 2-17. Scenario 3 – Primary Voltage

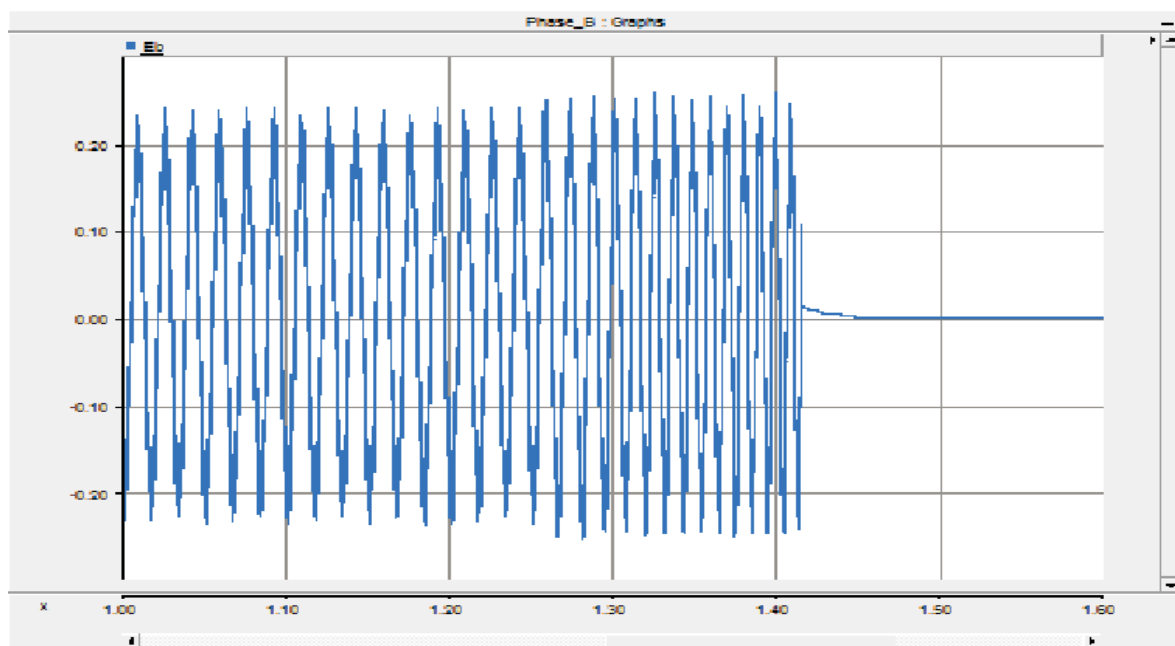

Figure 2-18. Scenario 3 – Secondary Voltage

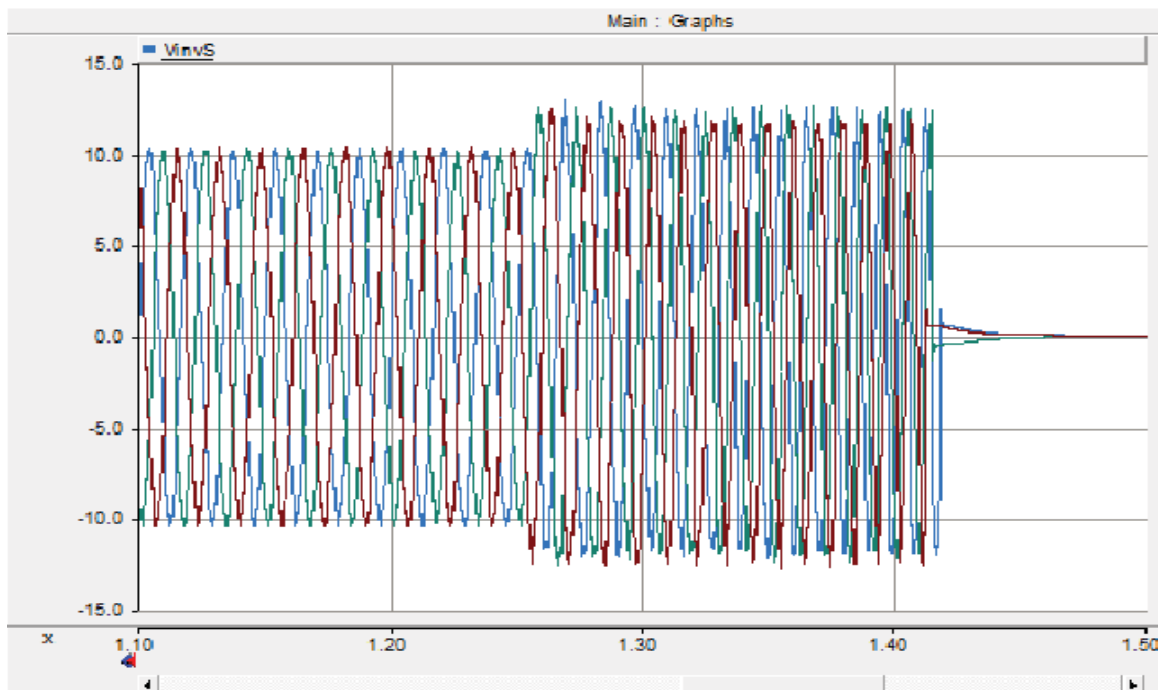

Figure 2-19. Scenario 4 - Primary Voltage

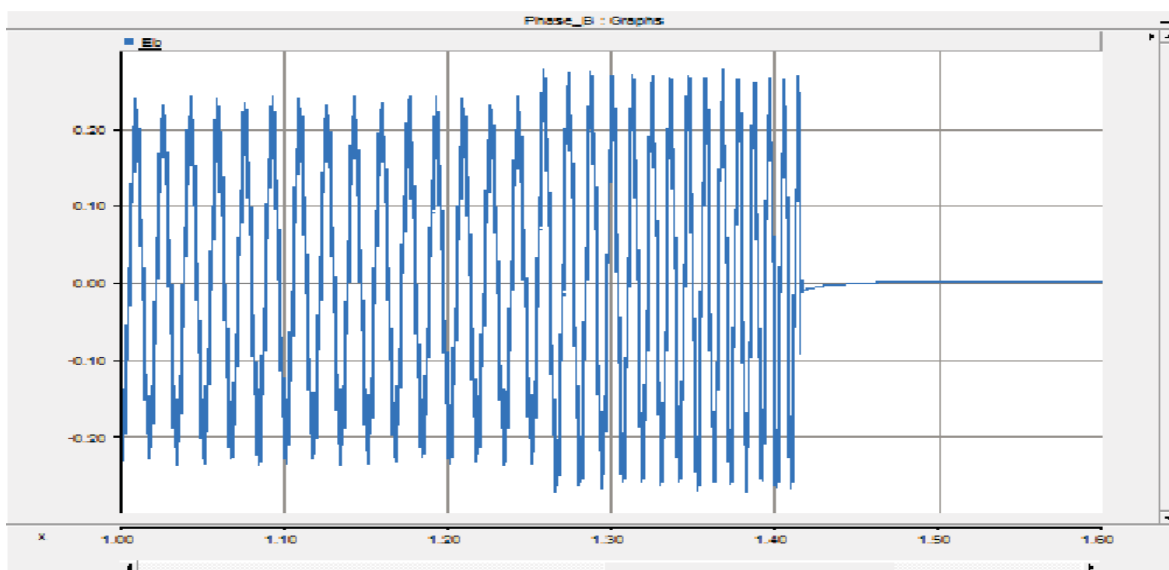

Figure 2-20. Scenario 4 - Secondary Voltage

Section 2

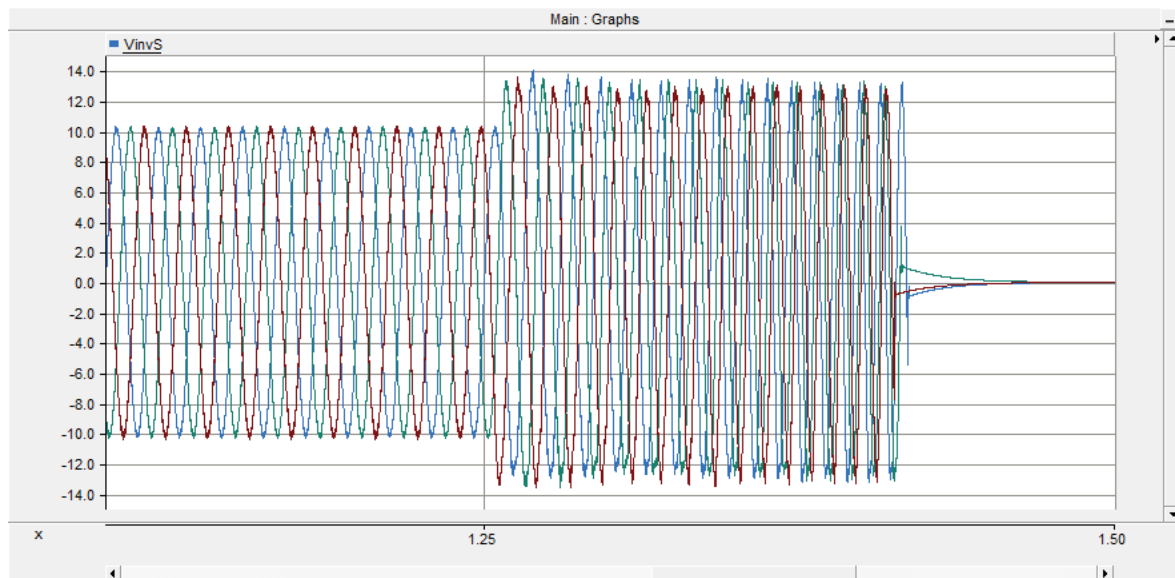

Figure 2-21. Scenario 5 – Primary Voltage

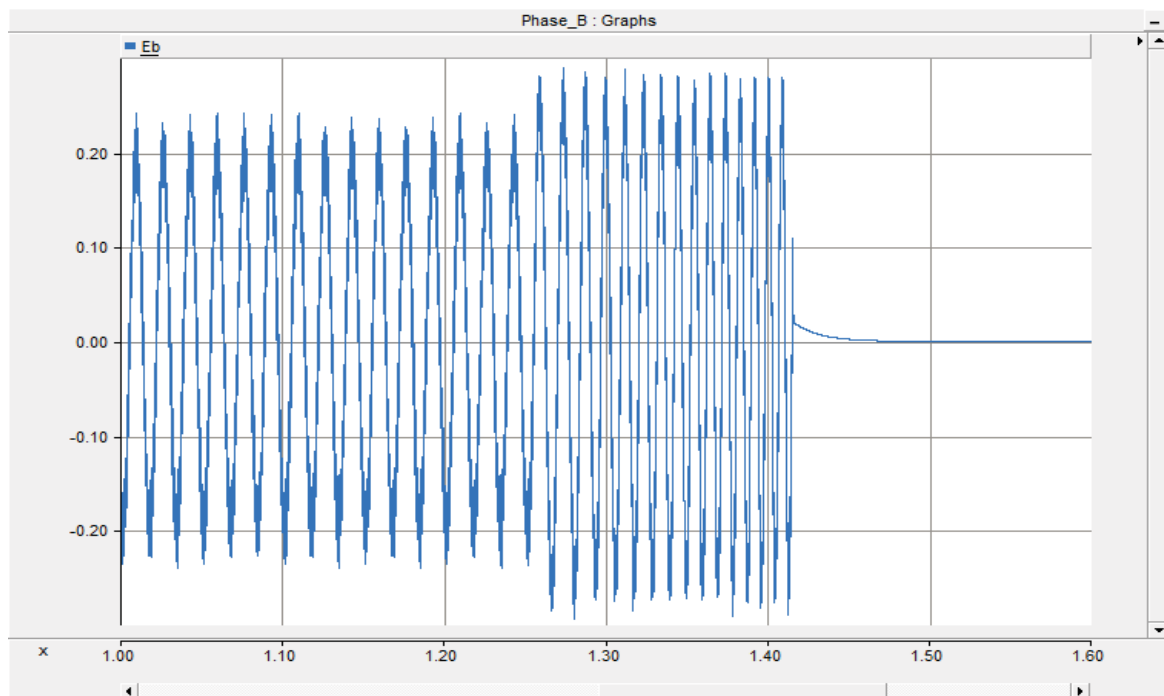

Figure 2-22. Scenario 5 – Secondary Voltage

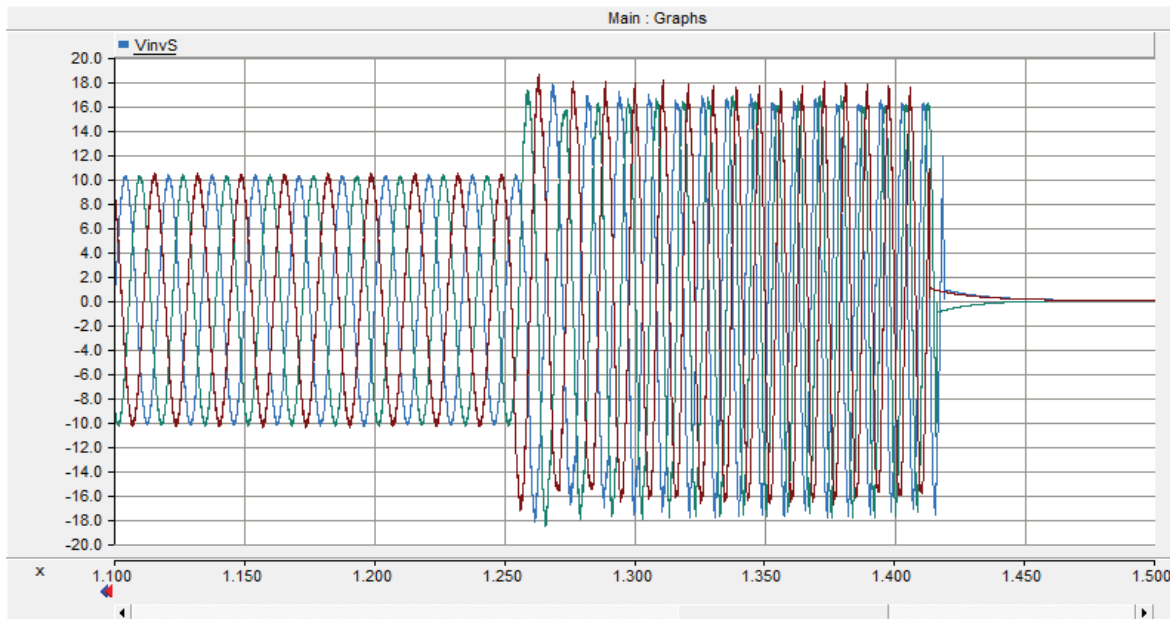

Figure 2-23. Scenario 6 – Primary Voltage

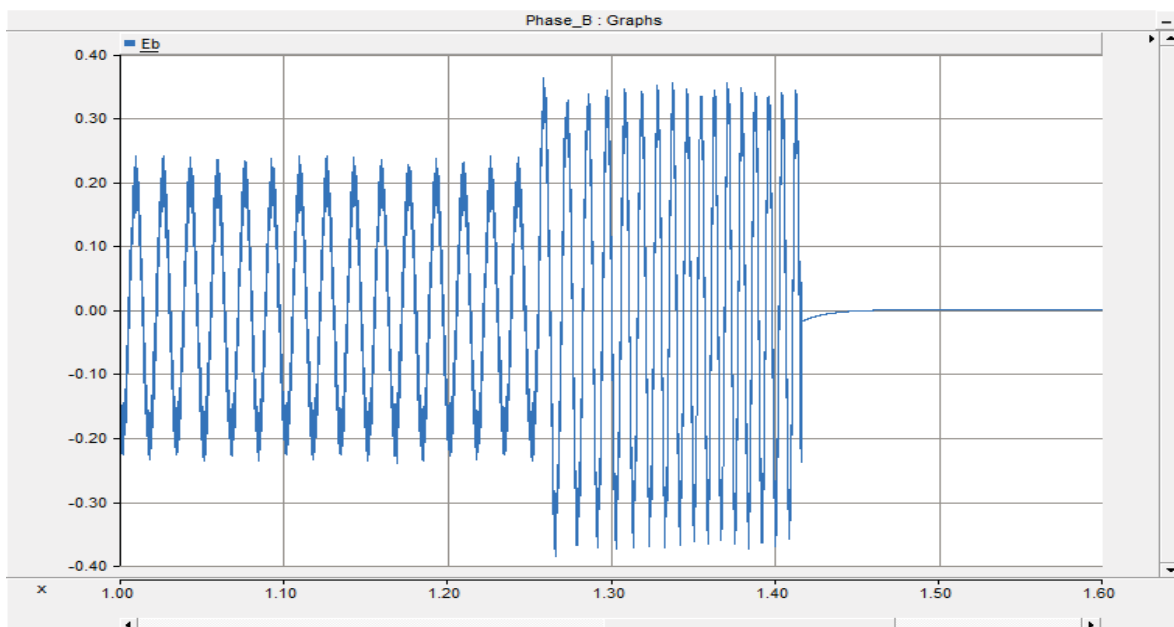

Figure 2-24. Scenario 6 – Secondary Voltage

Section 2

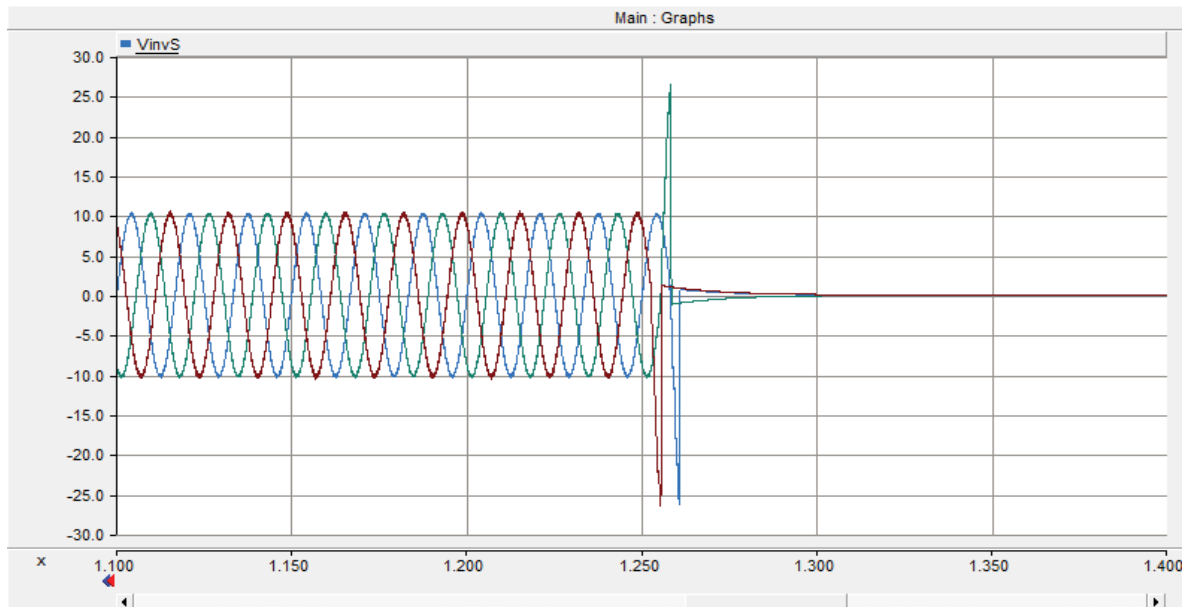

Figure 2-25. Scenario 7 – Primary Voltage

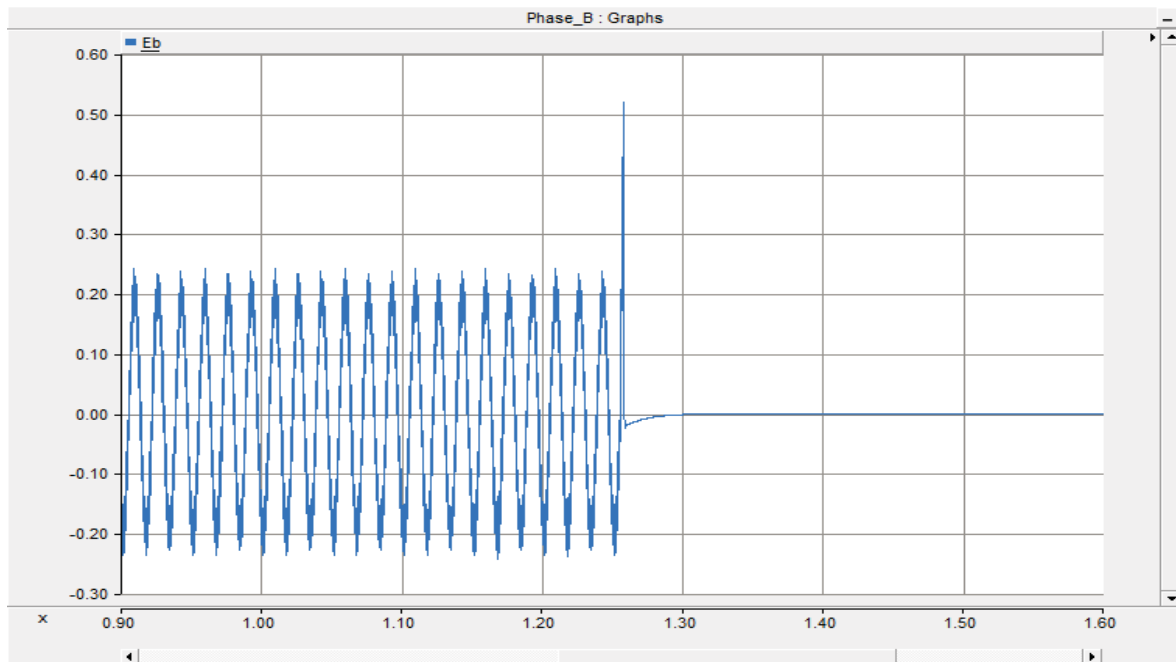

Figure 2-26. Scenario 7 – Secondary Voltage

The results indicate that frequency is the driver for the inverters shutting off in the event of a feeder outage event. For each case, frequency is greater than 60.5 Hz, which signals for the IEEE 1547 certified inverters to shut off in 0.16 seconds or 10 cycles. The exception is Scenario 7, Case 1, where the inverter fast trip technology is triggered and is offline much sooner than 10 cycles.

Penetration levels at 140% to minimum load appear to be the limit. If the Company is interested in penetration levels greater than this, requiring inverters with fast trip technology for voltage, lower than 155%, would help alleviate overvoltage concerns at higher penetration levels. Also, automatic transfer switches at customer homes with NEM PV could take the PV offline more quickly at higher penetration levels, especially for inverters without the fast trip technology.

Prior to implementing changes in policy or system operating procedures based on these results, Leidos recommends that the Company install voltage monitoring on the load side of several feeder breakers with high PV penetration to capture voltage spikes in actual load rejection scenarios. In the industry, there is not an abundance of measurements or simulations of TOV for high penetrations of NEM PV. Verifying or closely matching the results from this study could further justify any major changes the Company may pursue based on TOV concerns.

2.5 Extrapolation of Results to Company Distribution System

While the study identifies potential issues specific to the H158 and H159 circuits and the substation housing TSF-H158 and TSF-H159, it can also be used to get an understanding of the impacts of an increased level of PV penetration system-wide. The results show:

- Increased potential in required upgrades to secondary lines and service transformers
- Increased concern over voltage flicker potential
- Concern of load rejection TOV for PV to minimum load penetration levels greater than 140%

A sensitivity analysis was completed to get an understanding on how feeder impedance strength could make a difference in the voltage and capacity results. The H158 and H159 circuits have large backbone cable sizes; therefore, it takes very large increases of PV on the circuit to cause issues with capacity and voltage, as seen in this study.

However, if the backbone cable sizes were 4/0 AL underground instead of primarily 1000 AL underground, the voltage and capacity picture would look much different with increased levels of penetration. See Figure 2-27 for a comparison. The left side is the minimum load case at maximum PV penetration, 400% growth, with existing 1000 AL and 750 CU underground backbone circuit cables. The right side is the same simulation with 4/0 AL underground backbone circuit cables.

The comparison shows how voltage levels can rise with smaller primary conductor/cable sizes. This also means that voltage flicker potential and conductor loading issues could be exacerbated.

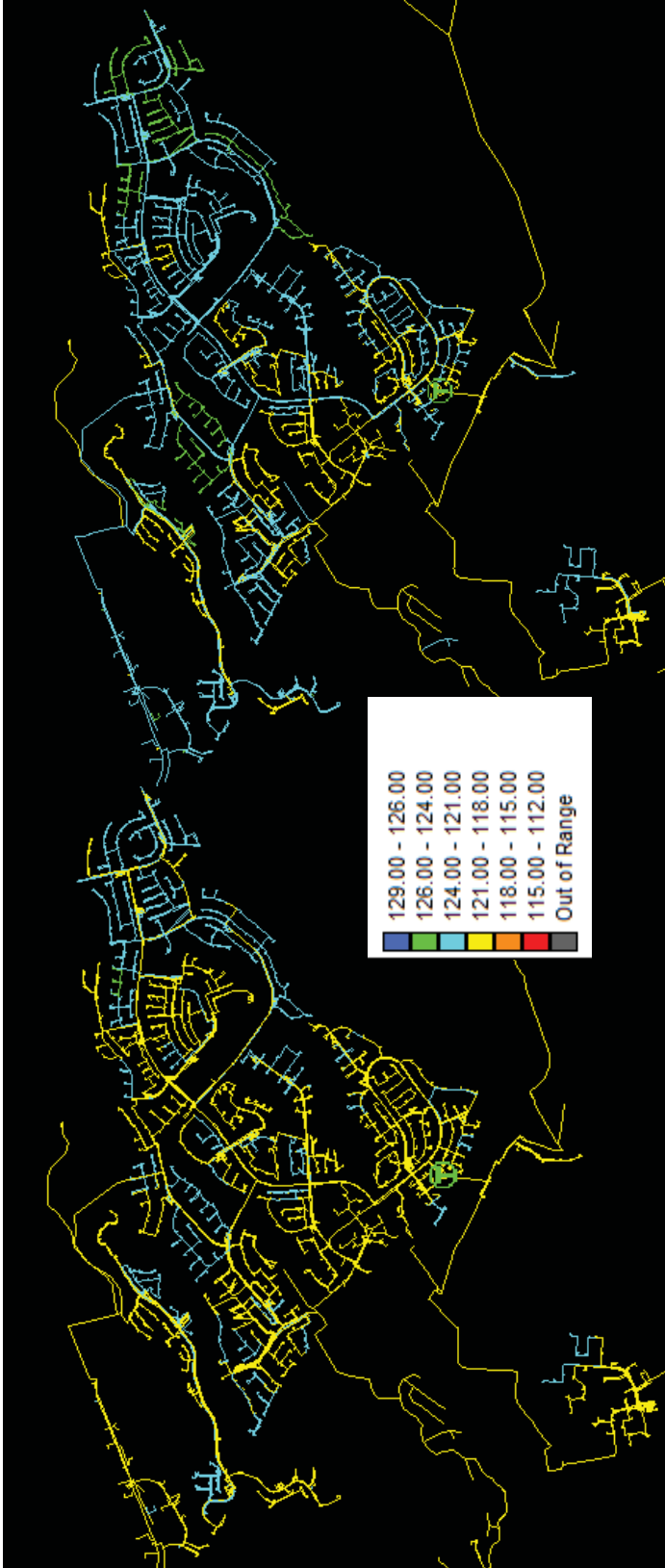

Figure 2-27. Comparison of Voltage Impacts with Variations in Circuit Impedance Strengths

Section 3

SUMMARY AND RECOMMENDATIONS

The circuit penetration study for the H158 and H159 circuits indicate that minimum load conditions identify the maximum allowable penetration of PV. More primary and secondary conductor/cable upgrades and service transformer upgrades will be required with PV growth on the distribution system. Additional monitoring locations on the distribution feeder to calculate short term and long term flicker, Pst and Plt, values are recommended to be pro-active in mitigating voltage flicker issues as PV installations increase on the system.

The limitation on the distribution system is associated with load rejection overvoltage from high NEM PV penetration levels. The TOV analysis indicates that without mitigation, levels of NEM PV penetration on distribution feeders can reach 140% penetration. Beyond that, mitigation strategies could include requiring inverters to have fast trip functionality lower than 155% or installing automatic transfer switches at NEM PV locations to trip them off-line faster than the inverter internal programmed response. Leidos recommends measuring voltages from actual load rejection events to compare to the results of the study, which will further justify any Company policy changes or system operating procedures.

Additional Considerations

The Company requested that Leidos model the capabilities of selected distribution feeders to accommodate NEM PV. To understand the systemic implications of the solar back-feed and variability at the distribution level, the Company should incorporate these results into a system level model considering transmission system reliability (congestion issues, outage issues, circuit upgrade requirements, etc.) and generation concerns (stability and dispatch issues), including the utility scale solar and wind projects. The Company should consider taking a more comprehensive view of the effect that increased levels of intermittent renewable penetration can have on stability, ramp capability or unit startup time. A holistic approach is the only way to understand fully what measures should be taken to:

- Maintain stability
- Minimize additional O&M (due to potential increases in generator cycling and lower efficiencies from operating at reduced load levels during peak renewable output periods)
- Implement curtailment structures
- Augment new utility scale PPAs with additional interconnection requirements
- Optimize installation of energy storage
- Provide solutions to mitigate increased utility operations cost while providing reliable service

Synchronous Condensers (SC) may be required to provide voltage and inertia support not received from the renewables. The Company should consider installing Synchronous Condenser (SC) at specific locations, which would be determined from further studies.

Section 3

Energy storage is a viable option, but due to the cost, the Company should perform studies to optimize the location and sizing of energy storage systems to maximize the effectiveness of this solution. Battery storage at substations or utility scale renewable installations can address ramp capability and unit startup time. Further analysis needs to be done to determine if battery storage would be able to provide MW support in case of a fast solar declamation, for instance 320 MW in 30-minutes. Installation of fast start units can also provide inertia and voltage support, as well as fast ramp and startup capabilities.

A combination of SC, battery storage and fast start units may be the most reliable and economic option. Other possibilities are DC submarine cable ties between the islands, geothermal storage, or curtailment of renewable generation, even rooftop PV, by remote control or installation limits. The Company should perform studies and implement demonstration projects of viable options.

The Company will also still need to have enough spinning reserve in order to meet its requirement for the loss of the Most Severe Single Contingency (MSSC). AES is the Company's biggest unit (201 MW) and is online most of the time due to cost; therefore, loss of the AES unit is typically the MSSC. However, if the unit is not online for any reason, the Company's MSCC will be Kahe-6 or Kahe-05, which are around 142 MW each.

In Leidos experience with other island electrical systems, integrating renewables requires this type of complete approach and the Company may find it advantageous to assess the generation profiles of the assets in the fleet as flexible ramping capability comes more critical at high penetration levels. Additionally, as the Company is aware, conversion from oil fired to natural gas generation is an effective way to reduce generation costs (in conjunction with potentially implementing generator replacements to increase efficiency of older units). For example, in Puerto Rico recent studies have shown that at high penetration levels (in Puerto Rico's case there is a significant amount of renewable capacity coming online at the transmission level) generation costs can increase to accommodate the variability of renewables.

In summary, an exponential increase in the adoption of distributed solar generating systems can lead to a number of challenges, including reliability issues, cost shifts and congestion on the grid. In addition to the technical impacts, significant PV penetration could increase the cost of service to the Company and non-PV customers due to mitigation costs, reduced revenue from Net Energy Meters to fund required infrastructure and the reduced heat rate and increased O&M of existing generators running below minimum load levels. Leidos recommends a holistic approach that considers rates and the economic as well as technical impacts of increased PV on the transmission system and existing generators as well as the distribution system and substations. This should include developing a methodology to quantify the market value of solar generation to the Company given the unique characteristics of an island grid.



**Hawaiian
Electric**

Pterra Final Report R109-14

H111-2-H-H110-1 12.47 kV Circuit Representative Study for NEM PV Penetration



Submitted to:

Hawaiian Electric Company, Inc.

August 2014

Prepared by:

Pterra Consulting

Hawaiian Electric Company, Inc.

This page intentionally left blank

Contents

<u>Executive Summary</u>	<u>1</u>
<u>Section 1. Introduction.....</u>	<u>6</u>
1.1. Description of the Study Feeder	6
1.2. Scenarios	11
1.3. Criteria	13
1.4. Approach	13
1.5. Data Bases and Computer Modeling.....	14
<u>Section 2. Feeder Load Flow Analysis</u>	<u>15</u>
2.1. Assumptions	15
2.2. Methodology	15
2.3. Load Flow Results.....	16
2.3.1. Existing Circuits	16
2.3.2. Search for Maximum Single-Phase NEM	18
2.3.3. Controller Setting for Reverse Power Flow	21
2.3.4. Loading of Fuses	22
2.4. Conclusions	25
<u>Section 3. Quasi-Steady-State (QSS) Analysis</u>	<u>26</u>
3.1. Modeling Procedure:	26
3.2. Simulation Result for a Typical Sunny Day.....	29
3.3. Cloud Movement Simulation:	33
3.4. Yearly Tap Cycling.....	42
3.5. Flicker Assessment	51
3.6. Conclusions	62
<u>Section 4. Fault Analysis and Coordination of Protective Devices</u>	<u>63</u>
4.1. Methodology	63
4.2. Fault Analysis	65
4.3. Coordination of Protective Devices.....	66
4.3.1. Time Current Curves for 12.47 kV Distribution circuit.....	66
4.3.2. Relay Response Simulations	71
4.4. Sensitivity Study with Higher Peak Current Magnitude during First-Cycle.....	72
4.5. Emergency Condition	73
4.6. Conclusions	78
<u>Section 5. Unintended Islanding.....</u>	<u>79</u>
5.1. Overview on Overvoltage Due to Load Rejection	79
5.2. Methodology and Assumptions	79
5.3. Single Phase PV PSCAD Model.....	80
5.4. Criteria	81
5.5. Analysis Results	83

5.6. Mitigation 90

5.7. TOV Mitigation with MOV 91

 5.7.1. MOV Fundamentals..... 92

 5.7.2. Failure Mode 93

 5.7.3. TOV Curve..... 94

 5.7.4. Lower Rated MOV 96

 5.7.5. Installation Considerations 96

 5.7.6. Summary of TOV Mitigation with MOV 97

5.8. Conclusions 97



Legal Notice

This report was prepared by Pterra, LLC as an account of work undertaken under the authorization of Hawaiian Electric Company (Hawaiian Electric).

Pterra, LLC, and Hawaiian Electric do not:

1. Make any warranty or representation, expressed or implied, with respect to the use of any information contained in this report, or that the use of any information, apparatus, method, or process disclosed in the report may not infringe privately owned rights.
2. Assume any liabilities with respect to the use of or for damage resulting from the use of any information, apparatus, method, or process disclosed in this report.

The report is confidential and proprietary to Pterra, LLC and Hawaiian Electric and may not be copied, duplicated, or loaned or transferred to a non-designated party without the express written permission of Pterra, LLC and Hawaiian Electric.

Executive Summary

Pterra, LLC ("Pterra") conducted this study per the Work Authorization of Hawaiian Electric Company, Inc. ("Hawaiian Electric"). The objective of the study is to determine the impact of future Net Energy Metering (NEM) PV growth and establish a maximum PV penetration on the H111-2 12.47 kV circuit for the following technical aspects: steady-state feeder power flow, quasi-steady-state (QSS), protective relaying, and unintended islanding¹.

There are NEM and FIT systems already proposed and installed on H111-2 Circuit.

Key Findings and Proposed Mitigation

1. Steady-state power flow analysis indicates the maximum penetration level for single-phase NEM units on the H111-2 and H111-1 circuits is found to be 4179 kW. However, after considering the effects of load and irradiation profile as well as shadow movement, the penetration level for single-phase NEM should be limited to about **3223 kW**. This reduction keeps voltage imbalance close to the limits recommended by NEMA MG1-1993, which applies to generators and motors.
2. Yearly simulation suggests 185% incremental tap cycling due to 3223 kW single phase NEM units. Hawaiian Electric may need to evaluate the maintenance and operation procedure for the LTC to prevent premature damage.
3. The LTC reverse setting should be set as "ignore". Setting the LTC as lock-to-neutral would significantly increase tap cycling.
4. Yearly simulation demonstrates that both of short and long term voltage flicker stay within the IEEE Std. 1453 limits after addition of 3223 kW NEM PV.
5. From transient simulations of single phase inverter with different level of loading, the maximum TOV magnitude could be about 162%. The inverter should trip within 0.15 cycles in order to be within the acceptable level of the ITIC curve. If the inverter fails to trip within the time frame, there is potential damage to sensitive customer loads. Here are several options to mitigate potential damage to sensitive customer loads:

Mitigation on Inverter Unit

¹ Analysis limited to transient over voltage. Sustainable islanding is not covered in this study

- In addition to the overvoltage setting required by IEEE 1547, an additional high overvoltage setting with a very fast trip should be applied to single phase inverters (third stage setting). This setting should be set about 140 – 150% of nominal peak voltage and should use instantaneous detection instead of RMS detection. The 140-150% would cause less potential nuisance trip due to switching events and instantaneous detection would allow faster response (less than a cycle).
- Software Protection. Shorten the overvoltage duration through software/firmware modifications for existing inverters that are already installed on the circuit. For example a manufacturer was able to shorten the TOV from 3 cycles to about 0.5 cycle² and then surge suppressor can be used to clamp the rest of overvoltage³. It is expected that this approach can significantly reduce the risk to the electric devices. This approach can be implemented for existing PV units on the circuit.
- Utilize MOV (Metal-Oxide Surge Arresters) near the inverter.

Adjust the Protection to Avoid Islanding Event

- Disable the fast curves of the phase and ground sensor of the recloser to reduce exposure to transient overvoltages. A fault that leads to islanding of the feeder with the DG remaining online could cause TOV on the feeder. Disabling the fast curves allows the DG to trip ahead of recloser such that, if and when, islanding occurs, the DG will already be offline. The fast curves are generally used in fuse saving scheme.
- Disable instantaneous overcurrent function on the substation breaker. Similar to the above discussion, disabling the instantaneous element allows the DG to trip ahead of the substation breaker and therefore would reduce islanding event. The instantaneous is generally enabled for fuse saving scheme.

2 R. J. Bravo, R. Yinger, S. Robles and W. Tamae "Solar PV Inverter Testing for Model Validation", Power and Energy Society General Meeting, 2011 IEEE, 24-29 July 2011, San Diego, CA, pp 1 - 7

3 F. J. Pazos, E. Navarro, "Field experience of Power Frequency Overvoltages in Wide-Scale Photovoltaic Systems", Integration of Wide-Scale Renewable Resources Into the Power Delivery System, 2009 CIGRE/IEEE PES Joint Symposium, 29-31 July 2009, pp 1

Note that the H111-2 and H110-1 circuits do not have instantaneous overcurrent function on the substation breaker and do not have recloser fast curves.

Modify the Operation

- Monitor the reverse power flow on the feeder substation. If major reverse power flow occurs, PV units could be curtailed. In this case, strategies similar to demand response could be used; for example, incentivizing curtailed PV units. This could avoid expensive mitigation cost.
- Reconfigure the circuit in such a way that most of the load could be retained when islanding event occurs. This could be done by relocation of recloser or other interrupting devices.

Battery Storage

- Inverter based battery storage could be used to increase the loading level during noon time when the PV units generates near their full capacity by charging the battery during day time and discharging it during night-time when PV units do not generate.

Future Works

- This study covers maximum NEM PV penetration on the primary distribution level; future work should be performed to cover maximum PV penetration on low voltage service level (i.e. single phase service transformer 7200/2400 volt). Specifically, the study should also determine the maximum PV penetration limit on service transformer that directly feeding the customer.
- Significant Reverse power flow / back-feed from multiple substation transformers could negatively impact sub-transmission and transmission system and therefore should be studied if this event is expected in the near future.

Summary of Findings for Each Task

Below are conclusions from each task of the study:

Load Flow Analysis

- The maximum penetration level for single-phase NEM units is found to be 4179 kW on the study feeders:
 - a. A total of 4179 kW of single-phase NEM units could be added to the study feeders without causing violations regarding voltage regulation, thermal loading of substation transformer or feeder conductors, voltage imbalance level or sensitivity of ground protection.
 - b. The LTC/LDC controller setting should be set as "ignore" for reverse power flow.
 - c. This penetration level and reverse power mode is based on steady state load flow only. This level has to be further checked with quasi-steady state analysis.
 - d. The existing fuses are able to withstand the increased thermal flow due to the addition of the NEM units.

Quasi-Steady-State Analysis

- Daily/yearly QSS analysis was conducted to demonstrate impending effects of load and irradiation profile as well as shadow movement. Considering simulation results, NEM penetration limit suggested in section 2 (i.e. 4179 kW) needs to be further reduced to 3223 kW. This reduction keep voltage imbalance close to the limits recommended by NEMA MG1-1993.
- The impact of unbalance current caused by single phase PV penetration of about 3223 kW would not negatively affect ground relay performance at the substation and would not negatively affect the ground protection performance for recloser.
- Considering yearly/daily simulations, Project (3223 KW NEM) is not likely to cause voltage flicker violation.

Fault Analysis and Coordination of Protective Devices

- The existing protective devices on the study feeders at the 12.47 kV level are well coordinated.
- With a total of 4179 kW NEM units added on the study feeders, the fault current wouldn't violate the rating of the interrupting devices. With the assumption of 2 times rated current for NEM units, the maximum fault current increase is 144 A at 12.47 kV. The clearing time of the protective devices is not significantly impacted with the NEM units online. The NEM units could change the existing clearing

time for about 1.5 cycles. Therefore, the study feeders are capable of accommodating the 4179 kW NEM units.

- A sensitivity study is performed which assumes a fault current as high as 7 times rated current of the NEM units. This could give a maximum of 485 A fault current contribution from the NEM units and could change the clearing time for about 3.5 cycles which is still insignificant
- During emergency condition I when part of H111-2 Circuit is fed from TSF-H110, the NEM units (about 3043 kW) will not impact the existing coordination.

Unintended Islanding

- Pterra created a PSCAD model for single phase PV that closely matched a manufacturer load rejection test. The model was then used to test different scenarios.
- From transient simulations of single phase inverter with different level of loading, the maximum TOV magnitude could be as high as 162%. The inverter should trip within 0.15 cycles in order to be within acceptable level of the ITIC curve. Although some inverter manufacturers claim to be able to trip within less than 0.1 cycles or no delay, this claim needs to be independently verified. Similarly, another manufacturer mentioned that its PV inverter has the ability to stop exporting power when a voltage transient is detected; Hawaiian Electric may need to verify this capability.
- Some mitigation measures are proposed as mentioned in Key Findings above.

Section 1. Introduction

Pterra, LLC ("Pterra") conducted this study per the Work Authorization of Hawaiian Electric Company, Inc. ("Hawaiian Electric"). The objective of the study is to determine the impact of future Net Energy Metering (NEM) PV growth and establish a maximum PV penetration on the H111-2 and H111-1 12.47 kV circuits for the following technical aspects: steady-state power flow, quasi steady-state, protective relaying, and unintended islanding.

There are NEM and FIT systems already proposed and installed on H111-2 Circuit.

This report documents the results of the study, and includes the following sections:

- Introduction. This section presents a background of the study, the development of data bases and computer models, detailed description of the circuits under the study which include existing PV units, loading during heavy and light load conditions, and single line diagrams.
- Load Flow Analysis. This section provides background, assumptions, methodology and criteria used for the assessment as well as recommendations and conclusions from the point of view of voltage regulation, thermal loading and power loss.
- Quasi-Steady-State (QSS) Analysis. This section illustrates impending effects of variable load, irradiation profile and shadow movements. Yearly QSS analysis is conducted in this section to demonstrate Project's contribution from tap cycling point of view.
- Fault Analysis and Coordination of Protective Devices. This section presents the short circuit analysis and includes the short circuit results before and after PV units are added. Existing relay setting, time-current-curve (TCC) plots and a review of the settings are also provided. The impact of the PV units on the protective relay scheme and coordination are also discussed.
- Islanding Assessment. This section presents the assessment of islanding issues related to load rejection overvoltage.

1.1. Description of the Study Feeder

TSF-H110/H111 substation is located on the west shore of Oahu, as illustrated in Figure 1-1. Figure 1-2 shows one line diagram of the 12.47 kV feeders of TSF-H110/H111 substation. H111-2 Circuit and H111-1 Circuit are fed from TSF-H110/H111 substation transformer TSF-H111 which is rated 43.8/13.09 kV, 10/12.5 MVA, and is delta-wye connected with solidly

grounded neutral. There is a 3.6 Mvar capacitor bank connected at H111-1 Circuit.

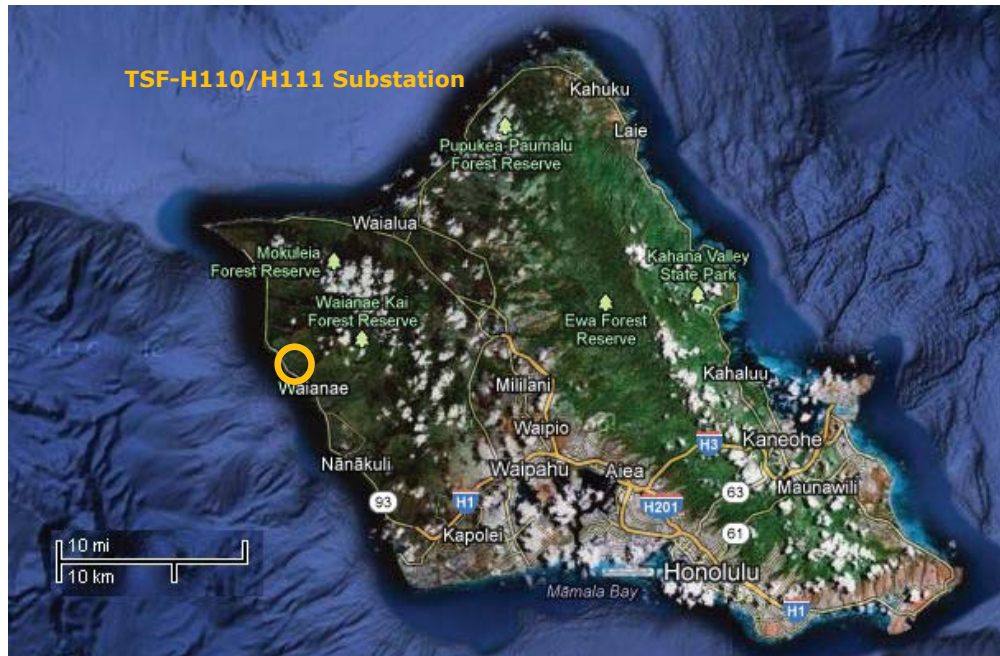

Figure 1-1: Approximate Location for TSF-H110/H111 Substation on the Island of Oahu

TSF-H110/H111 substation transformer TSF-H110 is also rated 43.8/13.09 kV, 10/12.5 MVA, and is delta-wye connected with solidly grounded neutral. TSF-H110 feeds H110-1 Circuit. There is a 3.6 Mvar capacitor bank connected at H110-1 Circuit.

TSF-H110 and TSF-H111 are equipped with line drop compensators (LDC) for voltage regulation.

The estimated gross loads by feeder are summarized in Table 1-1. A power factor of 0.9 is assumed for all the loads.

At the 46 kV sub-transmission level, TSF-H110 is fed from the North-South 46 kV line and TSF-H111 is fed from East-West 46 kV line during normal condition. Please refer to Figure 1-3 for the one-line diagram at 46 kV level provided by Hawaiian Electric.

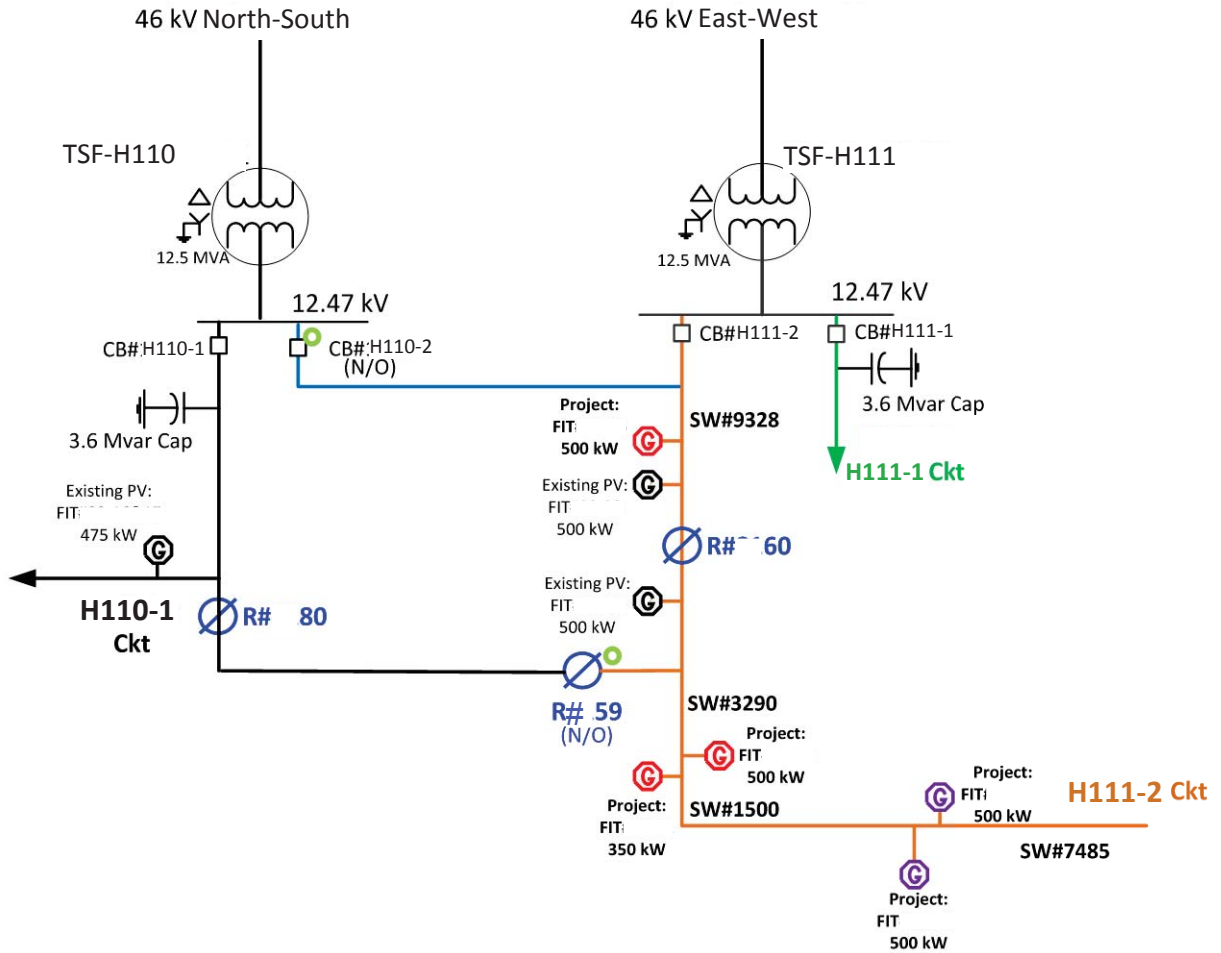

Figure 1-2: One Line Diagram of H111-2, H111-1 and H110-1 Circuits (Existing Residential PV Units Are Not Shown)

Table 1-1: Summary of Gross Load by Feeder (Source: Hawaiian Electric)

Transformer	Circuit	Peak (kVA)	Light (kVA)
TSF-H110			
	H110-1 Circuit	6262	2504
	H111-2 Circuit (Standby)	0	0
TSF-H111			
	H111-2 Circuit	6221	3654
	H111-1 Circuit	3709	1483

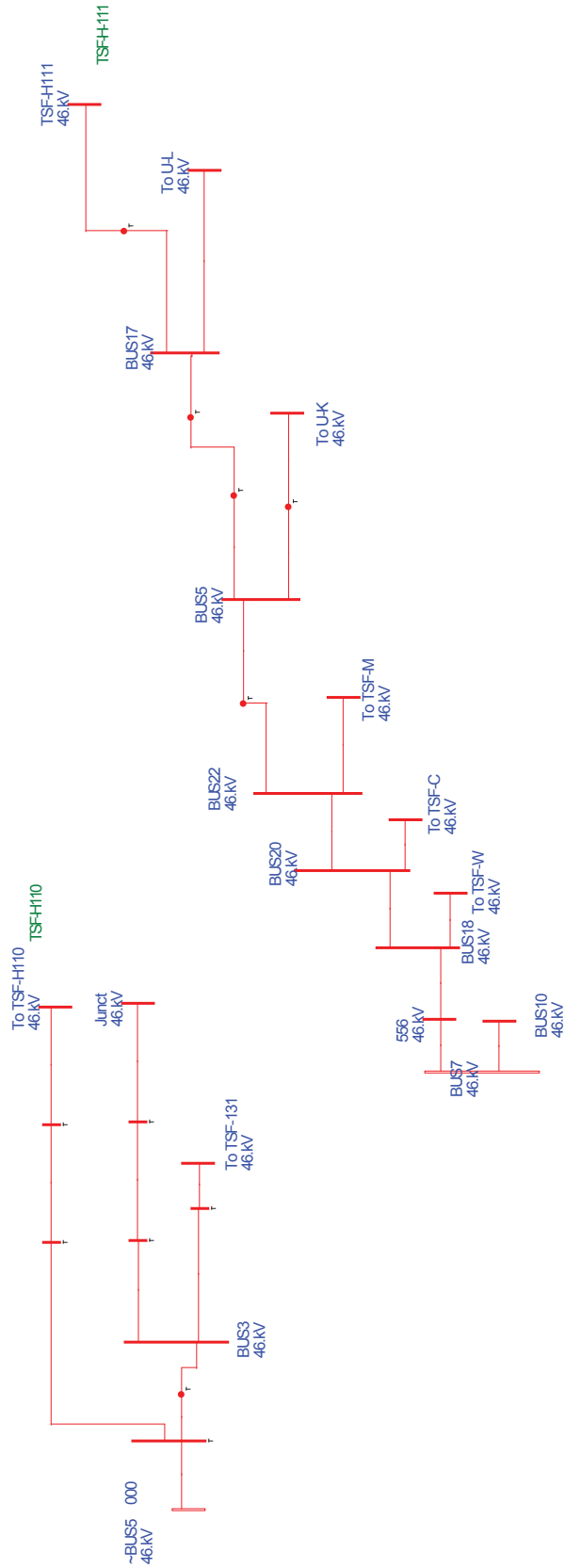

Figure 1-3: One-Line Diagram of the 46 kV Level

H111-2, H111-1 and H110-1 Circuits are mainly composed of overhead lines. The H111-2 Circuit is a bifurcated feeder as illustrated in Figure 1-4; the majority of load is located on "H111-2 path 1", spanning southeast of the TSF-H110/H111 substation.

The feeders use a four-wire, three-phase and one-neutral system. The fourth or neutral wire of each feeder has multiple grounds allowing single-phase loads to be connected between the phase and the neutral.

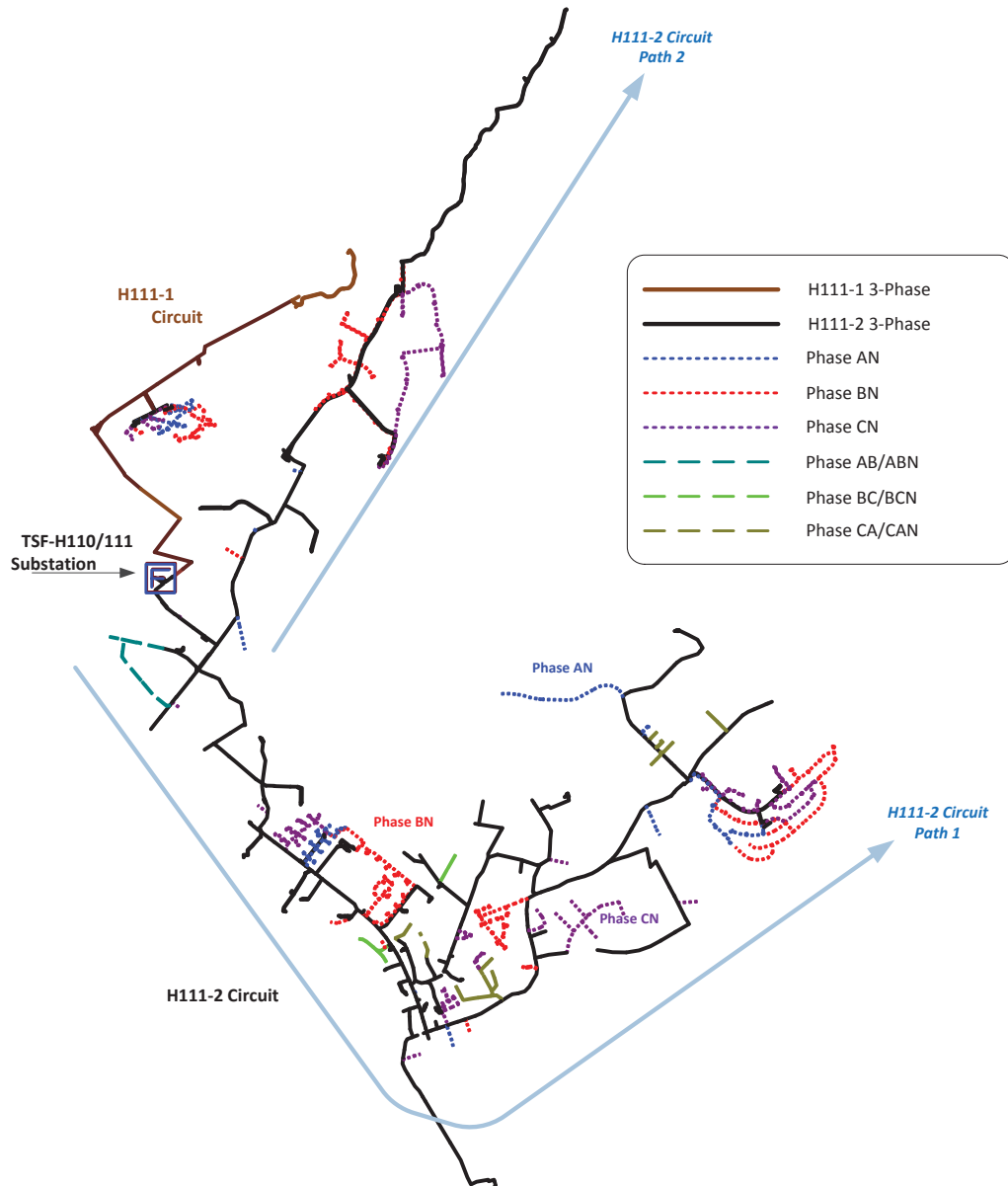

Figure 1-4: Main Paths of H111-2 Circuit and H111-1 Circuit

1.2. Scenarios

Depending on the operation of the loop feed reclosers (Rec#80, 59 and 60), there are three circuit conditions studied in this report:

- **Normal Condition:** Reclosers 59 is open while reclosers 60 and 80 are closed. Refer to Figure 1-5.
- **Emergency Condition I:** Recloser 60 is open while Reclosers 80 and 59 are closed. Refer to Figure 1-6.
- **Emergency Condition II:** Recloser 80 is open while Reclosers 60 and 59 are closed. Refer to Figure 1-7.

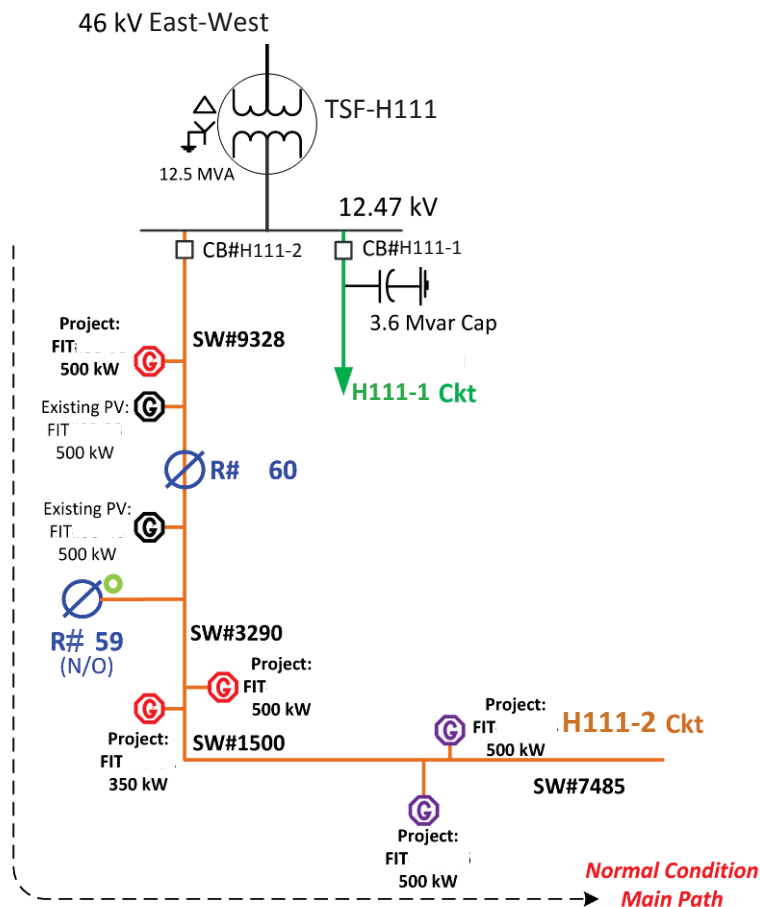

Figure 1-5: Main Path of Normal condition

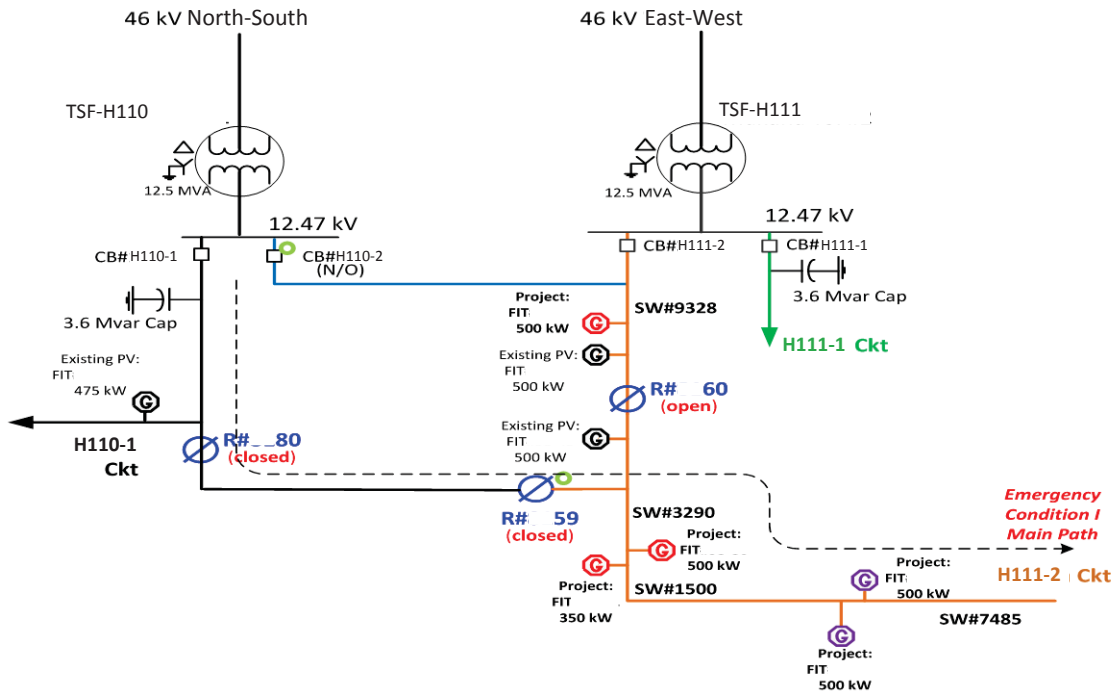

Figure 1-6: Main Path of Emergency Condition I

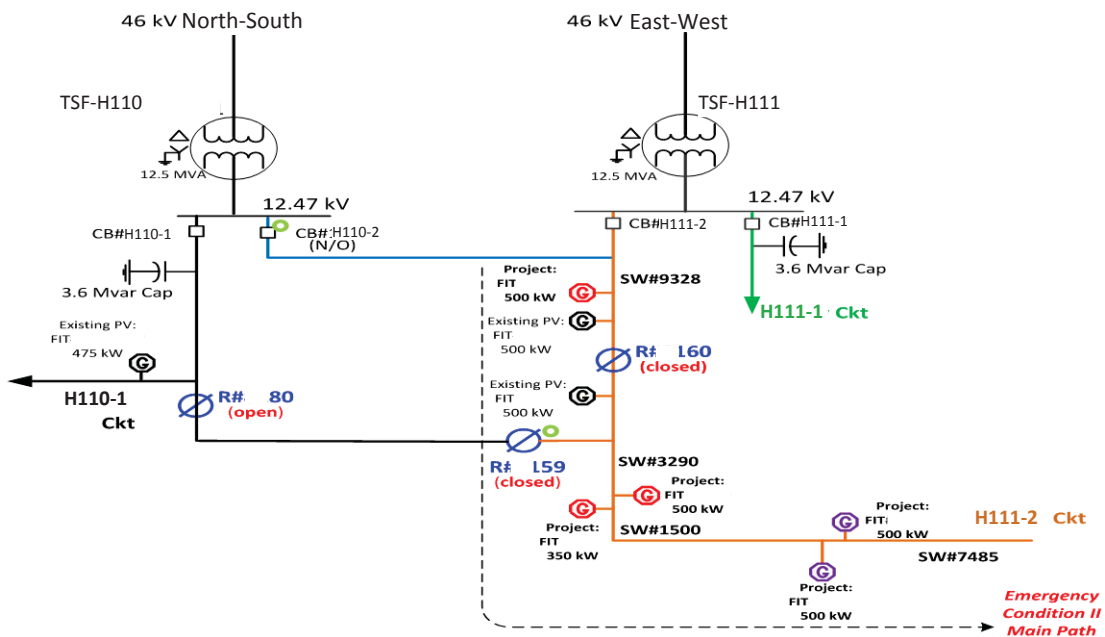

Figure 1-7: Main Path of Emergency Condition II

Note that emergency scenarios were performed in Fault Analysis and Coordination of Protective Devices. For QSS, Simulation results

demonstrated that tap cycling, voltage imbalance and ground current are mainly governed by penetration level of single-phase NEM units. Therefore, from QSS point of view, normal operation is more severe than both emergency scenarios as the penetrations are higher (more load in emergency condition I and less NEM KW in emergency condition II). Similarly for steady state load flow, the normal scenario is more severe than emergency condition as it has the highest PV/Load ratio.

1.3. Criteria

The allowable circuit NEM penetration is determined on the basis that the following criteria are not violated:

1. Steady-state voltage remain within ANSI Range A limits
2. Temporary voltages, caused by PV variations prior to completion of tap movement shall be within ANSI Range B limits.
3. Thermal capacity of conductors and the substation transformer should not be violated.
4. Voltage imbalance remains within NEMA MG-1-1998 limits: 1% voltage imbalance for motor loads. It is also noted that ANSI C84.1 recommends a maximum of 3% voltage imbalance when measured at the electric utility revenue meter.
5. Current imbalance does not trigger ground relay of substation transformer.
6. The incremental tap cycling, on an estimated cumulative annual basis, should not exceed a specified number of operations per regulator, per typical day. Hawaiian Electric shall define this critical number of operations.

1.4. Approach

For the normal circuit configuration, the following approach is used:

Step 1) Utilizing SynerGEE power flow, find the maximum penetration level which does not cause voltage and/or thermal violations. In this step, lateral branches are considered and all single-phase PV units inject power into the feeder. The power injected from each point is linearly proportional with connected kVA. All of the units operate at full capacity. Growing PV as a percentage of connected kVA forecasts all customers on a circuit will install PV.

Step 2) Run QSS analysis for penetration level calculated in Step 1 and monitor criteria#4 and 5. If no violation is observed, penetration level calculated in Step 1 is the final limit. Otherwise, penetration level is reduced and QSS analysis is repeated until all of the observed

violations disappear. This penetration level represents feeder penetration limit.

Step 3) In parallel with QSS analysis, TOV and protection studies are carried out to assess the penetration level determined in Step 1. Similar to Step 2, penetration level is adjusted until there is no violation.

Step 4) The maximum NEM penetration level of H111-2 and H111-1 Circuits is determined from QSS, TOV, and protection analyses in Step 2 and Step 3.

The study circuits have to comply with the Criteria under normal condition and emergency conditions. Therefore, the maximum NEM penetration level determined from normal condition is assessed at emergency condition. In case of violation, the NEM penetration level is further adjusted.

1.5. Data Bases and Computer Modeling

A SynerGEE database of H111-2, H111-1, and H110-1 Circuits was provided by Hawaiian Electric. Pterra allocated the gross light load based on the connected kVA of service transformers on each feeder and added TSF-H110/H111 substation transformers TSF-H110 and TSF-H111 to the SynerGEE model. Existing FIT PV units are modeled as PQ generators. NEM units are modeled as negative spot loads. All of the PV units are modeled at full output with unity power factor.

SynerGEE is used for the load flow study which covers thermal and voltage analyses.

The SynerGEE model and database are then transferred to OpenDSS and Aspen software package for quasi-steady state analysis and protection assessment, respectively.

A single-phase PV inverter model is developed with PSCAD for transient studies.

For load flow analyses, an equivalent model comprising of a three-phase source at the 46 kV side of the distribution substation transformer (46/12.47 kV transformer) is applied; the detailed model does not affect the analysis of the subject projects located on the 12.47 kV network. For protection assessment in the Aspen software package, the feeders are tapped to the transmission model provided by Hawaiian Electric.

Section 2. Feeder Load Flow Analysis

This section presents the steady state feeder load flow analysis, including voltage regulation and thermal analysis.

2.1. Assumptions

The following assumptions are made for the steady state load flow:

1. Only single-phase NEM units are considered.
The assumption is made because most of the NEM units are single-phase and less than 10 kW. It is also a conservative assumption because single-phase NEM could create voltage and current imbalance which limits PV penetration level.
2. The hard limit is defined as the thermal limit of substation transformer. It can't be violated in this study.
3. The soft limit is defined as the thermal limit of the existing service transformers and conductors. The soft limit could be exceeded by adding new transformers or upgrading the conductors.
4. Within the soft limit, NEM units are no larger than 80% of the connected kVA size of the service transformers and are no larger than 100 kW in size.
5. The existing NEM units are not modeled in detail because they are included in the modeling process by assuming a maximum of 80% connected kVA (c.kVA) at each service transformer.

2.2. Methodology

Light load condition under various PV scenarios is studied for steady state load flow. It is more conservative than the peak load condition because higher amounts of reverse power flow on the circuits could trigger voltage and thermal issues.

The maximum PV penetration level within the soft limit is studied first. It serves as a starting point for finding maximum NEM penetration. If there is no voltage or thermal violation at 80% c.kVA, the NEM units are increased by 15% until they overload the substation transformer or cause voltage/thermal violations. Conversely, if the 80% c.kVA case presents a violation, the NEM units are reduced by 15% until voltage/thermal violations disappear.

Voltage regulation of the study circuits is mainly obtained via the LTC/LDC controller installed on substation transformer TSF-H111 which is summarized in Table 2-1. The load flow is performed assuming the substation LTC/LDC

controller is digital and the reverse mode is set as 'ignore'. This setting is recommended by Beckwith for feeders with DG⁴. A sensitivity study is performed to compare the voltage performance with different reverse power flow modes in Section 2.3.3.

The study feeders are monitored for voltage performance and thermal loading level for various scenarios. Voltage imbalance percentage and neutral current are also monitored. The criteria used to determine whether there is a violation are listed below:

1. Phase voltage throughout the primary feeder should stay within +/-5% of the nominal voltage of 12.47 kV for three phase or 7.2 kV for single phase.
2. Thermal loading should not exceed 100% of the conductors' continuous rating. Otherwise, upgrade of conductors is recommended.
3. Voltage imbalance should stay within 1%. This is to ensure the existing motors don't have to be de-rated⁵. This criterion applies to three phase motor loads and is less of a concern for three-phase non-motor loads. It is noted that ANSI standard C84.1 allows up to 3% voltage imbalance.
4. Neutral current should stay below the pick-up current of ground protection which is about 300 A for circuit breaker H111-2 at TSF-H111.

Table 2-1: LDC Settings (Unit: V)

Transformer	R	X	Bandwidth	Running Voltage	Base Voltage
TSF-H111	4	4	2	122	120

At the end, the fuses are also checked to see if the addition of future NEM units will overload the existing fuses on the circuits.

2.3. Load Flow Results

2.3.1. Existing Circuits

Scenario#1 and Scenario#2 as summarized in Table 2-2 study the performance of the existing circuits without any PV and with the 3350 kW FIT units at full output, respectively. This is to find if there is any existing violation on the study feeders.

⁴ Beckwith Electric M-2001C Tapchanger Control Instruction Book

⁵ A von Jouanne and B Banerjee, Assessment of Voltage Unbalance, IEEE Transaction of Power Delivery, Vol.16, No.4, pp. 782-790, 2001

Table 2-3 summarizes the load flow results of these two scenarios on the main paths of H111-2 and H111-1 Circuits. The maximum and minimum phase voltage, the maximum voltage imbalance level, the maximum thermal loading throughout the study feeders including main paths and lateral branches are also summarized at the bottom of the table.

Table 2-2: Steady State Load Flow Analysis for the Existing Circuits

Scenario#	FIT (kW)	Single-Phase PV		Total PV (kW)
		% of 1-P TSF c.kVA	1-P NEM (kW)	
#1	0	0	0	0
#2	3350	0	0	3350

Table 2-3: Steady State Load Flow Results for Scenario#1 and Scenario#2

Scenarios		Scenario#1				Scenario#2					
Description		light load				light load + FIT					
Makaha TSF2 Tap Position		4L				5L					
TSF reverse mode		ignore				ignore					
TSF loading		54% / 43%				27% / 21%					
TSF demand		kW	4774	kVA	5397	kW	1395	kVA	2679		
PV (kW)		FIT	0	NEM	0	FIT	3350	NEM	0		
section	mi	conductor		Vol (p.u.)	V imb%	loading%	3Io (A)	Vol (p.u.)	V imb%	loading%	3Io (A)
Section_00	0.00	750 Cu UG 15kV 3/C PILC		1.030	0	52	0	1.026	0	26	0
254929	0.01	750 Cu UG 15kV 3/C PILC		1.030	0	37	0	1.026	0	15	0
254871	0.20	336.4 AAC OH		1.029	0	33	0	1.026	0	14	0
254855	0.36	336.4 AAC OH		1.027	0	33	1	1.025	0	14	1
255055	0.47	336.4 AAC OH		1.025	0	28	8	1.024	0	14	8
255027	0.89	336.4 AAC OH		1.021	0	27	6	1.022	0	14	6
255252	1.27	336.4 AAC OH		1.017	0.1	27	6	1.020	0.1	13	6
d255339	1.37	4/0 ACSR OH		1.016	0.1	40	5	1.020	0.1	19	5
255382	1.58	336.4 AAC OH		1.013	0.1	25	4	1.018	0.1	13	4
255895	1.93	336.4 AAC OH		1.010	0.1	21	7	1.016	0.1	10	7
255849	2.12	336.4 AAC OH		1.009	0.1	19	3	1.015	0.1	9	2
256310	2.21	336.4 AAC OH		1.008	0.1	19	6	1.015	0.1	10	6
256404	2.40	336.4 AAC OH		1.007	0.1	17	5	1.014	0.1	8	5
257091	2.46	336.4 AAC OH		1.006	0.1	14	6	1.014	0.1	8	6
51111400	2.62	336.4 AAC OH		1.006	0.1	11	3	1.014	0.1	5	3
51066057	2.78	336.4 AAC OH		1.005	0.1	11	4	1.013	0.1	5	4
256977	3.07	336.4 AAC OH		1.004	0.1	10	5	1.013	0.1	4	5
256959	3.32	336.4 AAC OH		1.003	0.1	10	6	1.012	0.1	4	6
258647	3.60	336.4 AAC OH		1.002	0.1	5	0	1.011	0.1	2	0
258588	3.86	336.4 AAC OH		1.001	0.1	5	0	1.011	0.1	5	0
258450	4.25	336.4 AAC OH		1.001	0.1	4	4	1.011	0.1	4	4
258385	5.12	3/0 AAAC OH		1.000	0.1	0	0	1.010	0.1	0	0
254822	0.50	336.4 AAC OH		1.026	0	6	7	1.024	0	6	7
254909	0.81	#4 Cu OH		1.025	0	18	8	1.023	0	18	8
254760	0.96	#4 Cu OH		1.024	0.1	18	8	1.022	0.1	18	8
255649	1.80	#2 Al UG 15kV PEICN (2)		1.022	0.2	4	4	1.020	0.2	4	4
255449	2.45	#2 Al UG 15kV PEICN (2)		1.021	0.2	2	0	1.020	0.2	2	0
256497	2.78	#2 Al UG 15kV PEICN (2)		1.021	0.2	2	0	1.019	0.2	2	0
245866	3.57	#2 Al UG 15kV PEICN (2)		1.021	0.2	1	0	1.019	0.2	1	0
254933	0.01	750 Cu UG 15kV 3/C PILC		1.030	0	15	0	1.026	0	15	0
254935	0.06	750 Cu UG 15kV 3/C PILC		1.030	0	15	0	1.026	0	15	0
254773	0.50	336.4 AAC OH		1.028	0	13	2	1.024	0	13	2
254620	1.28	336.4 AAC OH		1.024	0	10	6	1.020	0	10	6
254503	1.95	336.4 AAC OH		1.023	0	1	1	1.019	0	1	1
51083857	2.51	#2 Al UG 15kV PEICN (2)		1.023	0	3	0	1.019	0	3	0
all feeder max				1.030	0.2	52		1.026	0.2	26	
all feeder min				0.999				1.009			

The voltage is in the range of 1.0 p.u. to 1.02 p.u. for both cases which is within the criteria. The maximum thermal loading is 52%. Voltage is well balanced and there is no neutral current flowing through the substation transformer. There is no violation on the existing circuits.

2.3.2. Search for Maximum Single-Phase NEM

As a starting point to search for maximum penetration, single-phase NEM units, 80% of c.kVA at each of the service transformer which is 9562 kW, are

added to the study feeders. This is Scenario#3 and violations are found with the added NEM. Therefore, the single-phase NEM is reduced by 15%. The scenarios are summarized in Table 2-4.

Table 2-4: Scenarios for Steady State Load Flow Analysis with Single-Phase NEM

Scenario#	FIT	Single-Phase PV		Total PV
		% of 1-P TSF c.kVA	1-P kW	
3	3350	80%	9562	12912
4	3350	65%	7765	11115
5	3350	50%	5977	9327
6	3350	35%	4179	7529
7	3350	20%	2391	5741
8	3350	5%	598	3948

Table 2-5 summarizes the load flow results for Scenario#3 through Scenario#6.

For Scenario#3 when a total of 9562 kW single-phase NEM are added to the existing circuits, voltage is in the range of 1.0 p.u. to 1.05 p.u. There is a thermal loading violation and voltage imbalance level exceeds the 1% criteria. Neutral current is 124 A which is below the pickup threshold of ground protection.

When single-phase NEM is reduced to 7765 kW in Scenario#4, there is still voltage imbalance up to 1.7%. When NEM is further reduced to 5977 kW in Scenario#5, voltage imbalance is up to 1.4%. There is no violation on voltage regulation, thermal loading or impact on ground protection sensitivity. Scenario #6, with a total of 4179 kW NEM, all criteria is met.

Therefore, the maximum single-phase NEM that could be installed on the study circuits is 4179 kW. At this penetration level, substation transformer TSF-H111 is loaded to 37%, and the feeders could back feed the sub-transmission system to a maximum of 4476 kW.

2.3.3. Controller Setting for Reverse Power Flow

The setting of LTC/LDC controller for reverse power flow condition could impact the voltage performance on the circuits. Beckwith recommends two settings for reverse power flow: *ignore* and *distributed generation*. The logic of these two settings is the same, which regulates a certain point on the distribution feeder to avoid overvoltage. The only difference is that the setting of *distributed generation* allows a different setting for R and X while the *ignore* setting uses the same setting as that of forward mode.

Originally, the controller for substation TSF-H110 is analog and the setting for reverse power mode is locked.

Figure 2-1 shows the voltage profile along H111-2 Circuit Path 1. The first 6 curves in the legend are the voltage performance for Scenario#1 through Scenario#6 with the reverse mode set as *ignore*. The last curve (purple) is Scenario#6 with LTC locked for reverse mode. With the *ignore* setting, the tap position is at 7L or 8L with NEM units ranges from 80% to 35% of the c.kVA of single-phase transformers. This reduces the voltage on the feeder to no more than 1.03 p.u. For a total of 4179 kW NEM units, with the tap locked at 4L for reverse flow, the voltage is around 1.035 p.u. on the feeder. This is higher than the voltage in Scenario#6 that is around 1.015 p.u.

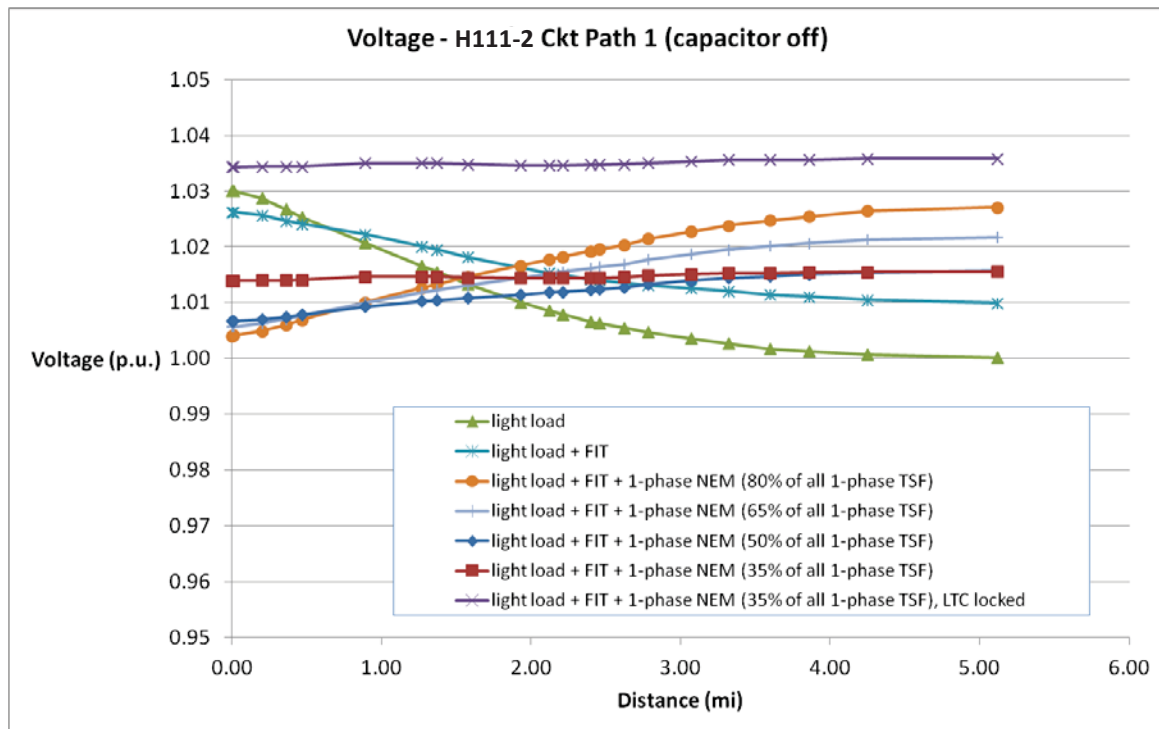

Figure 2-1: Voltage Profile Along H111-2 Circuit Path 1

Therefore, with the reverse mode set as *ignore*, voltage on the feeder could be closer to the nominal value. Further discussion will be given in QSS section.

2.3.4. Loading of Fuses

Figure 2-2 shows the location of fuses on the study feeders. There is one K100 fuse along H111-2 main path 1. The rest of the fuses are on the lateral feeders. The fuses are rated from 5 A to 100 A and are type K fuses.

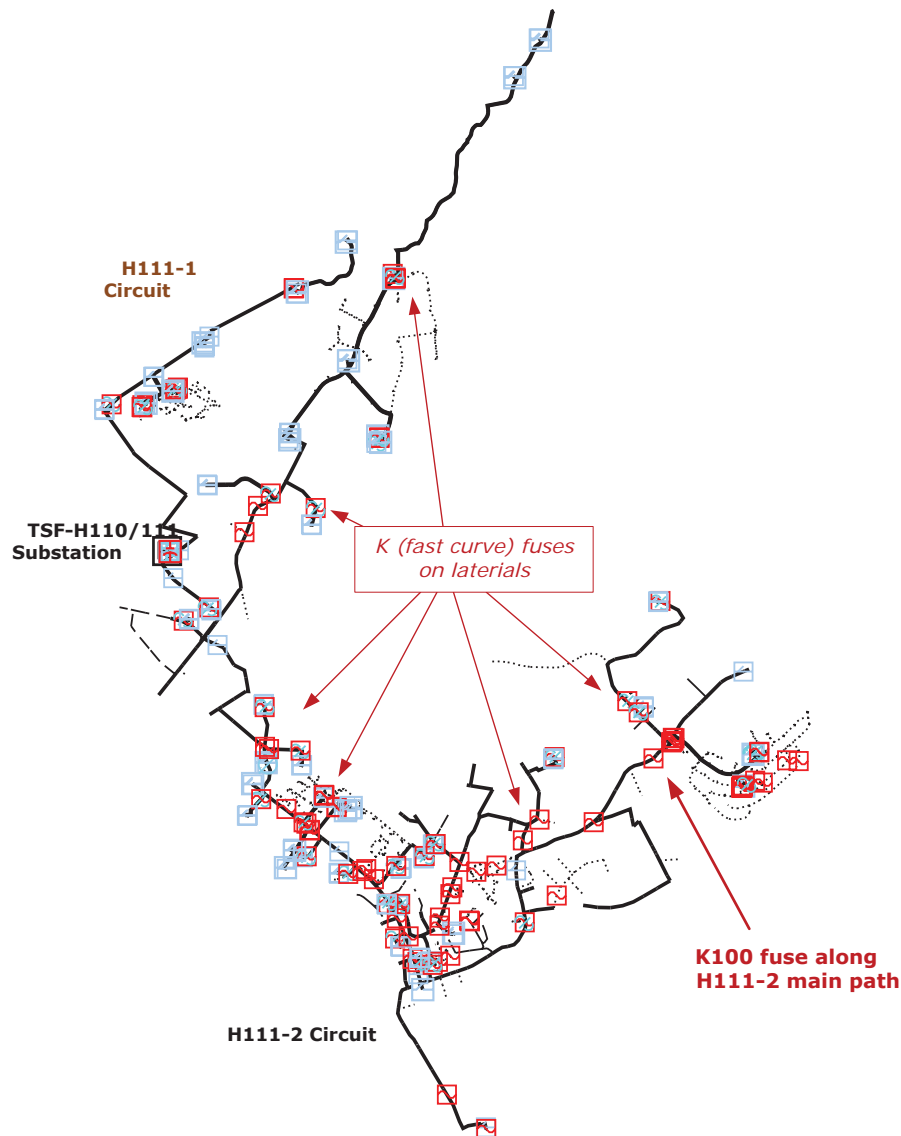

Figure 2-2: Fuses on Study Feeders

Table 2-6 summarizes the thermal loading of these fuses with 9562 kW NEM (Scenario#3) and 4179 kW NEM (Scenario#6) connected on the study feeders. The fuses are not likely to be overloaded during the studied steady

state load flow conditions. The maximum fuse thermal loading with 4179 kW NEM units is 47%.

Table 2-6: Fuse Thermal Loading

Fuse	Fuse Rating (A)	9562 kW NEM				4179 kW NEM			
		IA (A)	IB (A)	IC (A)	Max Loading %	IA (A)	IB (A)	IC (A)	Max Loading %
254862	20	1	1	1	5	1	1	1	5
253675	100	13	13	15	15	13	13	15	15
254763	40	---	2	---	5	---	1	---	3
254766	5	2	---	---	40	1	---	---	20
254770	100	8	7	8	8	8	7	8	8
254849	20	1	1	1	5	1	1	1	5
255753	30	2	2	2	7	2	2	2	7
254529-A	100	12	---	---	12	4	---	---	4
254530-B	100	---	14	---	14	---	5	---	5
254534-C	100	---	---	12	12	---	---	5	5
254532-B	100	---	24	---	24	---	8	---	8
255568	65	3	2	3	5	3	2	3	5
255573	65	4	4	5	8	4	4	5	8
253688-B	100	---	3	---	3	---	1	---	1
253691-A	100	23	---	---	23	8	---	---	8
253694-C	100	---	---	8	8	---	---	4	4
255710-C	100	---	---	19	19	---	---	6	6
255711-B	100	---	20	---	20	---	6	---	6
255417-9982	100	3	3	3	3	3	3	3	3
255420-C	100	0	0	25	25	0	0	8	8
255421-B	100	0	28	0	28	0	9	0	9
51076707	100	3	4	4	4	4	4	4	4
51076708	100	3	4	4	4	4	4	4	4
255810	65	4	4	4	6	4	4	4	6
255365	100	1	1	1	1	1	1	1	1
255393	40	4	4	4	10	4	4	4	10
256198-2923	100	26	25	21	26	8	8	7	8
255957	100	---	---	19	19	---	---	6	6
256209-A	100	26	---	---	26	8	---	---	8
256206-B	100	---	25	---	25	---	9	---	9
256208-C	100	---	---	21	21	---	---	7	7
256021	100	26	---	---	26	8	---	---	8
255933	40	1	0	1	3	1	0	1	3
255934	40	1	0	1	3	1	0	1	3
256061	65	12	11	12	18	12	11	12	18
256127	65	1	1	1	2	1	1	1	2
255907	15	1	1	1	7	1	1	1	7
256098	65	---	14	---	22	---	5	---	8
256055	65	---	17	---	26	---	6	---	9
256313	100	---	20	---	20	---	7	---	7
256101	25	1	1	1	4	1	1	1	4
256360	40	5	5	5	13	5	5	5	13
256086	30	2	2	2	7	2	2	2	7

Fuse	Fuse Rating (A)	9562 kW NEM				4179 kW NEM			
		IA (A)	IB (A)	IC (A)	Max Loading %	IA (A)	IB (A)	IC (A)	Max Loading %
256393	100	7	0	0	7	2	0	0	2
256378	65	12	13	13	20	12	13	13	20
256742	30	1	1	1	3	1	1	1	3
257063	100	10	16	33	33	3	5	10	10
257525	20	1	1	1	5	1	1	1	5
257345	15	10	4	5	67	6	6	7	47
257520	80	---	---	11	14	---	---	4	5
257473	25	1	1	1	4	1	1	1	4
256327	25	1	1	1	4	1	1	1	4
257052	80	---	---	14	18	---	---	4	5
257883	100	8	7	8	8	8	7	8	8
257889	65	8	7	8	12	8	7	8	12
256966	40	---	7	---	18	---	2	---	5
257010	20	---	---	2	10	---	---	1	5
257011	20	---	---	3	15	---	---	1	5
51053327	80	---	---	11	14	---	---	4	5
256655	80	9	9	9	11	13	11	12	16
256676	30	2	1	1	7	1	1	1	3
256723	100	---	12	---	12	---	4	---	4
51070464-9166	25	1	1	1	4	1	1	1	4
257129	15	1	1	1	7	1	1	1	7
257132	25	---	---	5	20	---	---	1	4
257134	25	---	---	6	24	---	---	2	8
257119	50	1	1	0	2	0	0	0	0
51083878	100	4	3	2	4	2	1	2	2
258642	5	---	---	2	40	---	---	1	20
256717	100	---	27	---	27	---	9	---	9
258530	65	4	4	4	6	4	4	4	6
258491	100	61	83	74	83	19	27	23	27
51114794-3477	100	8	40	20	40	2	13	6	13
51114788-3476	100	1	25	32	32	1	8	10	10
261064	100	14	---	---	14	4	---	---	4
261062	100	---	---	14	14	---	---	4	4
261063	100	---	8	---	8	---	3	---	3
261213-B	65	---	37	---	57	---	13	---	20
261204	100	---	32	---	32	---	11	---	11
261212-C	65	---	---	6	9	---	---	2	3
258484	10	1	---	1	10	0	---	0	0
261210-B	65	---	3	---	5	---	1	---	2
261211-C	65	---	---	15	23	---	---	5	8
261209-A	65	8	---	---	12	3	---	---	5
261208-B	65	---	26	---	40	---	9	---	14
261205-8549	100	---	---	6	6	---	---	2	2

Fuse	Fuse Rating (A)	9562 kW NEM				4179 kW NEM			
		IA (A)	IB (A)	IC (A)	Max Loading %	IA (A)	IB (A)	IC (A)	Max Loading %
261219-C	65	---	---	32	49	---	---	10	15
262745-8550	100	---	---	0	0	---	---	0	0
262747-8551	100	---	0	---	0	---	0	---	0
258357	20	5	---	---	25	1	---	---	5
260832	25	1	1	1	4	1	1	1	4
Max Loading					83				47

2.4. Conclusions

The following conclusions are made from the steady state load flow analysis:

- There is no existing problem on the H111-2 and H111-1 distribution feeders.
- The maximum penetration level for single-phase NEM units is found to be 4179 kW on the study feeders:
 - a. A total of 4179 kW of single-phase NEM units could be added to the study feeders without causing violations regarding voltage regulation, thermal loading of substation transformer or feeder conductors, voltage imbalance level or sensitivity of ground protection.
 - b. The LTC/LDC controller setting should be set as “ignore” for reverse power flow
 - c. This penetration level and reverse power mode is based on steady state load flow only. This level has to be further checked with quasi-steady state analysis.
 - d. The existing fuses are able to withstand the increased thermal flow due to the addition of the NEM units.

Section 3. Quasi-Steady-State (QSS) Analysis

Results discussed in Section 2 were based on single power flow with nominal output power of PV units. In this section, Quasi Steady State (QSS) analysis is conducted with OpenDSS software to illustrate impending effects of variable load/irradiation profile. It is assumed that, power injected at each node is linearly proportional with connected kVA of single-phase transformers.

3.1. Modeling Procedure:

In order to perform QSS analysis, the SynerGEE model provided by Hawaiian Electric is transferred to OpenDSS. For reducing the number of injection points, H111-2 and H111-1 feeders are divided to several zones (as a rule of thumb, every 0.5 mile of main branch's conductor is considered as a single zone). For each zone, single-phase PV units (including the units connected to lateral branches) are lumped to three single-phase generators connected to the main branch in middle of the zone. Rated power of each generator is linearly proportional with single-phase kVA connected to the phase of interest inside the zone. The same approach is used for loads and FIT units. Figure 3-1 and Figure 3-2 demonstrate this procedure.

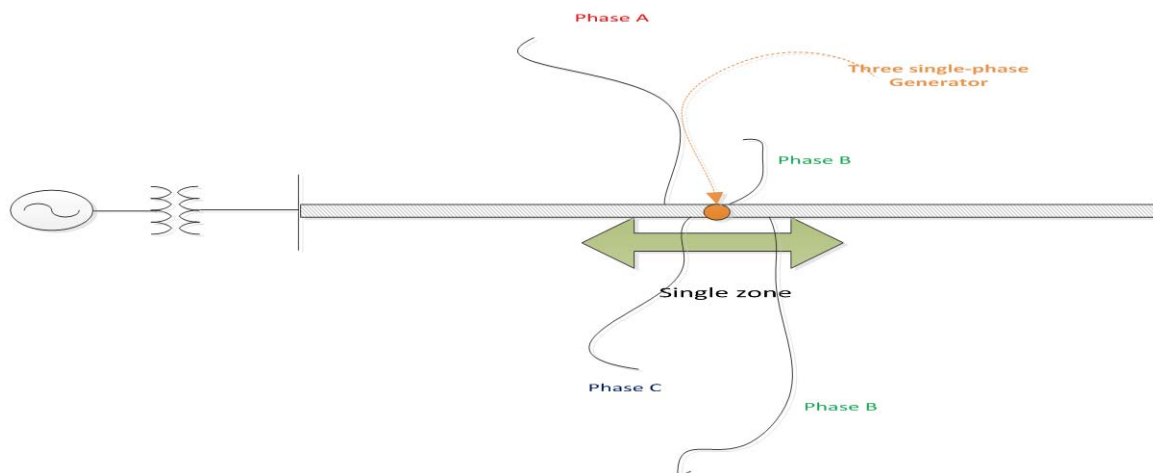

Figure 3-1: Single Phase Generators on Lateral Branches are Lumped as Three Single-Phase Generator at the Main Branch For QSS Analysis



Figure 3-2: Demonstration of QSS Simplification of H111-2 Circuit

Following the aforementioned procedure, twenty zones are developed for H111-2 and H111-1 Circuits. Six voltage monitors are placed along H111-2 and H111-1 Circuits. Figure 3-3 shows considered zones (black dashed lines) as well as monitors (green circles). Table 3-1 summarizes load and connected single phase kVA for each zones.

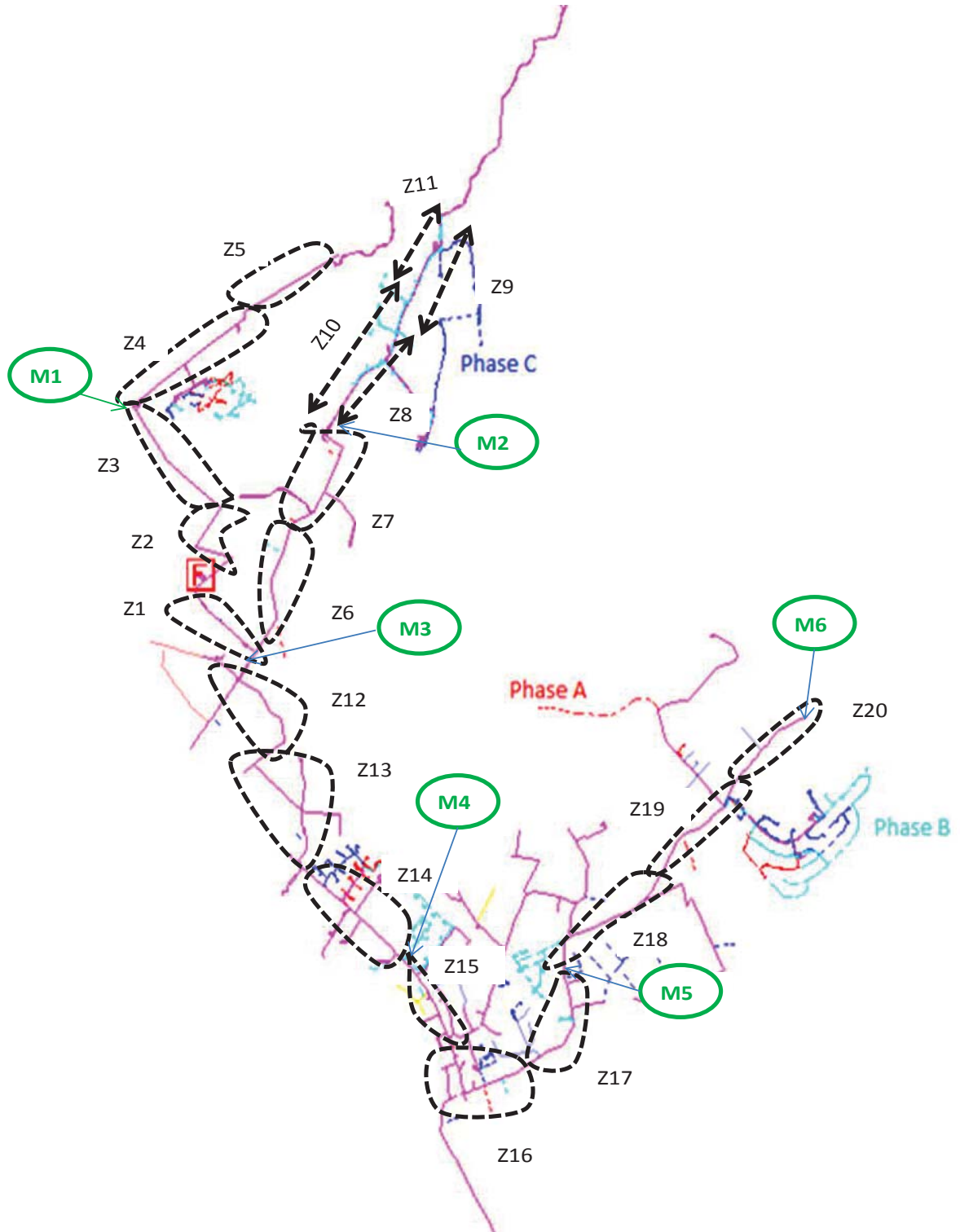

Figure 3-3: Considered Zones (Z) and Monitors (M)

Table 3-1: Distributed Load and Single-Phase Connected KVA for Considered Zones

Zones	Distributed Load						Connected Single phase KVA		
	KW			KVAR					
	A	B	C	A	B	C	A	B	C
Z1	8	6	11	4	4	6	25	25	50
Z2			10			5	0	0	25
Z3	112	98	130	57	50	20	25	0	25
Z4	291	305	258	152	155	130	512.5	600	312.5
Z5	43	41	50	22	21	25	0	0	0
Z6	62	54	50	32	30	28	60	65	0
Z7	33	24	27	17	14	15	37.5	0	0
Z8	26	50	59	13	30	31	0	212.5	212.5
Z9	0	0	0	0	0	0	0	0	0
Z10	0	0	0	0	0	0	0	0	0
Z11	39	75	82	20	44	43	0	300	275
Z12	32	19	12	13	16	6	180	205	37.5
Z13	44	26	31	22	15	17	65	0	10
Z14	217	158	191	110	91	103	612.5	400	475
Z15	206	264	217	109	151	114	356.25	1066.25	528.75
Z16	145	84	86	74	48	47	500	202.5	150
Z17	42	13	72	32	8	27	225	75	512.5
Z18	146	179	153	74	109	81	207.5	672.5	280
Z19	120	125	139	65	74	66	687.5	875	862.5
Z20	9	5	6	6	3	1.8	50	37.5	50

3.2. Simulation Result for a Typical Sunny Day

Steady states analysis conducted in Section 2 demonstrated a voltage imbalance violation for injection equal to 80% of single phase transformers plus 100% of FIT units. Starting from this penetration level and using a smooth irradiation curve as shown in Figure 3-4, ten daily scenarios are simulated as in Table 3-2. In simulated scenarios, FIT units are assumed to output their nominal power but total single phase injected power is decreased as scenario number increases (single phase injection is inversely proportional with scenario number). Simulation results are tabulated in Table 3-2.

Daily simulations suggest that voltage imbalance may violate NEMA MG1-1993 threshold of 1% if total penetration (including FIT) exceeds 6.6 MW. Therefore, NEM penetration level obtained in Section 2, Scenario #6, 4179 kW, needs to be further reduced to about 3223 kW (look at Scenario #3 in

Table 3-2). Figure 3-5 through Figure 3-10 show daily voltage profile at considered monitors for Scenario#3 (6.6 MW of injection).

In Section 3.3, cloud movement simulation is conducted for Scenario#3 to show impending effects of variable irradiation on power quality indices.

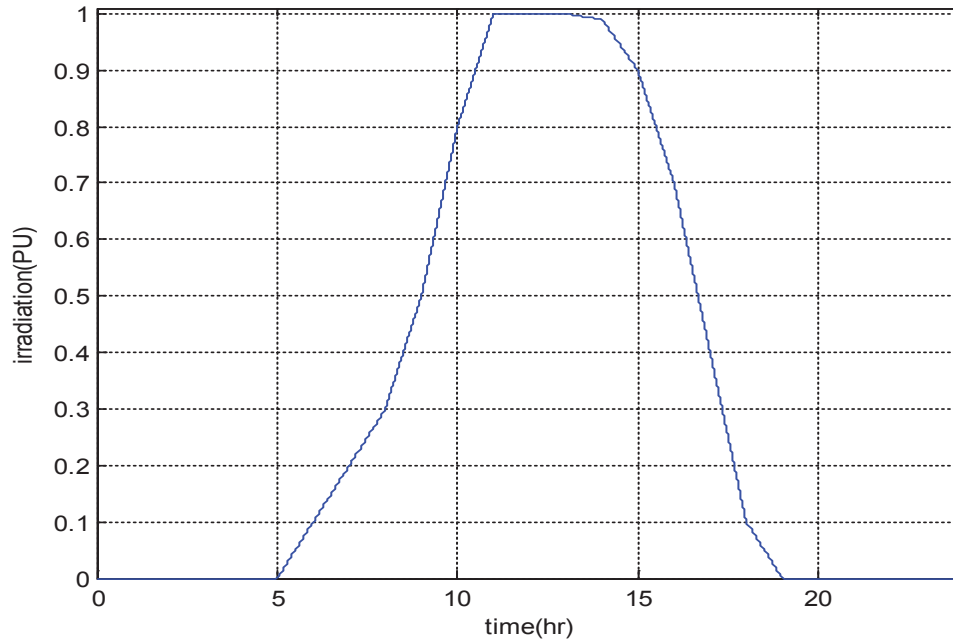

Figure 3-4: Assumed Irradiation for a Typical Sunny Day

Table 3-2: Summary of Daily simulation for a Sunny Day

Scenario#	FIT Injection(KW)	Single Phase Injection(KW)	Total Injection	Max Voltage Imbalance (%)	Max ¹ Ig/Ip for TSF-H111 (%)	Max Ig/Ip for Rec 60 (%)	Number of tap Movement
1	3350	9669	13019	2.46	38.7	27.3	8
2	3350	4835	8185	1.31	18.7	13.5	6
3	3350	3223	6573	0.96	12.7	9.5	6
4	3350	2417	5767	0.80	9.8	7.5	4
5	3350	1934	5284	0.70	8.2	6.4	4
6	3350	1612	4962	0.63	7.0	5.6	4
7	3350	1381	4731	0.59	6.3	5.1	4
8	3350	1209	4559	0.55	5.8	4.7	4
9	3350	1074	4424	0.52	5	4.4	4
10	3350	967	4317	0.50	5.2	4.1	4

1) I_g is $3I_0$ and I_p is the pickup setting of ground relay.

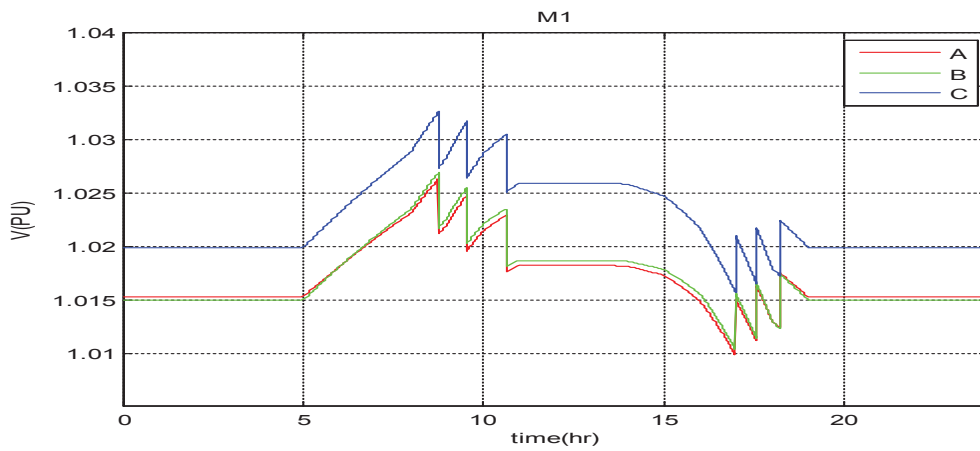

Figure 3-5: Daily Simulation Result at Monitor1 - Scenario#3

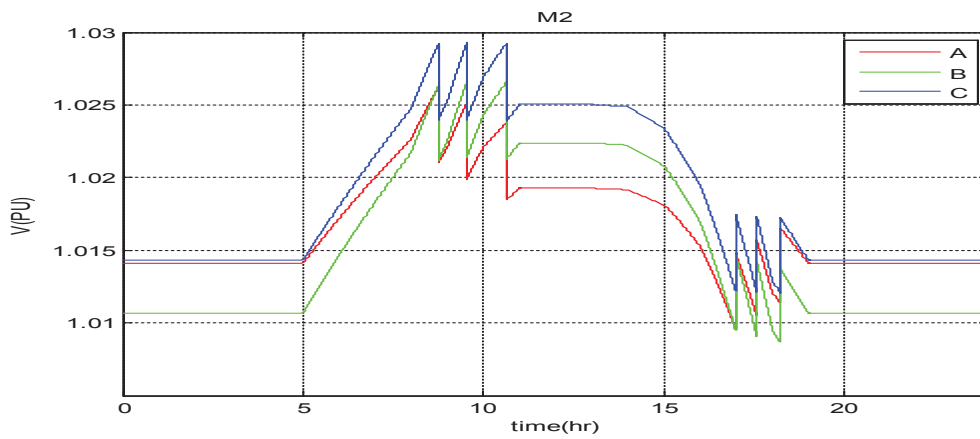

Figure 3-6: Daily Simulation Result at Monitor2 - Scenario#3

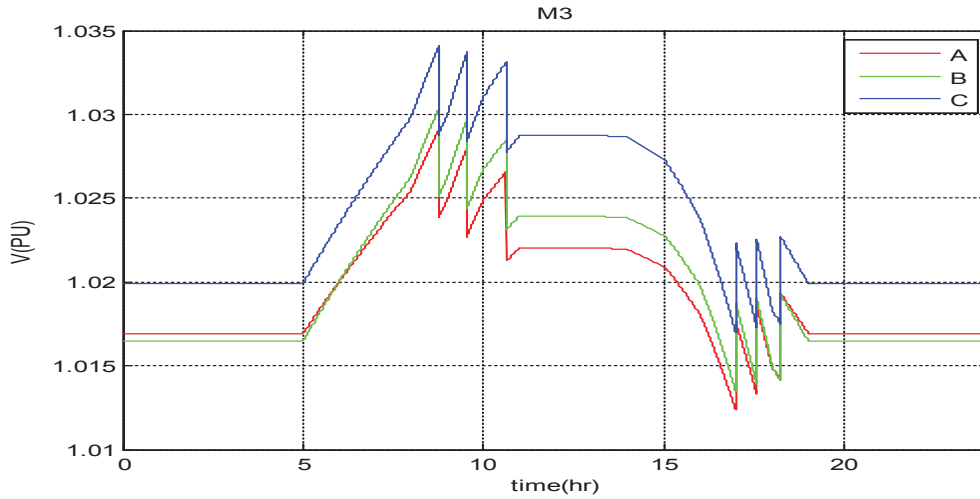

Figure 3-7: Daily Simulation Result at Monitor3 - Scenario#3

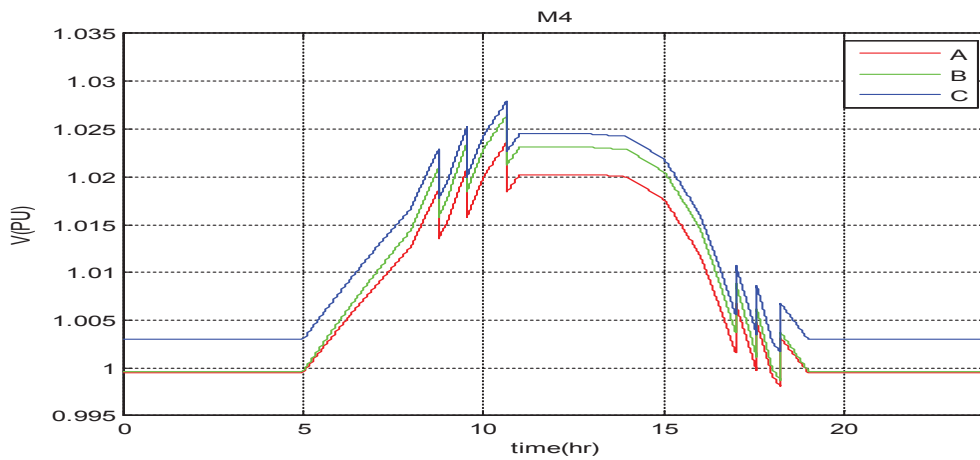

Figure 3-8: Daily Simulation Result at Monitor4 - Scenario#3

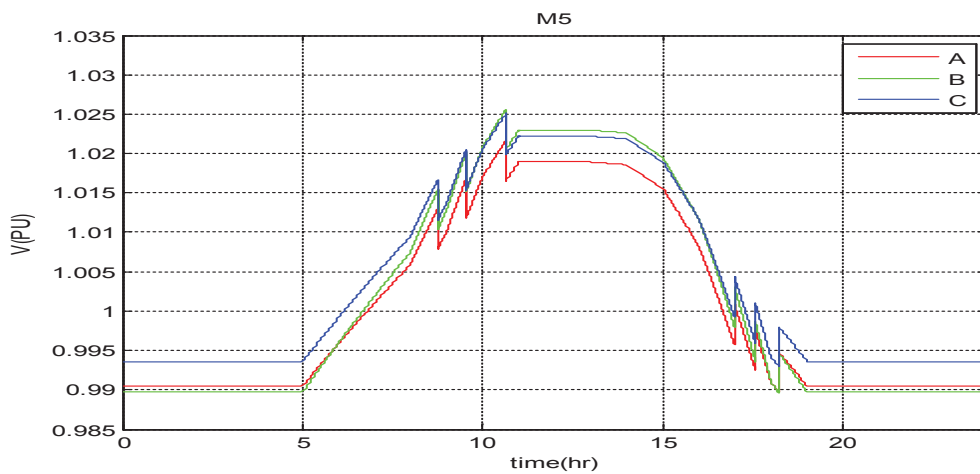

Figure 3-9: Daily Simulation Result at Monitor5 - Scenario#3

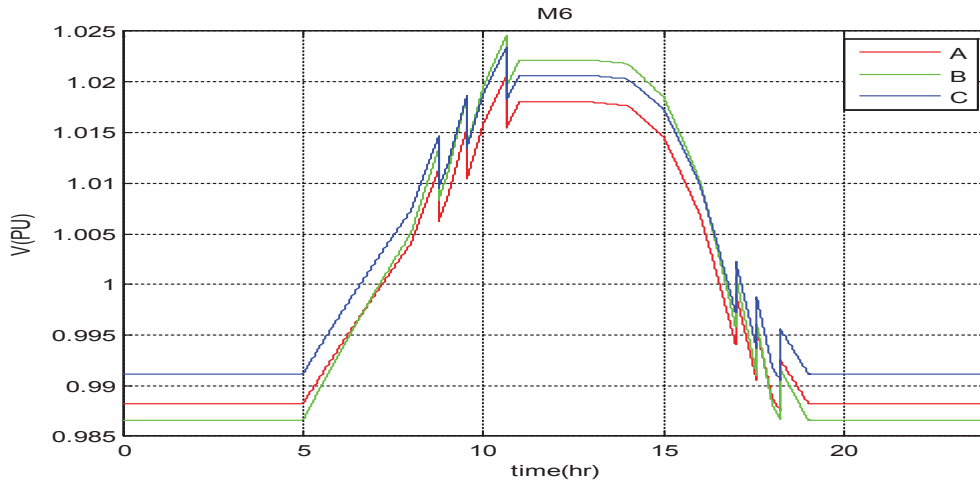
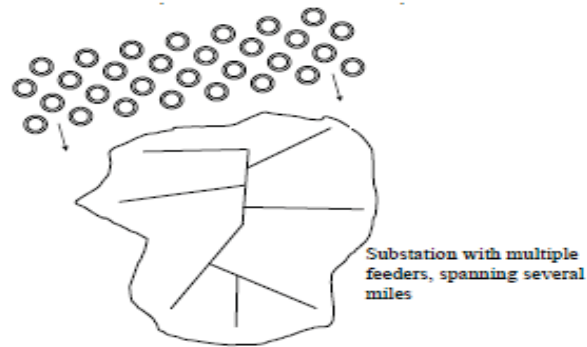

Figure 3-10: Daily Simulation Result at Monitor6 - Scenario#3

3.3. Cloud Movement Simulation:

Cloud movement can negatively impact power quality indices (i.e. voltage imbalance, current imbalance, etc.) on distribution feeders with high PV penetration. Cloud shadow models may be used to simulate impending effects of cloud movements. Grady *et al*⁶. suggested a cloud shadow movement model suitable for distribution system studies as depicted in Figure 3-11. Adopting this model, power generated by a single PV unit varies as shown in Figure 3-12.

⁶ W. M.Grady, L. Libby, A Cloud Shadow Model and Tracker Suitable for Studying the Impact of High-Penetration on Power Systems, IEEE Energytech 2012, pp.1-6, May 2012



- A repeating pattern. The circles represent moving shadows due to clouds.
- When no shadow, use panel clear sky P_{max} for the given time of day and panel orientation.
- When inside a 50-second diameter (see A), use $P_{max} / 3$.
- When inside a 5-second circular transition ring (see C – A), assume linear variation between P_{max} and $P_{max} / 3$.

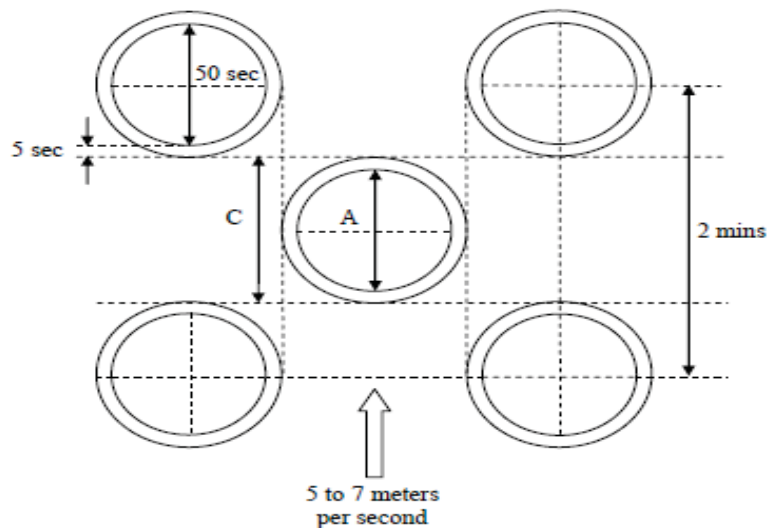

Figure 3-11: Cloud Shadow Model Suggested by Grady et al⁷

⁷ W. M. Grady, L. Libby, A Cloud Shadow Model and Tracker Suitable for Studying the Impact of High-Penetration on Power Systems, IEEE Energytech 2012, pp.1-6, May 2012

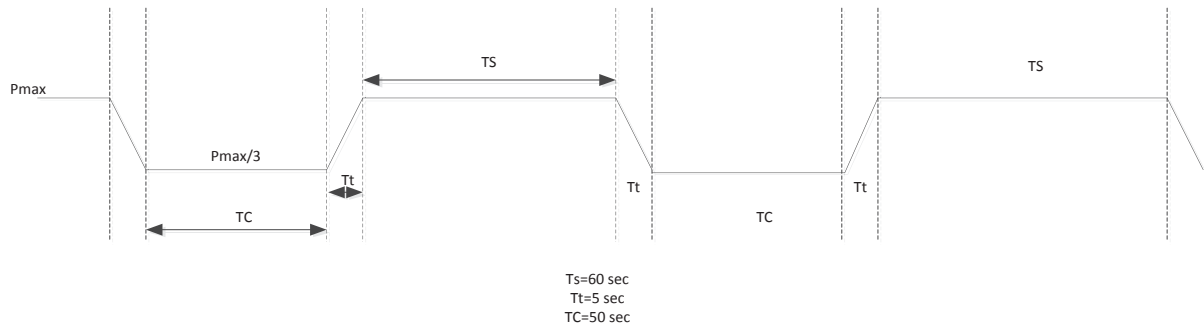

Figure 3-12: Generation Pattern as Cloud Moves

H111-2 feeder's geographical footprint, shown in Figure 3-13, is about 4.5 miles vertical and 3.2 miles horizontal. In order to simulate cloud movement, feeder's geographical footprint is divided to geographical zones (as a rule of thumb, every 0.5 mile by 0.5 mile is considered as a single geographical zone). The same irradiation pattern is assumed for all PV units located in the same zone. Dashed lines in Figure 3-13 illustrate assumed geographical zones.

Using typical shadow speed (5 m/s ~ 7 m/s), cloud movement simulation is conducted for scenario#3 where cloud shadow sweeps the feeder on four main directions (i.e. N-S, S-N, W-E, E-W). In order to capture the maximum impending effects of a given PV penetration, it is assumed that shadow movement occurs during noon-time (i.e. between 11 am and 1 pm) when all units output their nominal power.

Figure 3-14 through Figure 3-19 and Figure 3-20 through Figure 3-25 show voltage profile at monitors for Scenario#3 (injection of 6.573 MW) where shadow moves with 7 m/s from south to north and west to east, respectively.

Table 3-3 summarizes cloud movement simulation results for scenario#3 with shadow speed of 5 m/s and 7 m/s where LTC is set to ignore reverse power flow. Note that shadow speed doesn't change power quality indices significantly but it can impact the number of tap movement. However, continuous shadow movement scenario occurs rarely if at all. In addition, the H111-2 Circuit does not have a big footprint. Therefore, in evaluating tap movements, using the same irradiation pattern for the whole of the feeder seems sufficient.

From a tap cycling point of view, it is not recommended to lock the LTC (at neutral) during reverse power flow. Table 3-4 summarizes simulation results for a sunny day (irradiation of Figure 3-4) with two LTC reverse power flow settings: 1) ignore and 2) lock at neutral. Although 'lock setting' eliminates impending tap movement during reverse power flow (e.g. between 10 am and 4 pm), the increment of tap movement when power direction switches back to forward is such that total daily tap movement is increased compared

to the ignore setting. Figure 3-26 shows tap position for ignore and lock settings. Tap cycling with LTC lock setting can become more severe when shadow sweeps the feeder. Table 3-5 summarizes simulation results for cloud movement with LTC lock setting. Yearly tap cycling analysis will be conducted in the next section.

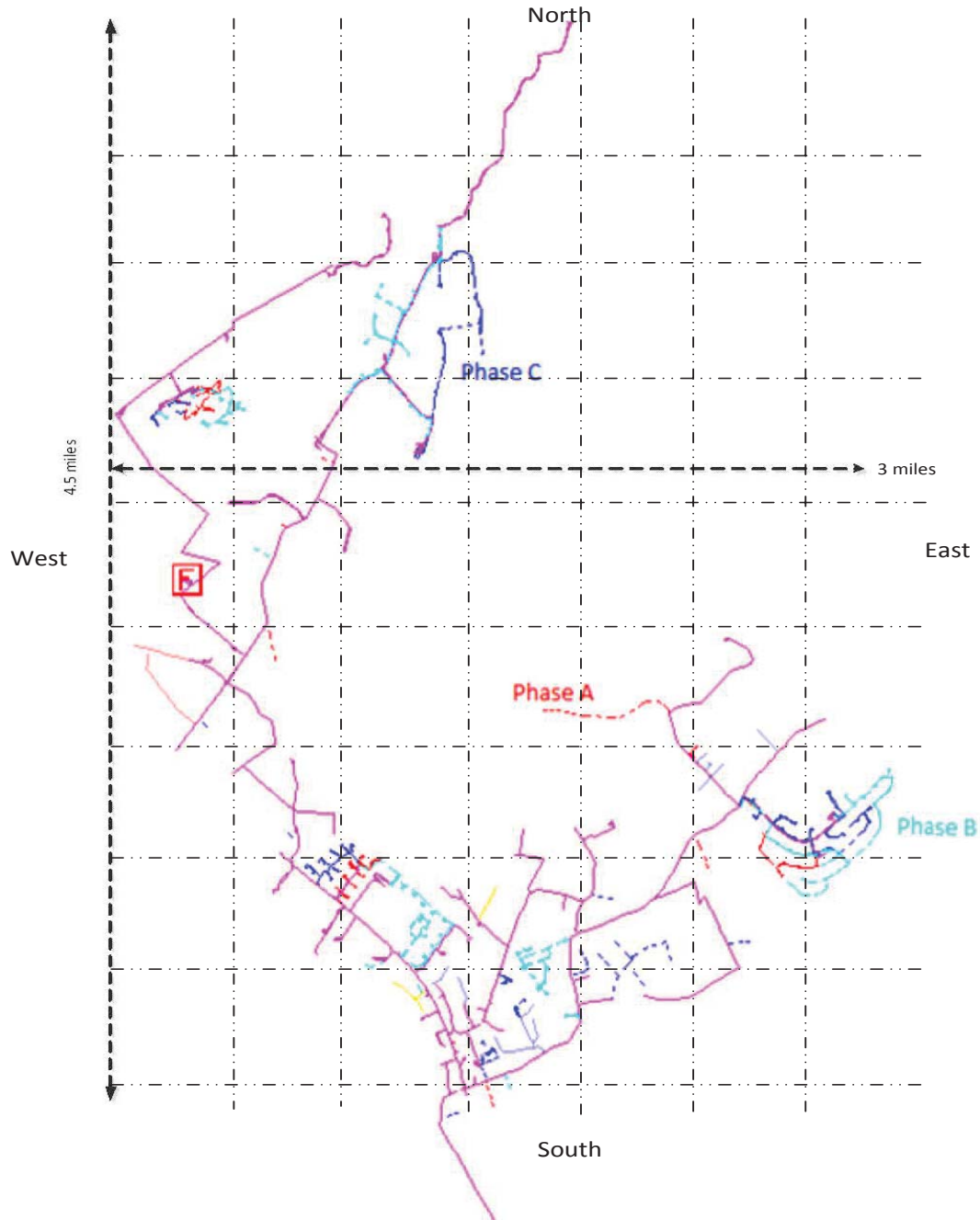

Figure 3-13: H111-2 Circuit and Considered Geographical Zones

Table 3-3: Summary of Daily Simulation for Shadow Movement (Scenario#3) - Ignore Setting for LTC Reverse Power Flow

Shadow Direction	shadow speed=5m/s				shadow speed=7m/s			
	Max Voltage Imbalance (%)	Max Ig/lp for TSF-H111	Max Ig/lp for Rec 60	Number of tap Movement	Max Voltage Imbalance (%)	Max Ig/lp for TSF-H111(%)	Max Ig/lp for Rec 60(%)	Number of tap Movement
North to South	0.97	12.72	9.77	6	0.97	12.72	9.78	6
South to North	0.97	12.72	9.53	6	0.97	12.72	9.78	118
West to East	1.08	12.9	11.07	6	1.08	12.9	11.7	6
East to West	1.08	12.9	11.7	6	1.08	12.9	11.7	6

Table 3-4: Comparison Between 'Ignore' and 'Locked at Neutral' Setting - Sunny Day Scenario#3

LTC reverse power setting	Max Voltage Imbalance (%)	Max Ig/lp for TSF-H111(%)	Max Ig/lp for Rec 60(%)	Number of tap Movement
Ignore	0.97	12.72	9.53	6
Lock at neutral	0.97	12.90	9.60	12

Table 3-5: Summary of Daily Simulation for Shadow Movement (Scenario#3) - Lock at Neutral Setting for LTC Reverse Power Flow

Shadow Direction	shadow speed = 5 m/s				shadow speed = 7 m/s			
	Max Voltage Imbalance (%)	Max Ig/lp for TSF-H111	Max Ig/lp for Rec 60	Number of tap Movement	Max Voltage Imbalance (%)	Max Ig/lp for TSF-H111(%)	Max Ig/lp for Rec 60(%)	Number of tap Movement
North to South	0.97	12.90	9.89	236	0.97	12.90	9.90	364
South to North	0.97	12.90	9.64	248	0.97	12.90	9.80	358
West to East	1.08	13.13	11.84	234	1.08	13.13	11.85	350
East to West	1.08	13.14	11.85	230	1.08	13.06	11.80	344

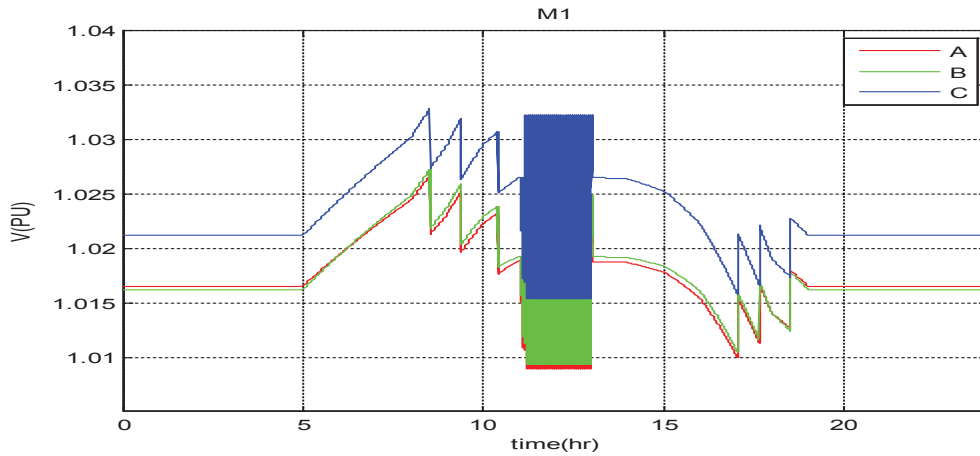

Figure 3-14: Voltage Profile at M1 - Shadow Moves from South to North

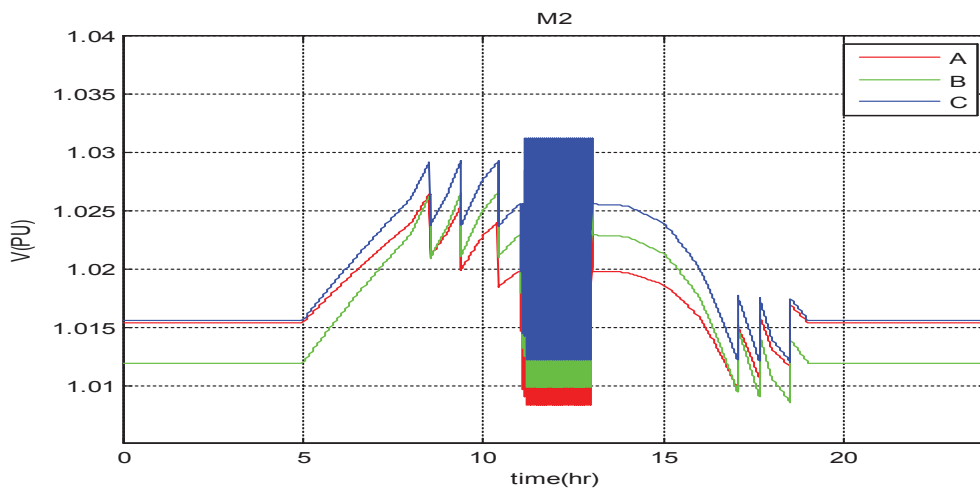

Figure 3-15: Voltage Profile at M2 - Shadow Moves from South to North

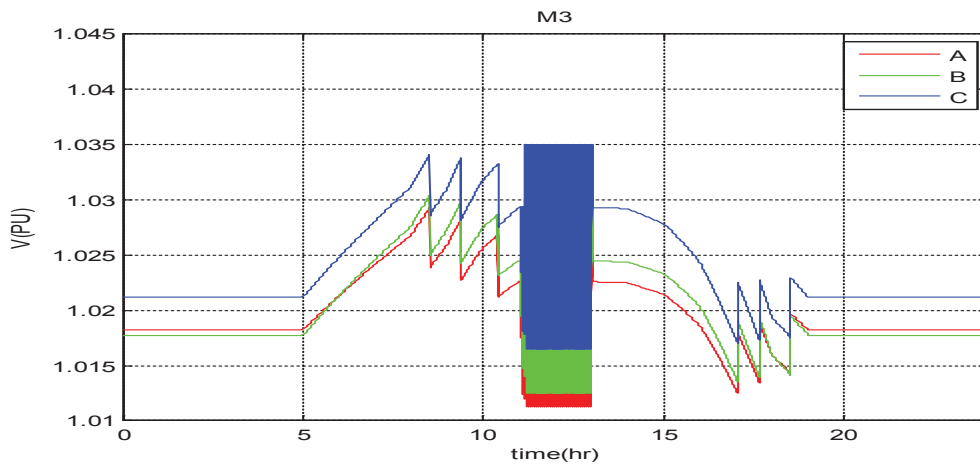

Figure 3-16: Voltage Profile at M3 - Shadow Moves from South to North

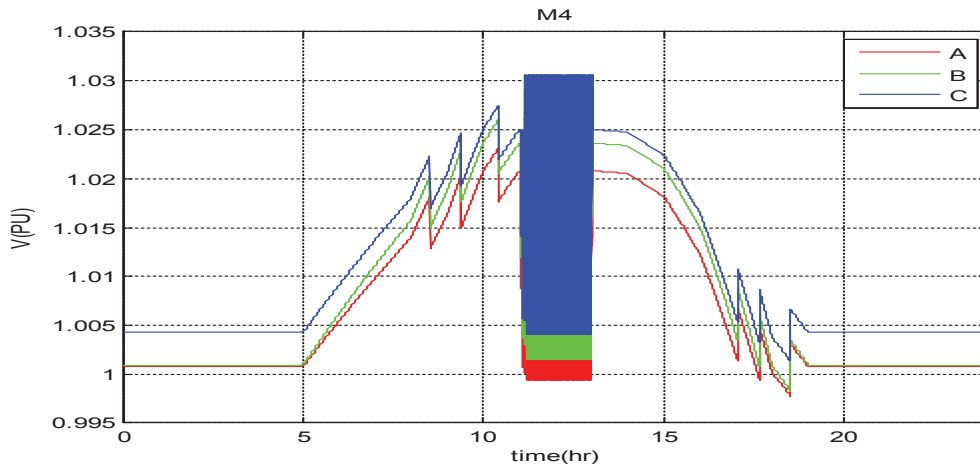

Figure 3-17: Voltage Profile at M4 - Shadow Moves from South to North

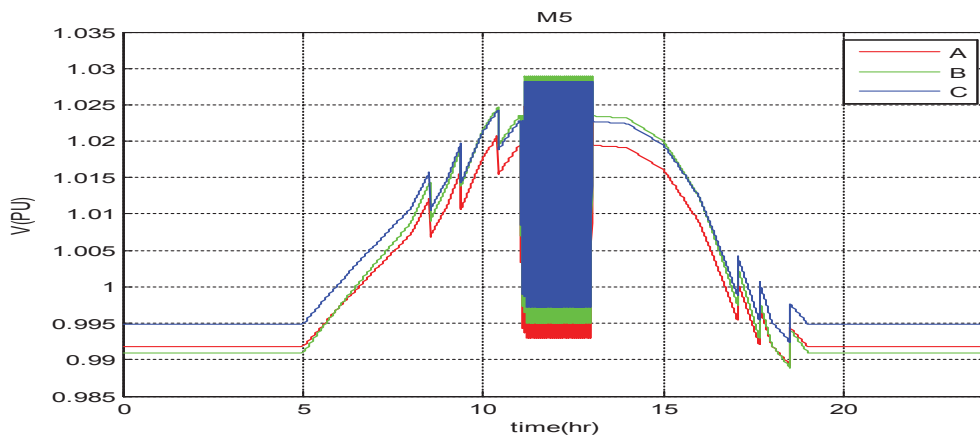

Figure 3-18: Voltage Profile at M5 - Shadow Moves from South to North

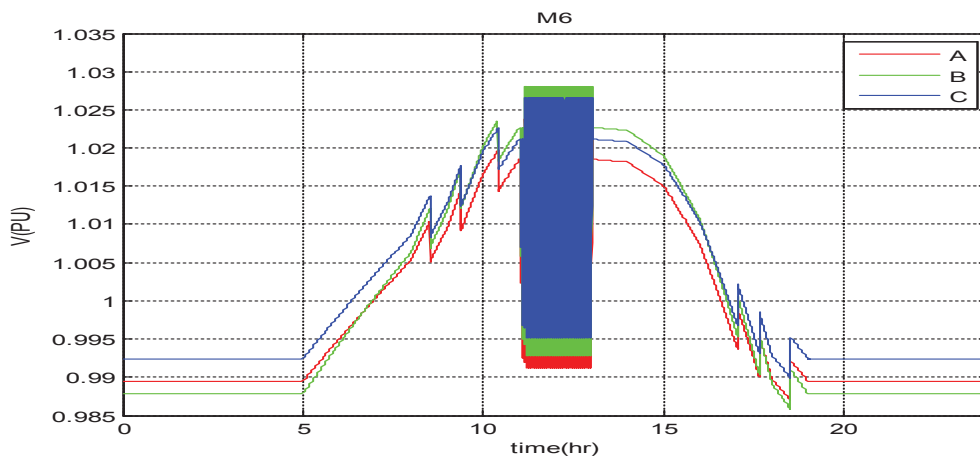

Figure 3-19: Voltage Profile at M6 - Shadow Moves from South to North

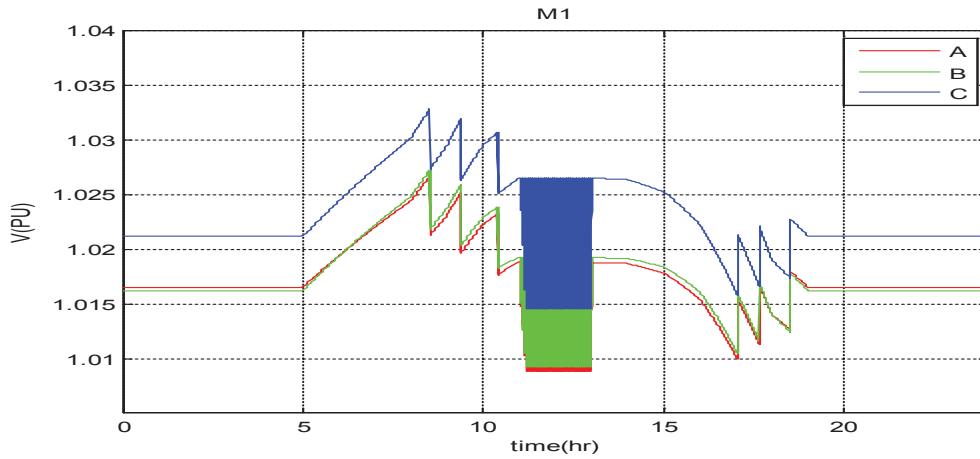

Figure 3-20: Voltage Profile at M1 - Shadow Moves from West to East

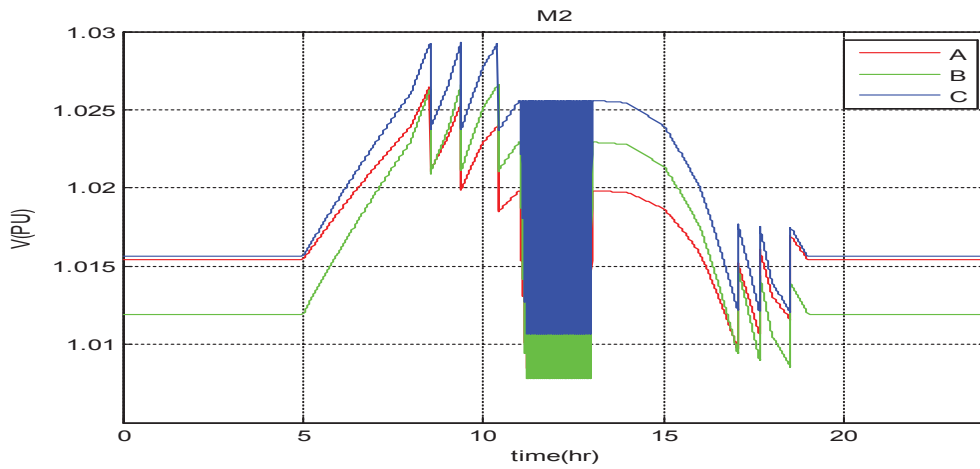

Figure 3-21: Voltage Profile at M2 - Shadow Moves from West to East

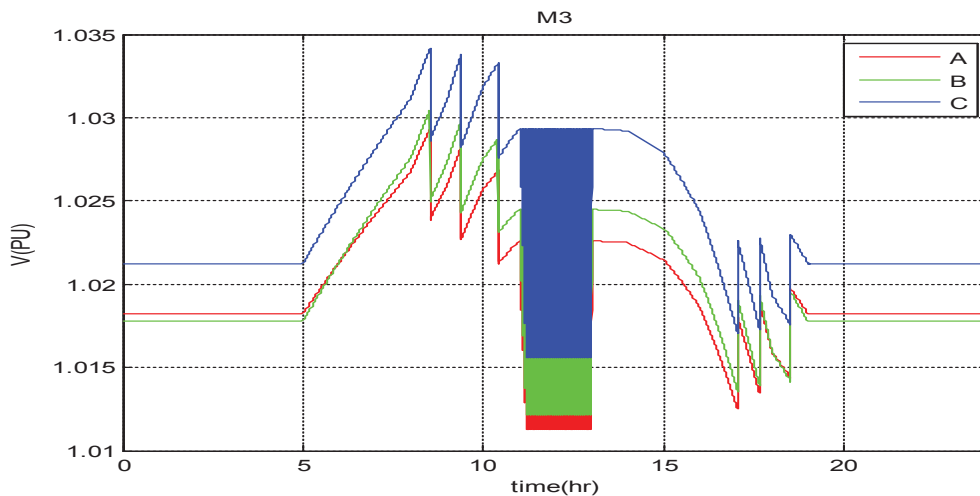

Figure 3-22: Voltage Profile at M3 - Shadow Moves from West to East

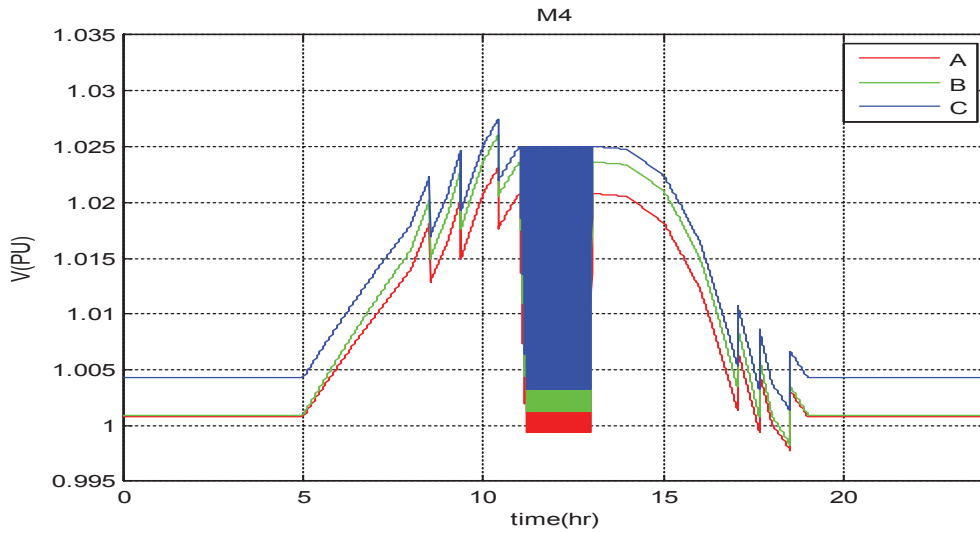

Figure 3-23: Voltage Profile at M4 - Shadow Moves from West to East

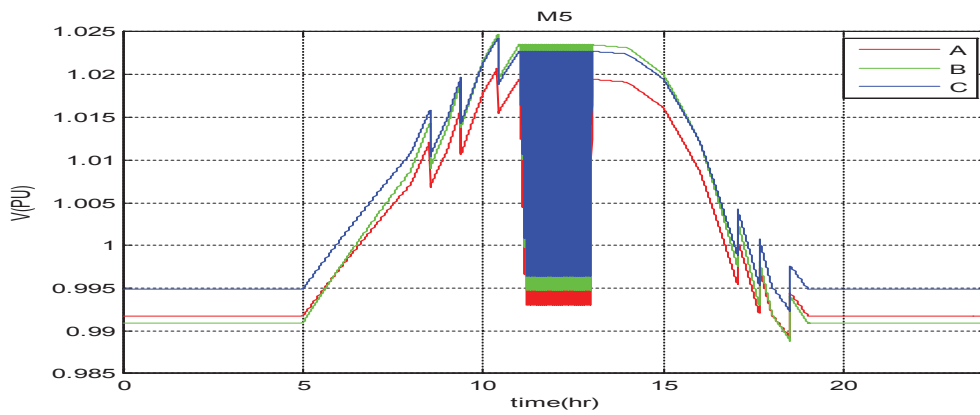

Figure 3-24: Voltage Profile at M5 - Shadow Moves from West to East

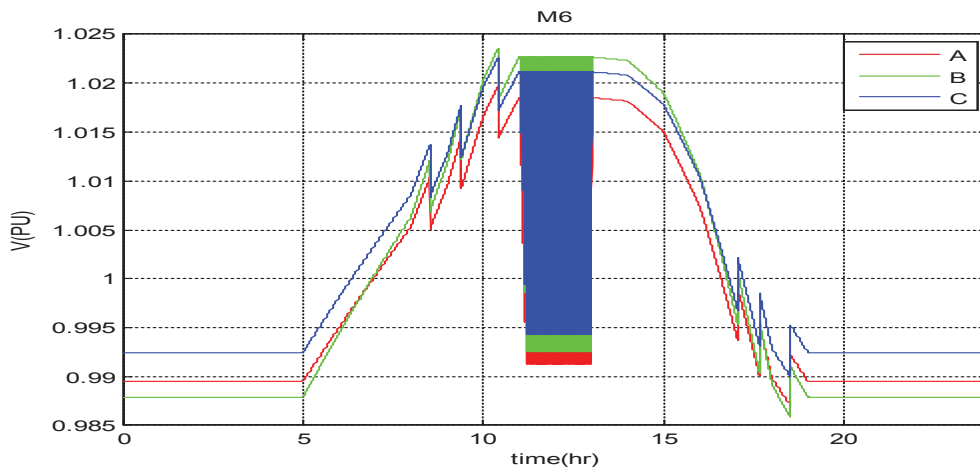

Figure 3-25: Voltage Profile at M6 - Shadow Moves from West to East

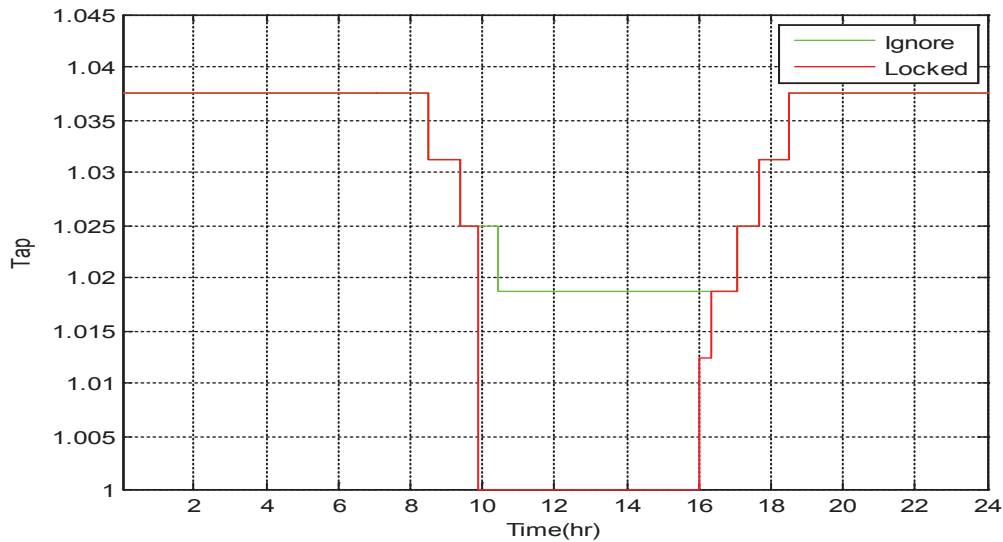

Figure 3-26: Tap Position for Considered Sunny Day with LTC Reverse Power Flow Setting of 'ignore' and 'lock at neutral'

3.4. Yearly Tap Cycling

Tap cycling can be a concern for distribution circuits with high PV penetration. Simulation results presented in previous sections were using a flat load profile and semi-sunny irradiation profile of Figure 3-4. Load and irradiation profile play an important role in tap cycling analysis. Therefore, using measured load and irradiation data, simulation results can mimic feeder's tap cycling behavior more closely. In this section, measured yearly load and irradiation data are used in yearly QSS analysis in order to demonstrate Project's contribution (i.e. contribution of 3223 kW single-phase NEM) from tap cycling point of view.

Hawaiian Electric provided load data of H111-2 and H111-1 Circuits for the time period of January 2008 to January 2011 (load profile pre-PV). In order to do yearly tap cycling analysis, one year of load data needs to be selected. National Renewable Energy Laboratory (NREL) irradiation data from March 2010 to October 2011 at Oahu site (approximately 20 miles away from the study feeders), is publicly available. Since the provided load and irradiation don't coincide for a full year, the latest full year irradiation data (Nov 2010 ~ Oct 2011) is used along with the load that was measured at the same time of previous year (Nov 2009 ~ Oct 2010). Figure 3-27 and Figure 3-28 show the loading of H111-2 and H111-1 in selected time span as provided by Hawaiian Electric. Red circles in these figures show suspicious noisy points where load suddenly jump to a very low/high value. Load threshold of 2 and 0.1 MW (green dashed line) are considered as load lower limit for H111-2 and H111-1 Circuits, respectively.

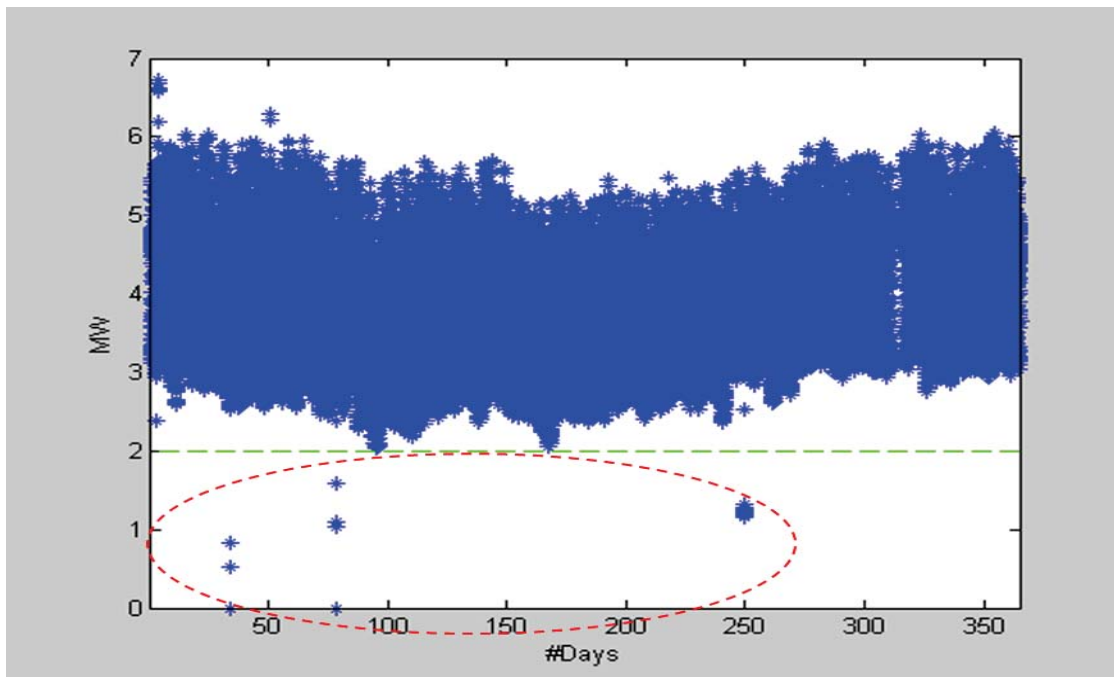

Figure 3-27: H111-2 Circuit Load as Provided by Hawaiian Electric

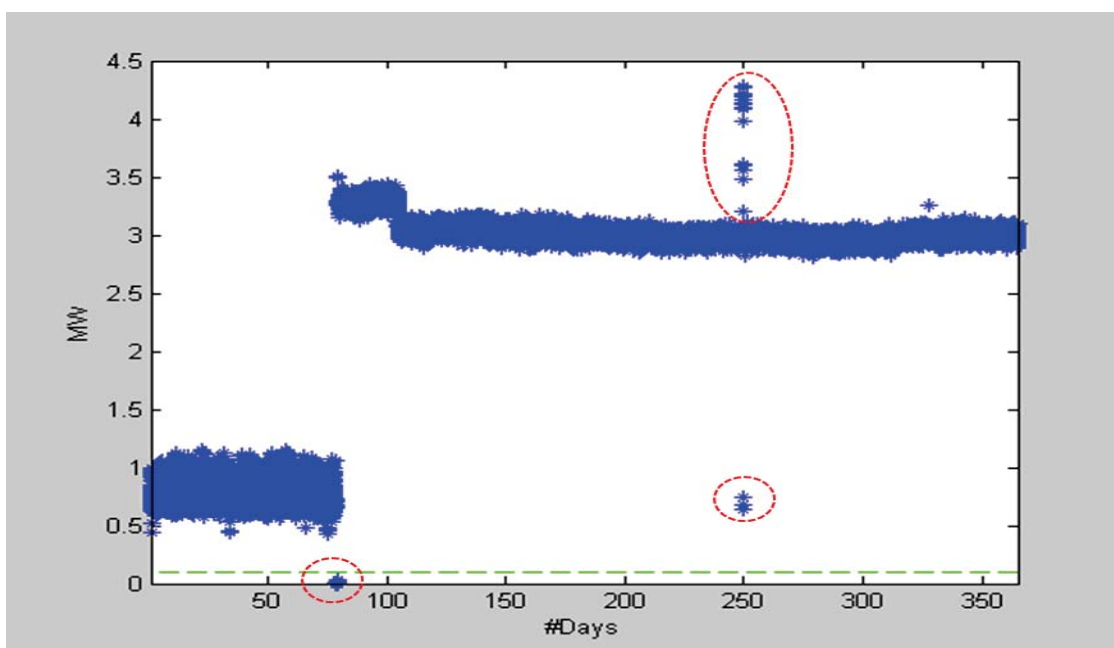

Figure 3-28: H111-1 Circuit Load as Provided by Hawaiian Electric

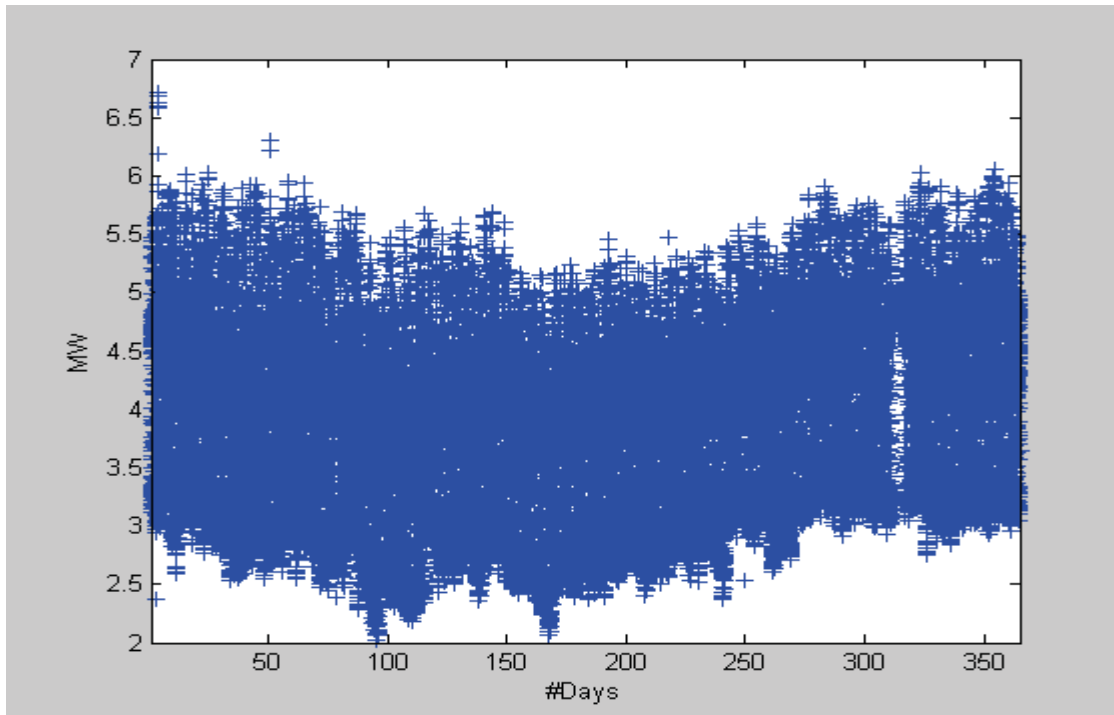

Figure 3-29: H111-2 Circuit Filtered Load

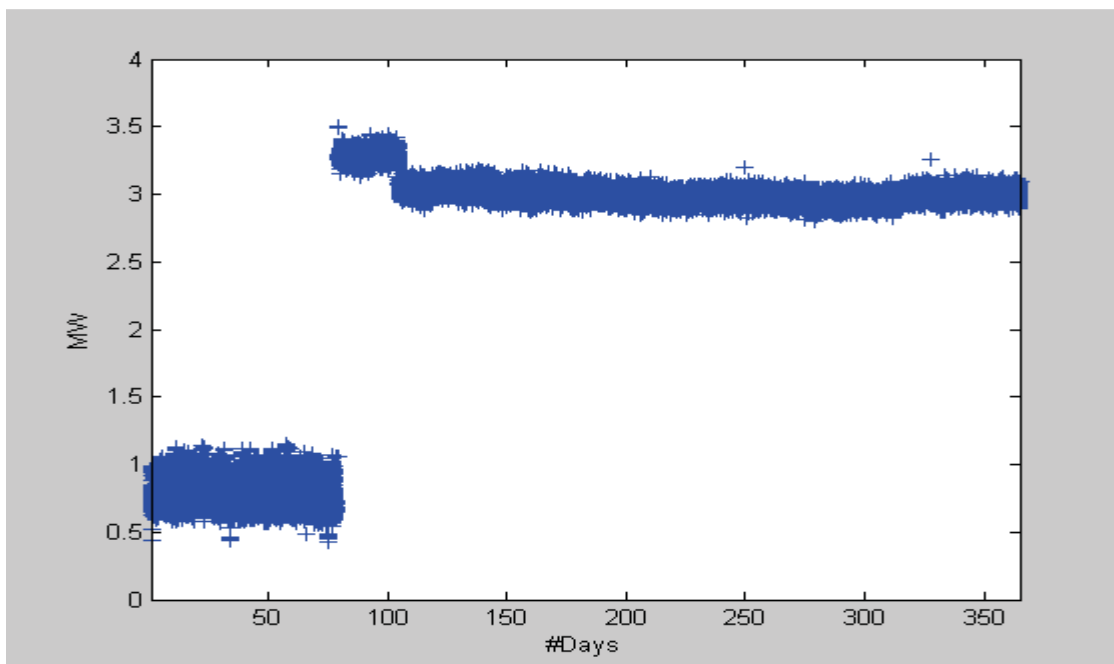

Figure 3-30: H111-1 Circuit Filtered Load

Load blip on H111-1 is also ignored. Figure 3-29 and Figure 3-30 show filtered load profiles in H111-2 and H111-1, respectively. On irradiation side, NREL raw data files include the output of nineteen sensors measuring irradiation at different locations of Oahu vicinity. In our analysis, average of nineteen sensors outputs is used for the whole of the feeder.

Figure 3-31 through Figure 3-33 demonstrate Project's monthly and yearly contribution (i.e. contribution of 3223 kW single-phase NEM) from tap cycling point of view. Blue and red bars represent number of tap movements without and with the NEM units, respectively. Since Project is considered as single phase NEM units, both of blue and red bars of figures include tap cycling contribution of three-phase FIT units.

Considering Figure 3-33, incremental tap cycling contribution of about 185% is expected for 3223 kW single-phase NEM. Figure 3-33 through Figure 3-44 show Project's daily tap cycling contribution for all of simulated days.

Maximum daily contribution of the Project occurs on Jun 28th where tap movement increases from 20 to about 112. Irradiation pattern of this day, shown in Figure 3-43, shows many fluctuations with considerable dips/swells.

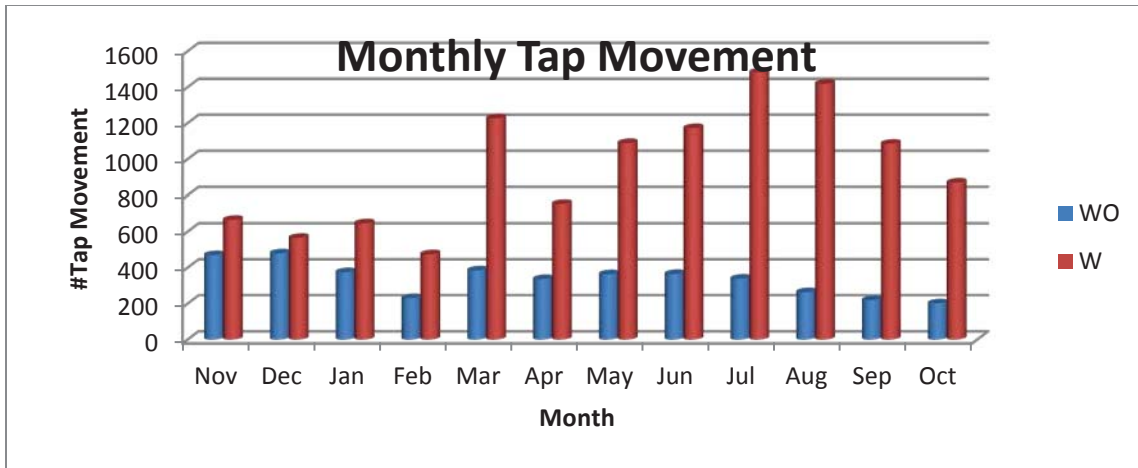

Figure 3-31: Monthly Tap Movement with and without Project

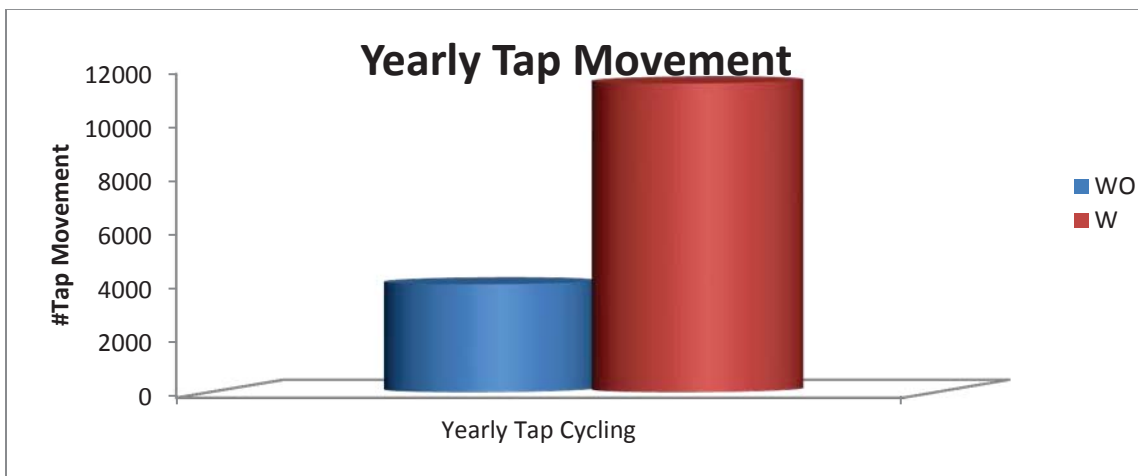

Figure 3-32: Yearly Tap Movement with and without Project

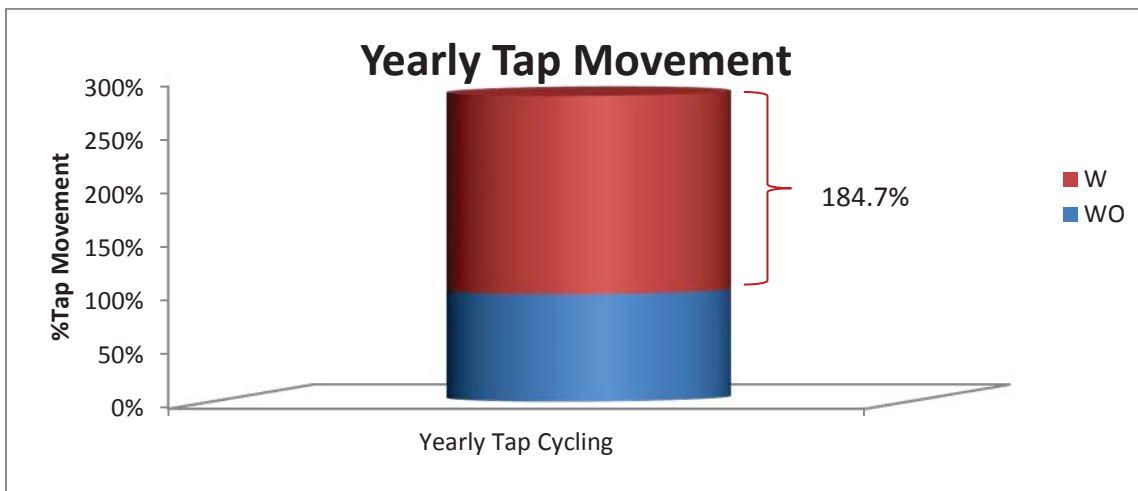

Figure 3-33: Yearly Incremental Tap Cycling Impact of Project

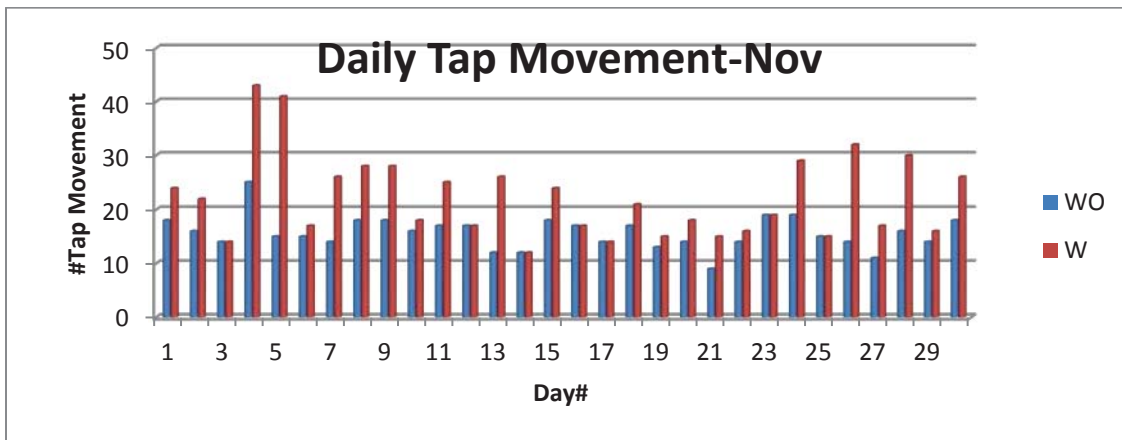

Figure 3-34: Monthly Tap Movement with and without Project-November

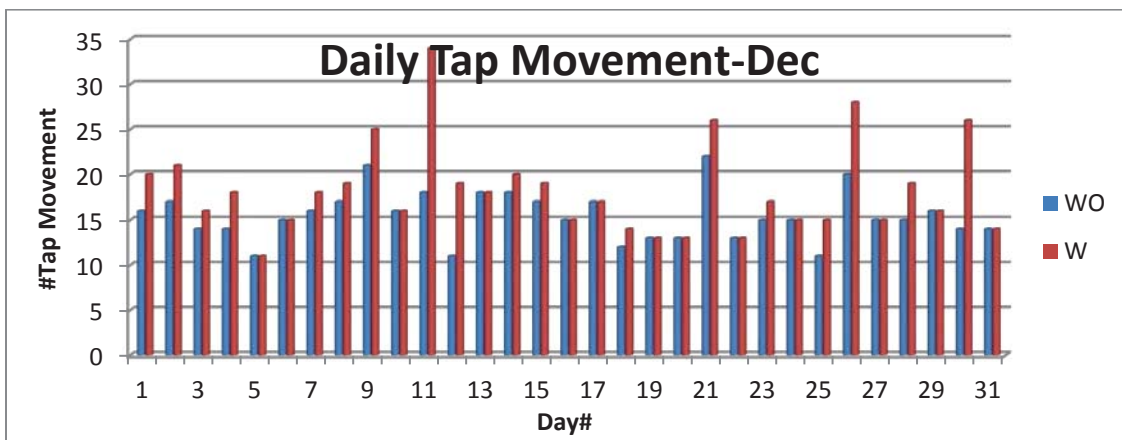

Figure 3-35: Monthly Tap Movement with and without Project-Dec

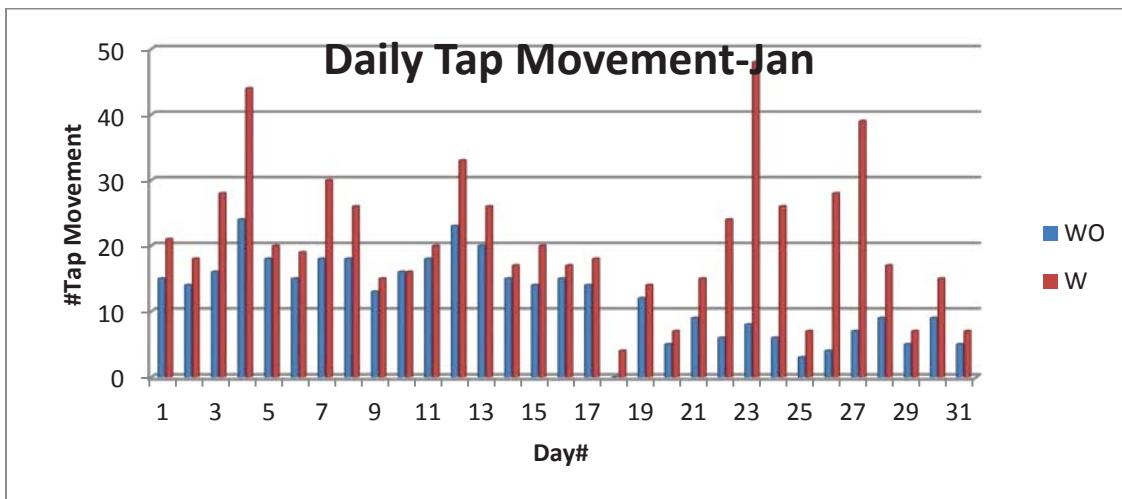

Figure 3-36: Monthly Tap Movement with and without Project - January

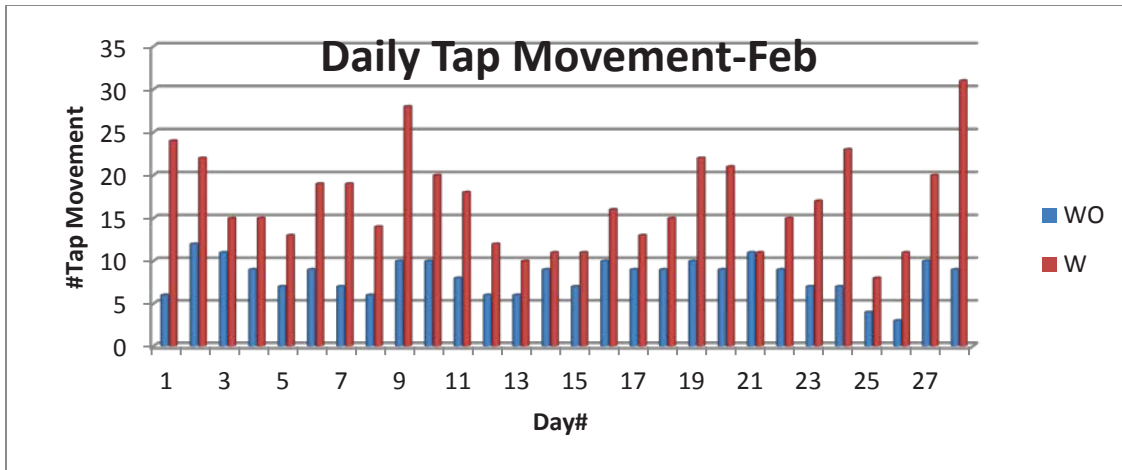

Figure 3-37: Monthly Tap Movement with and without Project - February

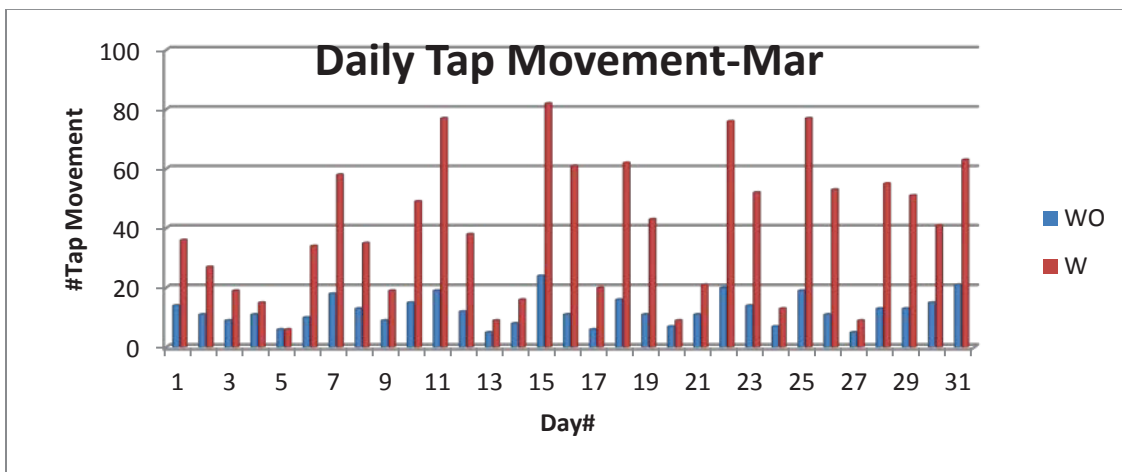

Figure 3-38: Monthly Tap Movement with and without Project - March

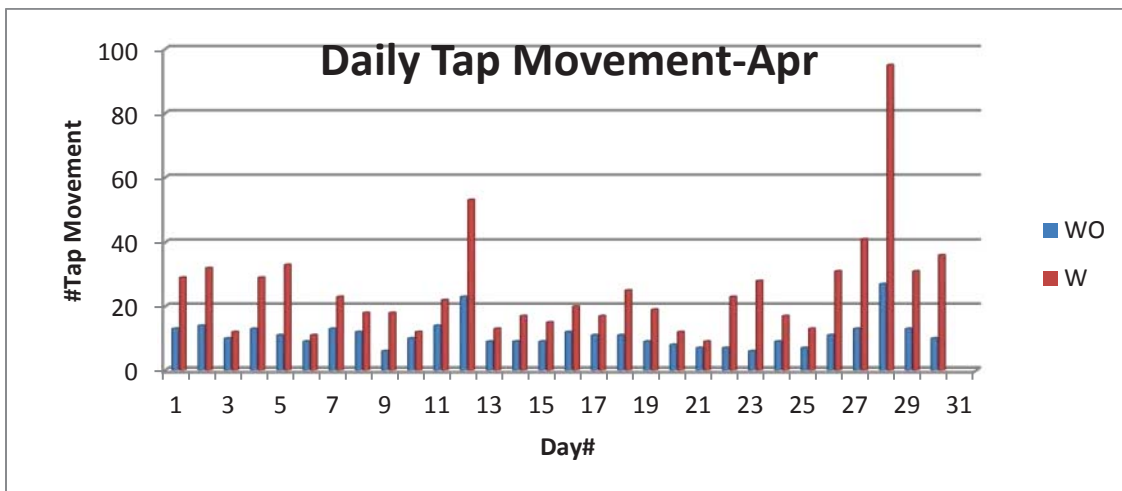

Figure 3-39: Monthly Tap Movement with and without Project - April

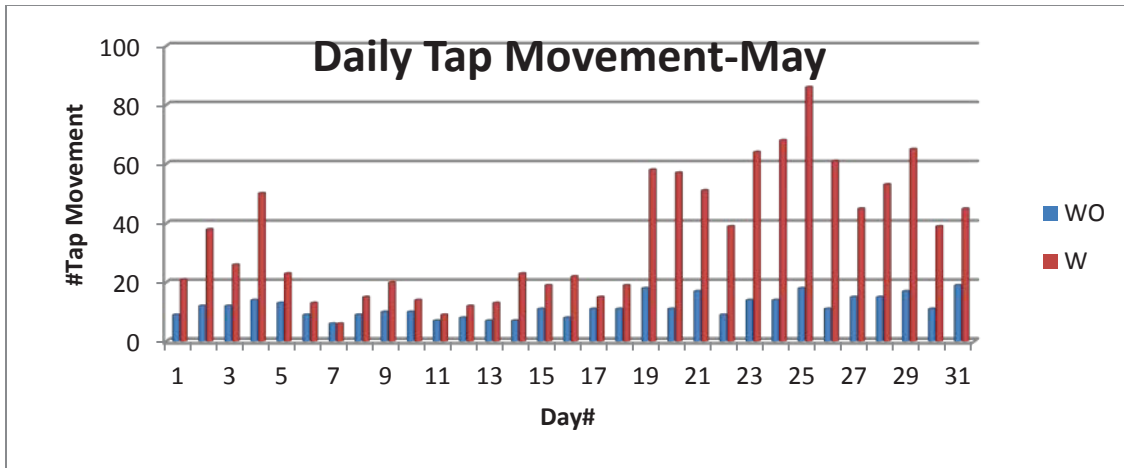

Figure 3-40: Monthly Tap Movement with and without Project - May

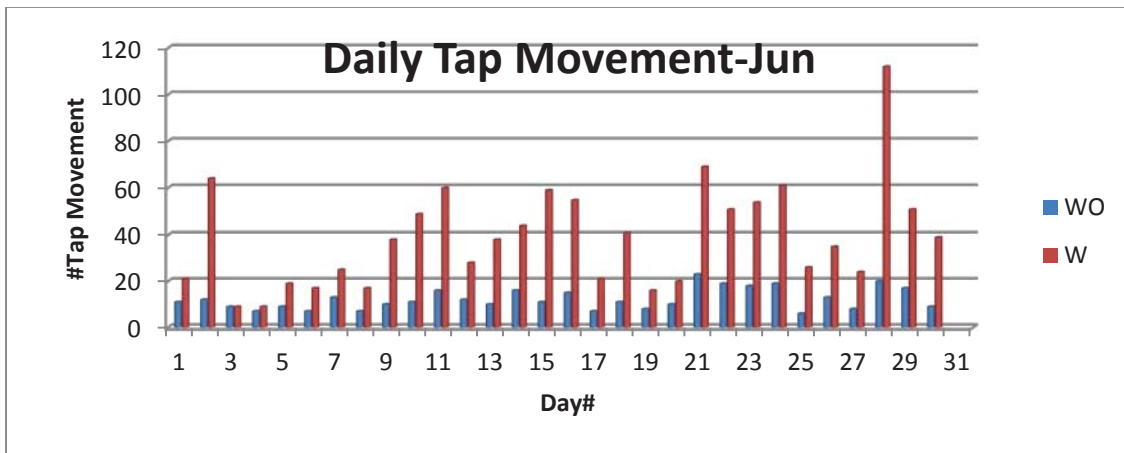

Figure 3-41: Monthly Tap Movement with and without Project - June

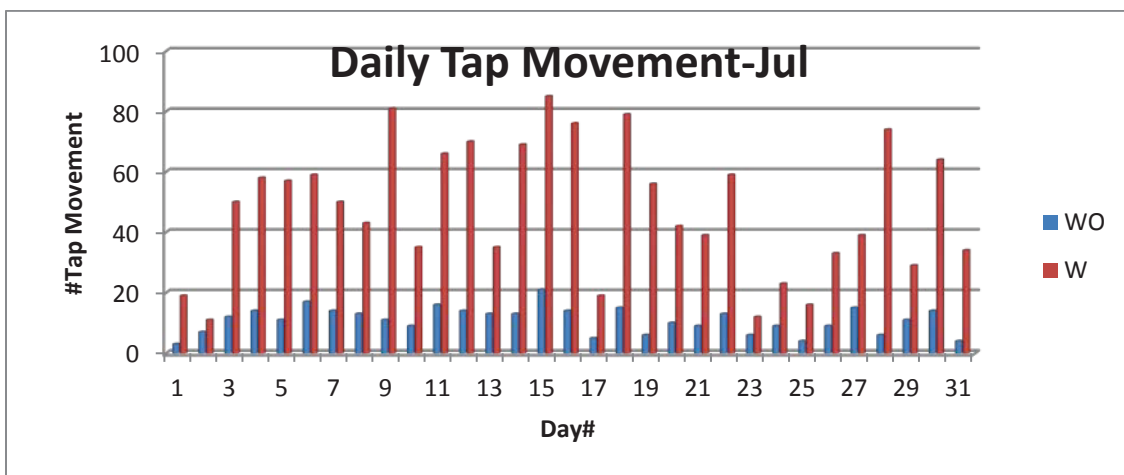

Figure 3-42: Monthly Tap Movement with and without Project - July

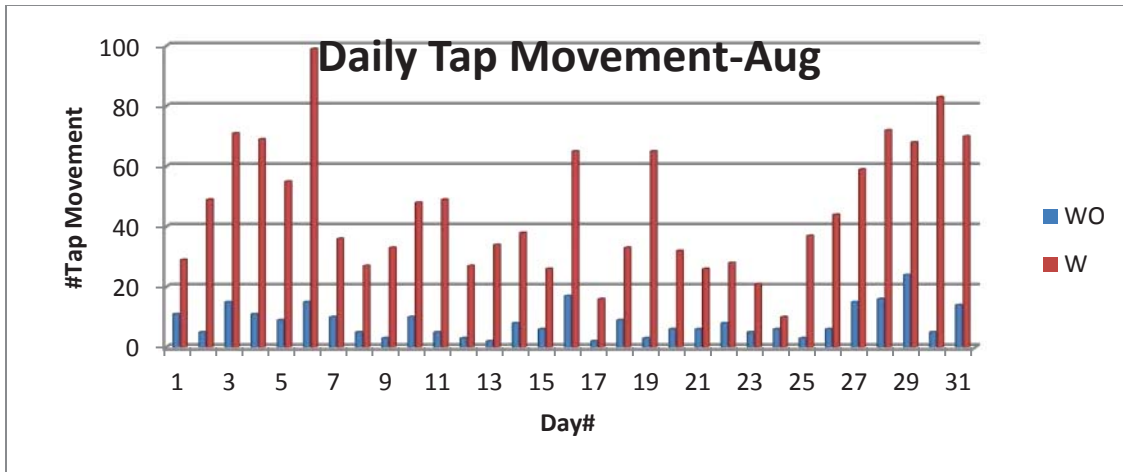

Figure 3-43: Monthly Tap Movement with and without Project - August

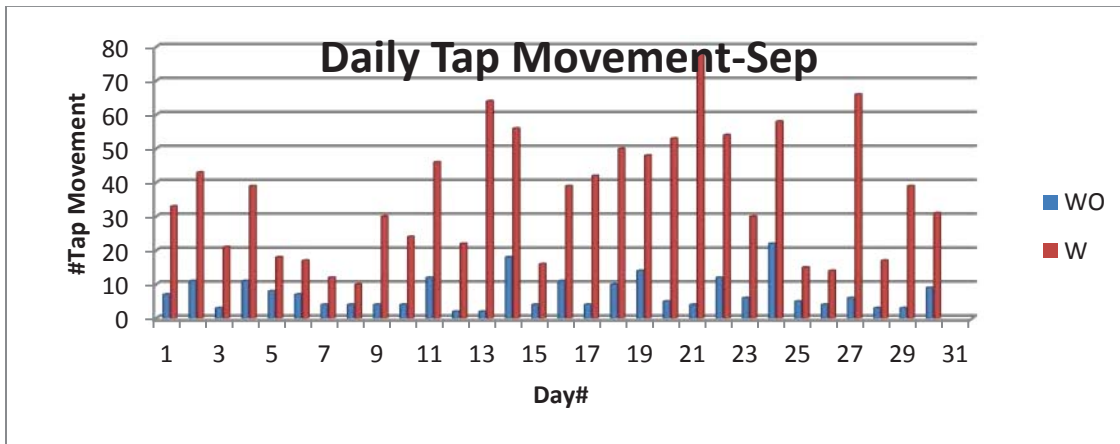

Figure 3-44: Monthly Tap Movement with and without Project - September

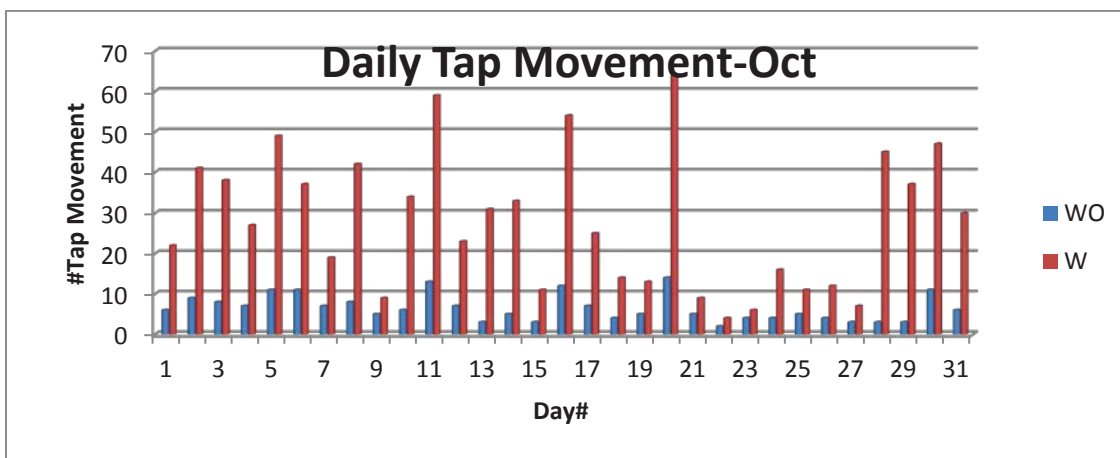

Figure 3-45: Monthly Tap Movement with and without Project - October

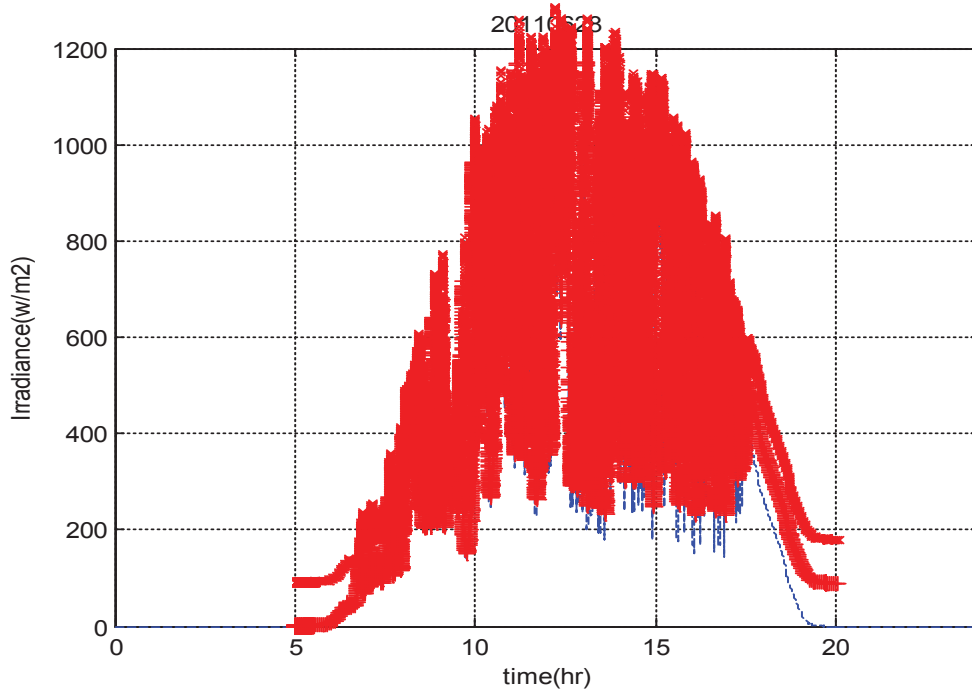

Figure 3-46: Irradiation Pattern which Lead to Maximum Tap Cycling Contribution of Single-Phase NEM (28th Jun 2011)

3.5. Flicker Assessment

Variable output of PV panels can cause flicker issues on circuits with high PV penetration. This section presents the evaluation of the potential flicker impact of the Project.

IEC std. 61000 provides two quantities to characterize flicker severity; Pst (a measure of short term flicker perception obtained for a ten minutes interval) and Plt (a measure of long term flicker severity obtained for a two-hour period). Figure 3-47 show block-diagram of IEC short term flicker meter. Plt is calculated using twelve consecutive Pst values as:

$$P_{lt} = \sqrt[3]{\frac{\sum_{i=1}^{12} (P_{st}^i)^3}{12}}$$

Regarding IEEE Std. 1453, Pst and Plt values on 12.47 KV circuits, respectively, should not exceed .9 and .7 more than 1% of the time(99% probability level), with a minimum assessment period of one week.

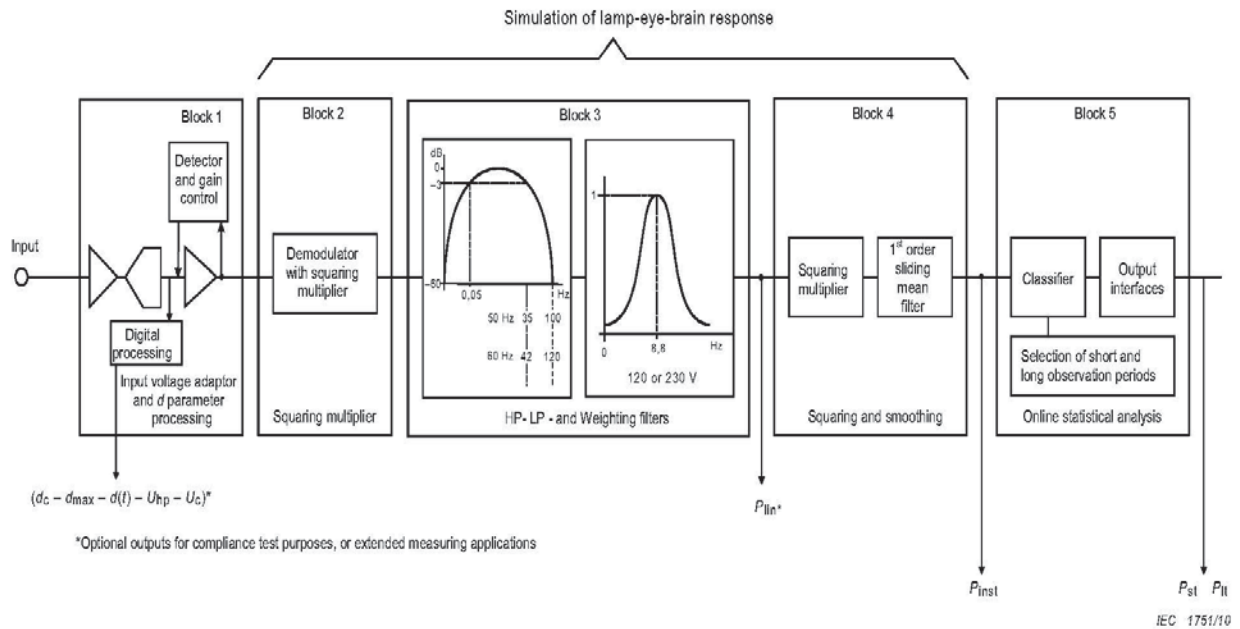

Figure 3-47: Functional Diagram for an IEC Digital Flickermeter (Source: IEC 61000-4-15:2010).

In this study, maximum daily Pst and Plt values are used to evaluate impending flicker contribution of the Project. Yearly irradiation (average of nineteen measurements) and load data (Section 3.4) are used to simulate Pst/Plt variation.

Figure 3-48 and Figure 3-49 demonstrate maximum value of Pst and Plt occurred on each month without and with 3220 KW NEM PV. Blue and red bars represent maximum monthly flicker severity before and after the addition of the Project, respectively. Project increases maximum yearly Pst (Plt) value from .24 (.19) to .42 (.32). Although Project increases voltage flicker, both Pst and Plt values stay within the IEEE Std.1453 limits and no violation is observed. Figure 3-50 through Figure 3-61 and Figure 3-62 through Figure 3-73, respectively, show maximum daily Pst and Plt values for all days of simulated year before and after addition of the Project.

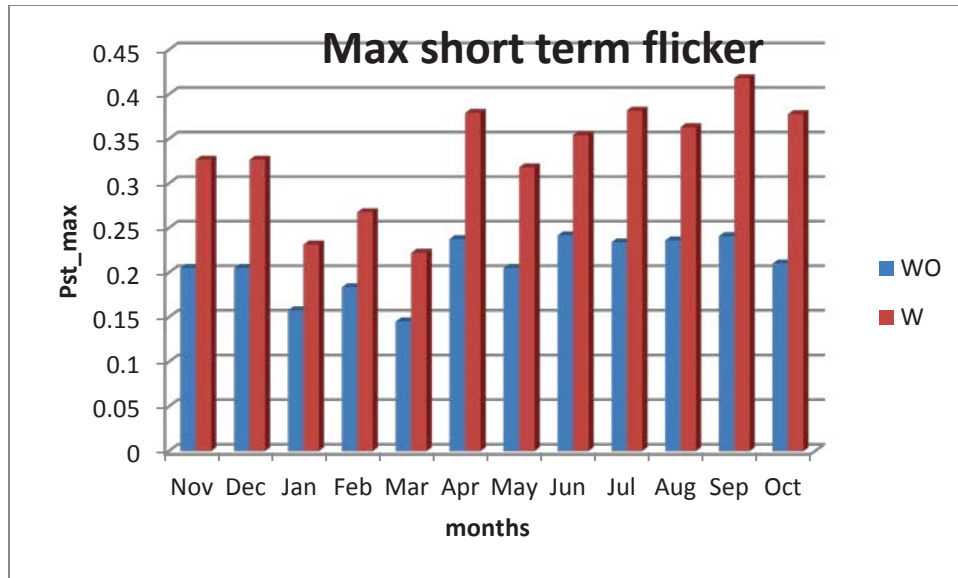

Figure 3-48: Maximum Monthly Pst with and without Project

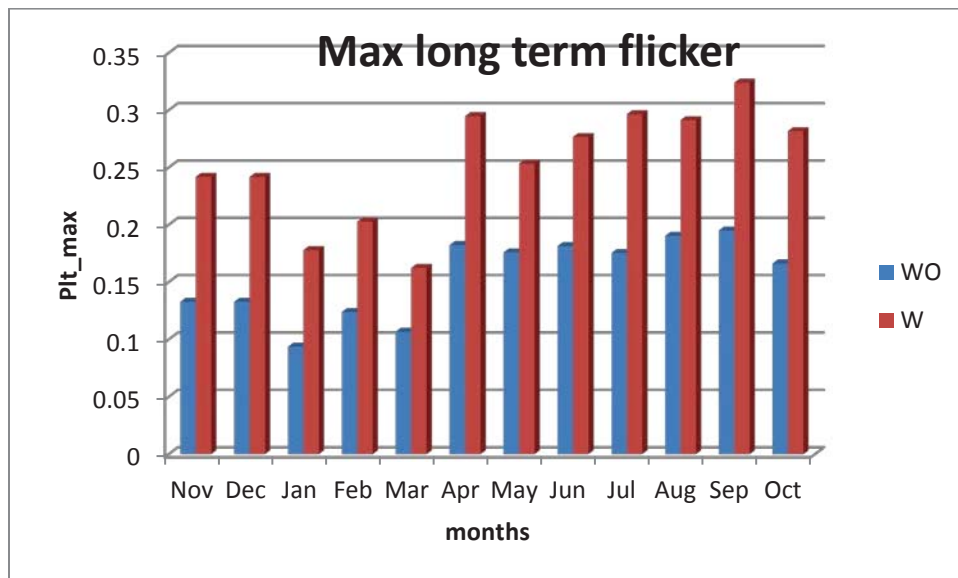

Figure 3-49: Maximum Monthly Plt with and without Project

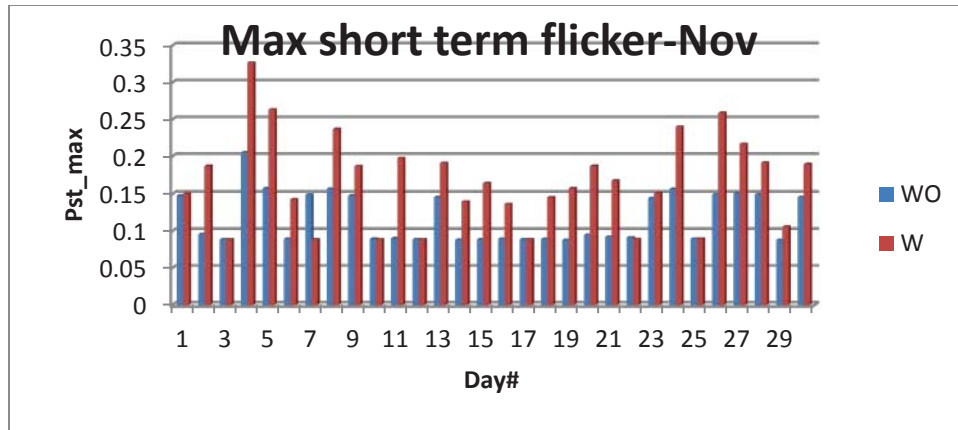

Figure 3-50: Maximum Daily Pst with and without Project-Nov

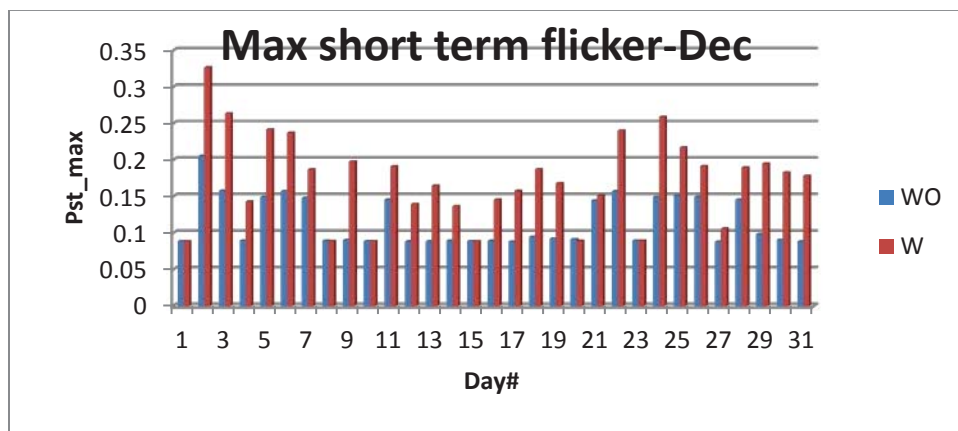

Figure 3-51: Maximum Daily Pst with and without Project-Dec

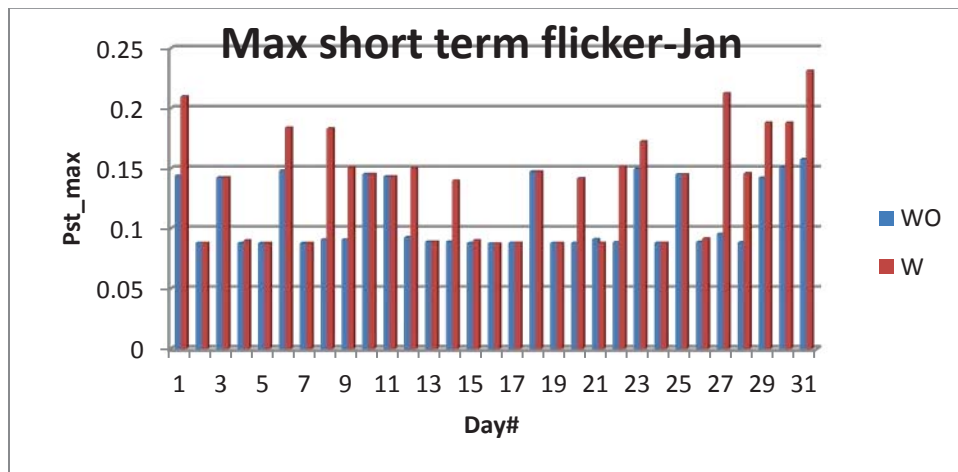

Figure 3-52: Maximum Daily Pst with and without Project-Jan

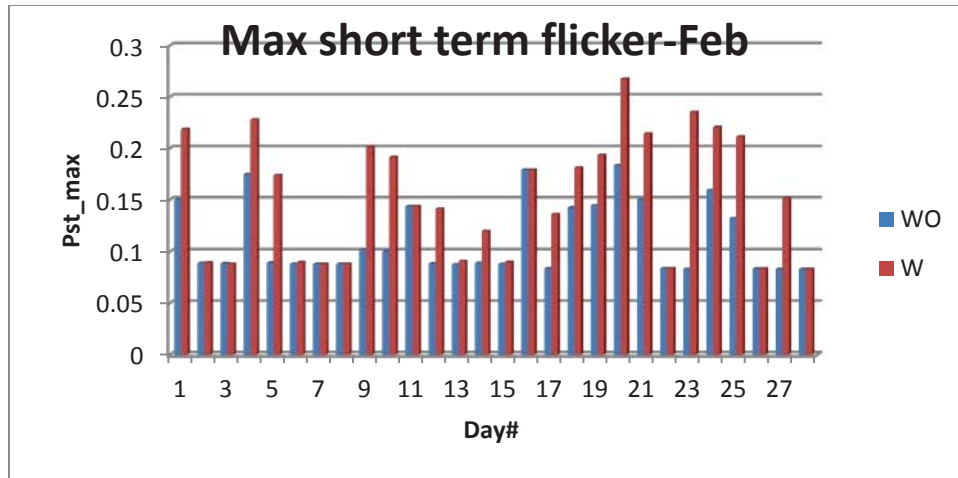

Figure 3-53: Maximum Daily Pst with and without Project-Feb

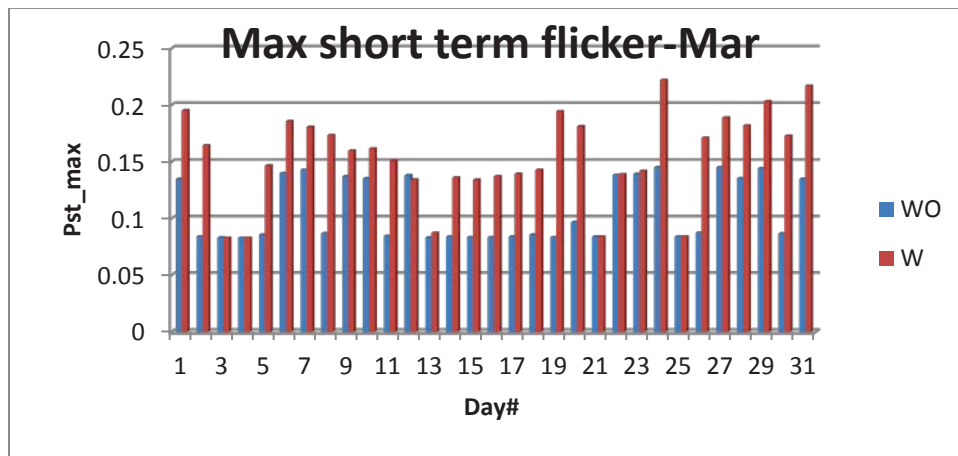

Figure 3-54: Maximum Daily Pst with and without Project-Mar

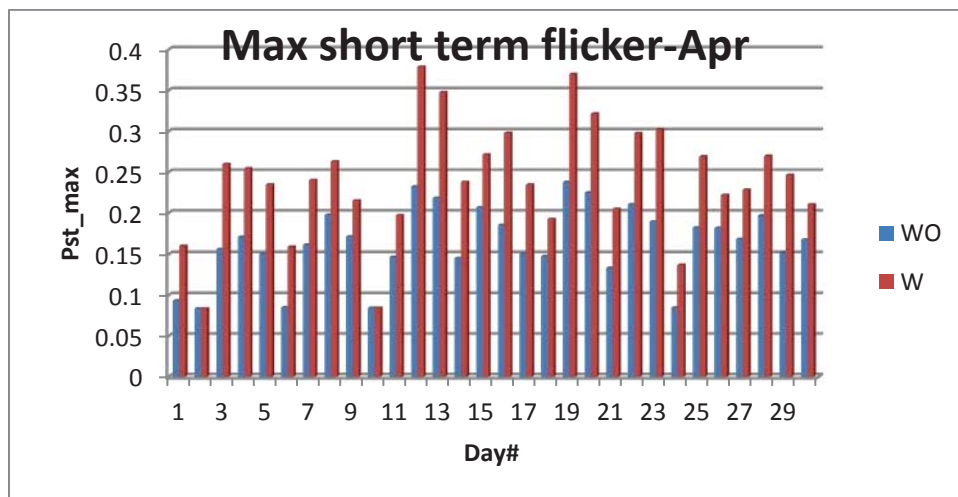

Figure 3-55: Maximum Daily Pst with and without Project-Apr

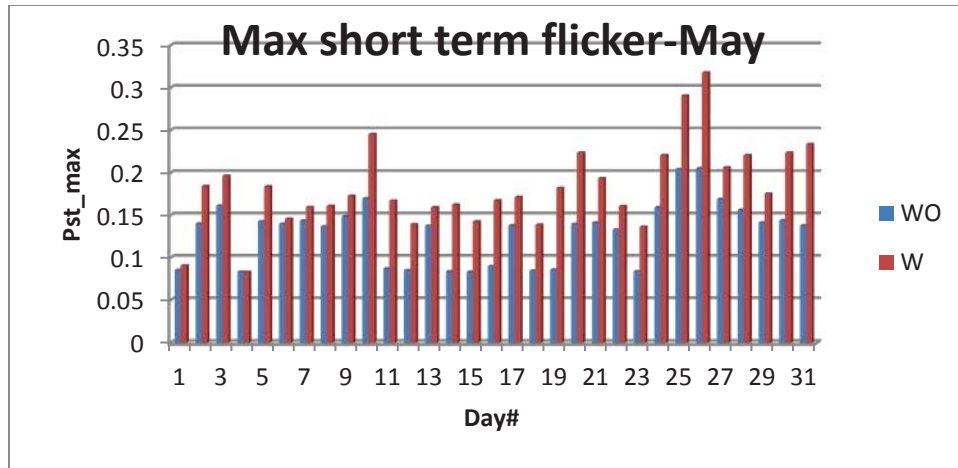

Figure 3-56: Maximum Daily Pst with and without Project-May

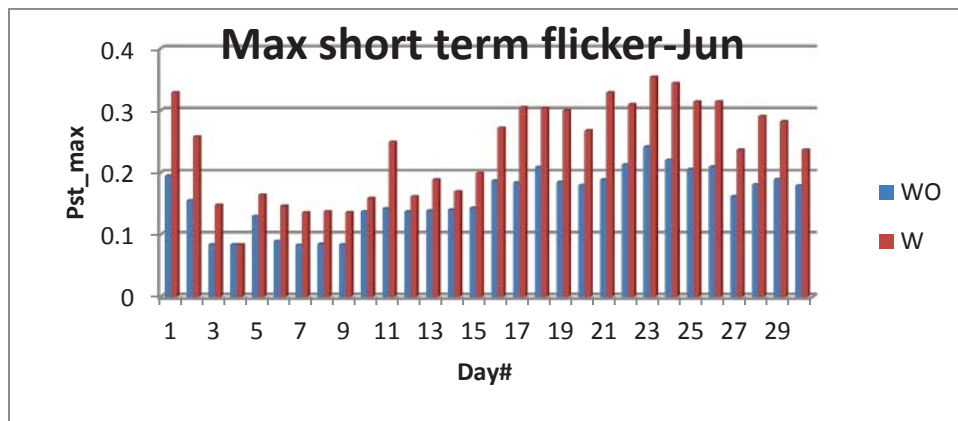

Figure 3-57: Maximum Daily Pst with and without Project-Jun

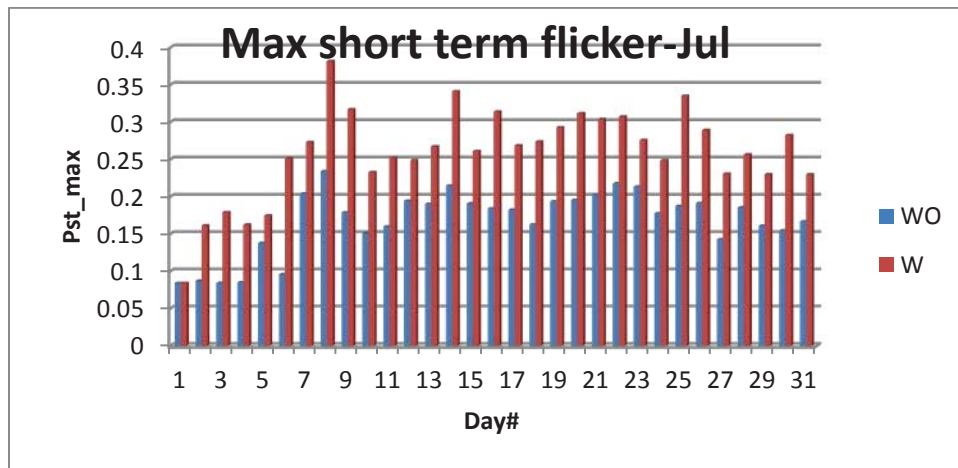

Figure 3-58: Maximum Daily Pst with and without Project-Jul

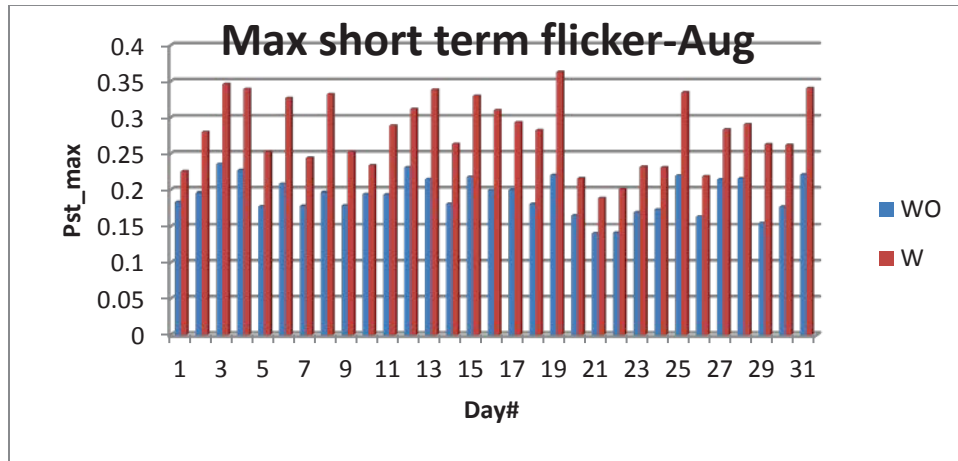

Figure 3-59: Maximum Daily Pst with and without Project-Aug

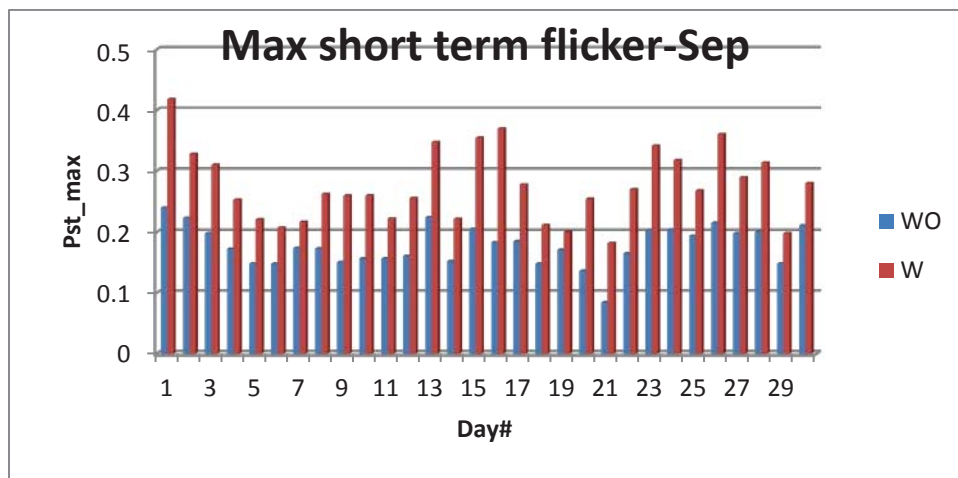

Figure 3-60: Maximum Daily Pst with and without Project-Sep

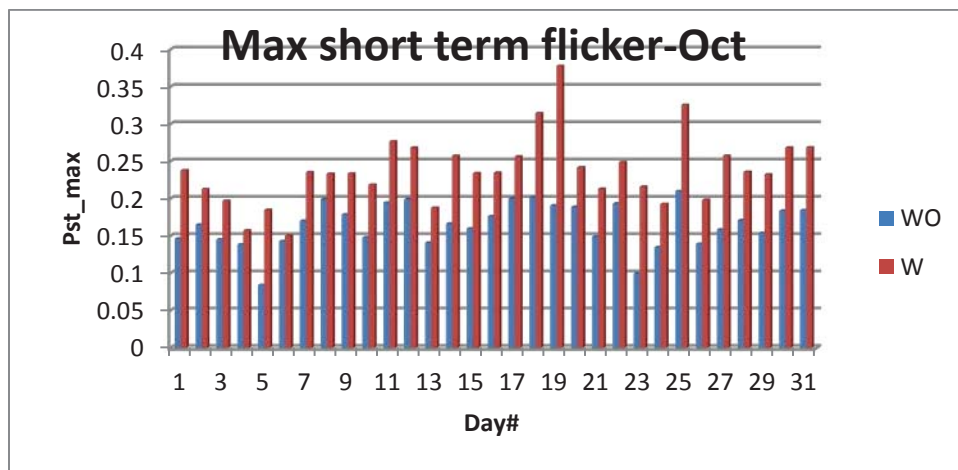

Figure 3-61: Maximum Daily Pst with and without Project-Oct

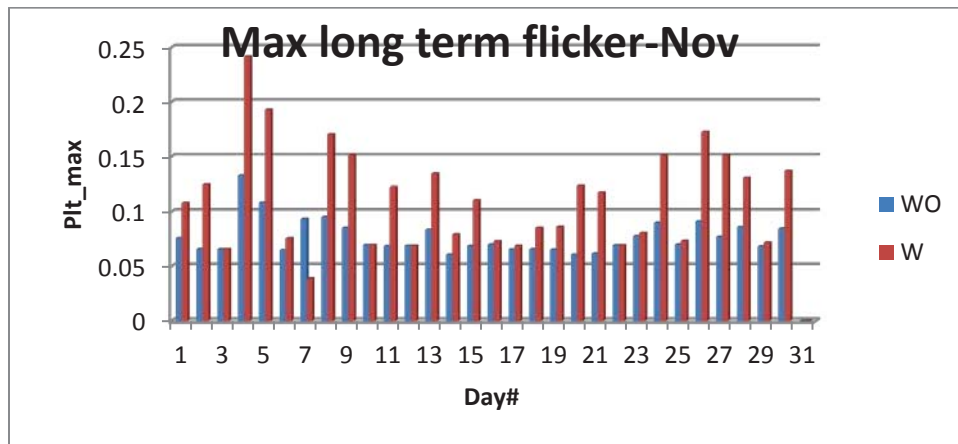

Figure 3-62: Maximum Daily Pflt with and without Project-Nov

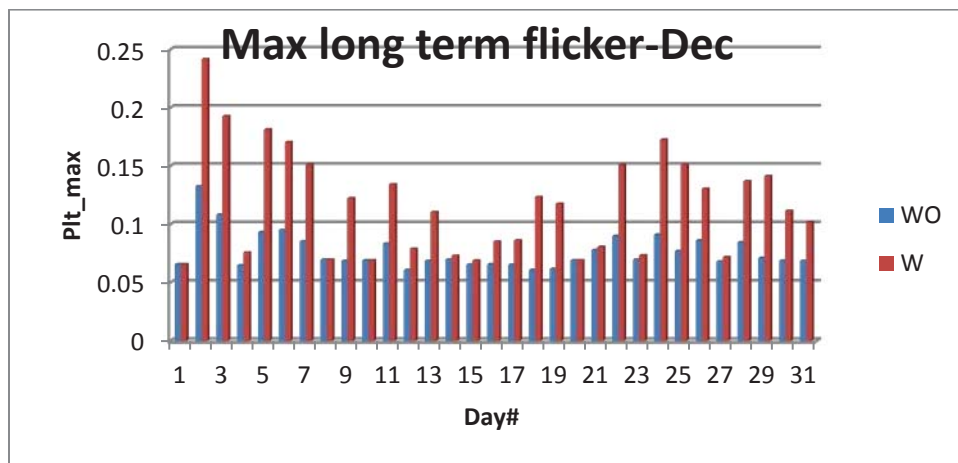

Figure 3-63: Maximum Daily Pflt with and without Project-Dec

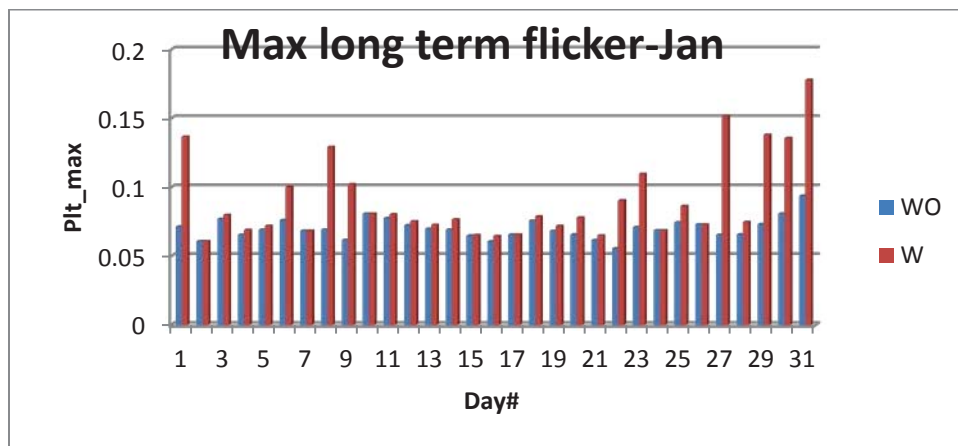

Figure 3-64: Maximum Daily Pflt with and without Project-Jan

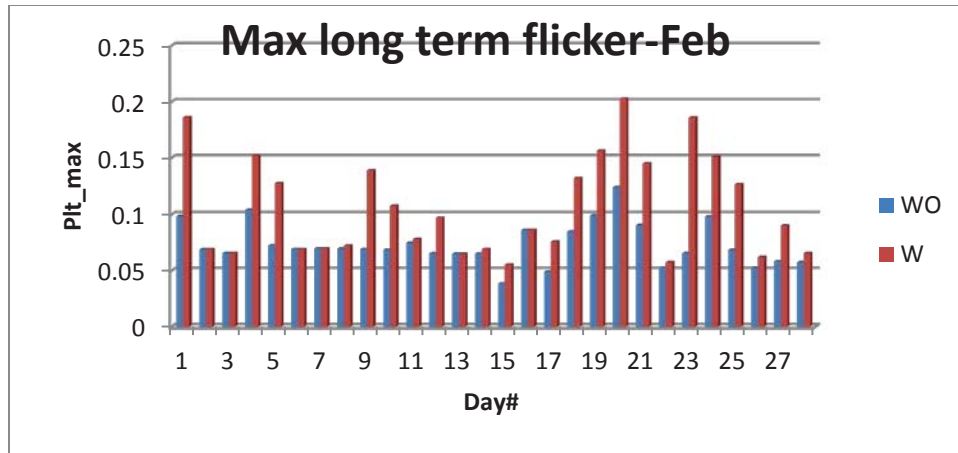

Figure 3-65: Maximum Daily PIt with and without Project-Feb

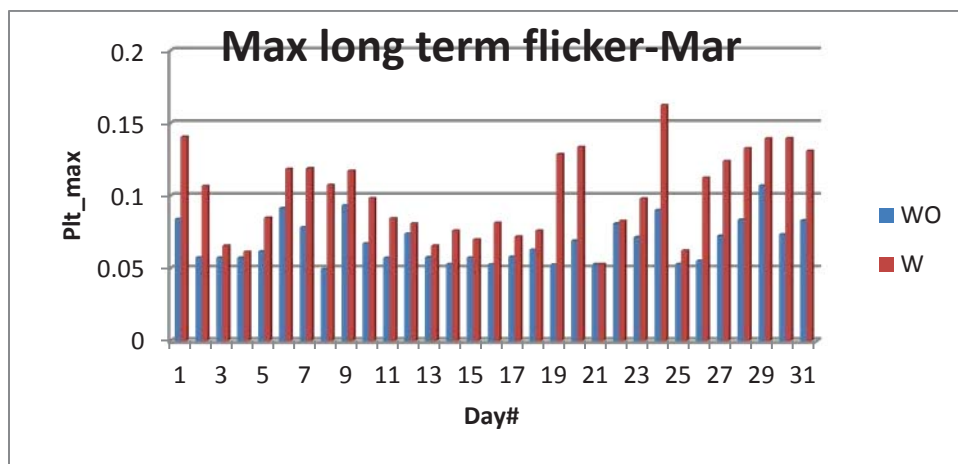

Figure 3-66: Maximum Daily PIt with and without Project-Mar

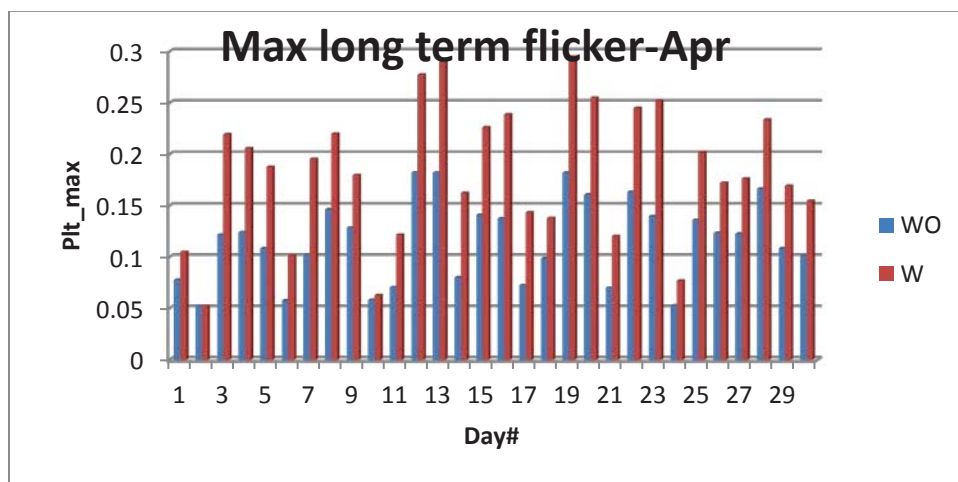

Figure 3-67: Maximum Daily PIt with and without Project-Apr

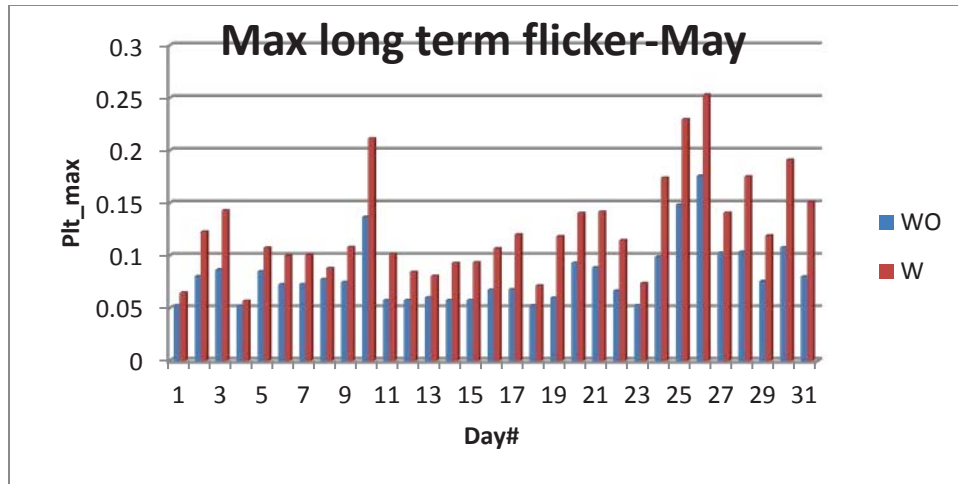

Figure 3-68: Maximum Daily PIt with and without Project-May

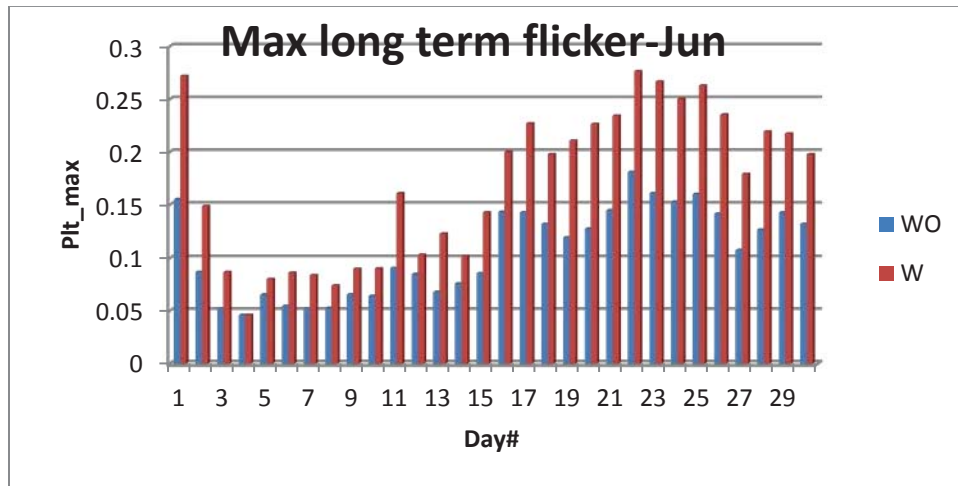

Figure 3-69: Maximum Daily PIt with and without Project-Jun

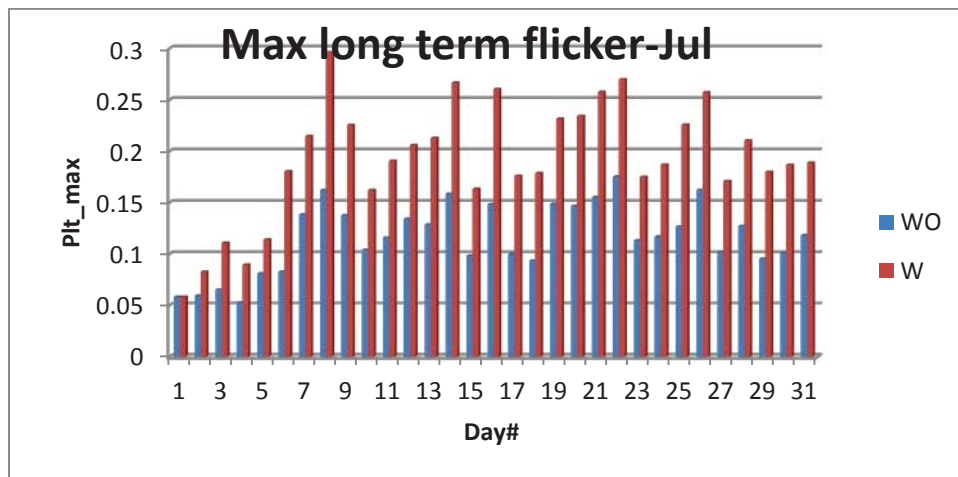

Figure 3-70: Maximum Daily PIt with and without Project-Jul

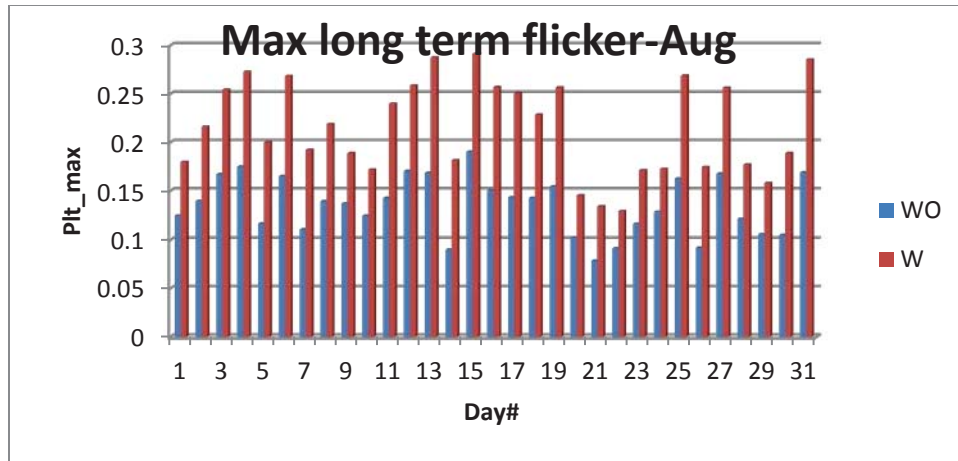

Figure 3-71: Maximum Daily Plt with and without Project-Aug

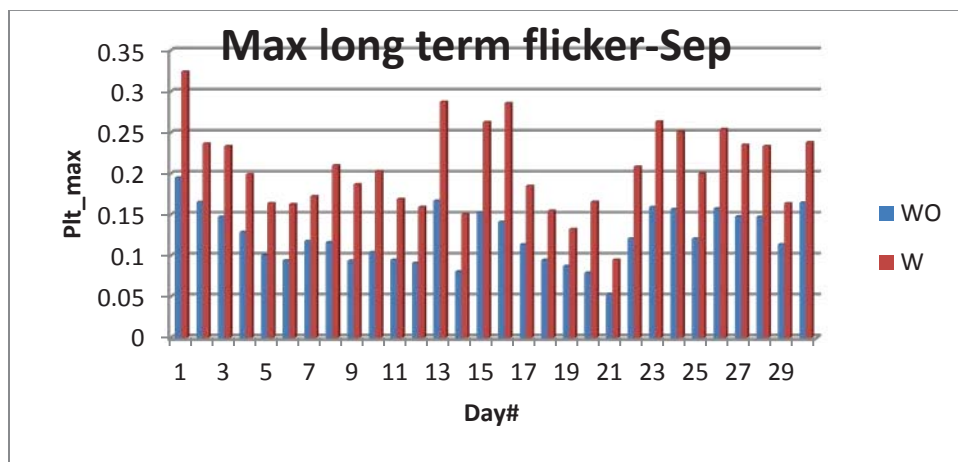

Figure 3-72: Maximum Daily Plt with and without Project-Sep

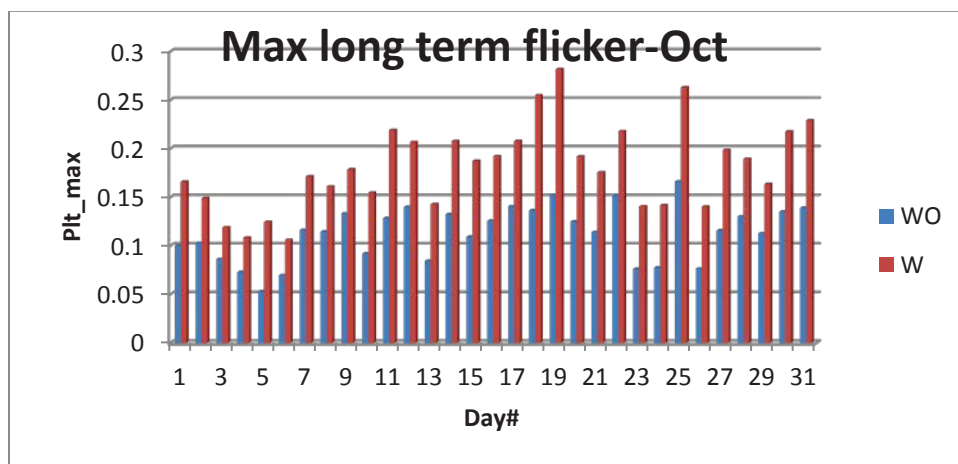

Figure 3-73: Maximum Daily Plt with and without Project-Oct

3.6. Conclusions

- Daily/yearly QSS analysis was conducted in this section to demonstrate impending effects of load and irradiation profile as well as shadow movement. Considering the simulation results, NEM penetration limit suggested in section 2 (i.e. 4179 kW) needs to be further reduced to 3223 kW. This reduction keep voltage imbalance close to the limits recommended by NEMA MG1-1993.
- Yearly simulation suggests 185% incremental tap cycling due to 3,223 kW single phase NEM units. Hawaiian Electric may need to evaluate the maintenance and operation procedure for the LTC to prevent premature damage.
- The LTC should be set as "ignore". Setting the LTC as lock-to-neutral would significantly increase tap cycling.
- The impact of unbalance current caused by single phase PV penetration at about 3223 kW would not negatively affect ground relay performance at the substation and would not negatively affect the ground protection performance for recloser.
- Considering yearly/daily simulations, Project (3223 KW NEM) is not likely to cause voltage flicker violation.

Section 4. Fault Analysis and Coordination of Protective Devices

This section discusses the potential impacts of the NEM units on short circuit current levels and coordination of protective devices on the study feeders. The penetration level of NEM units on the study feeders is determined from steady state load flow analysis.

4.1. Methodology

The approach used in this study follows these steps:

1. The fault current levels are calculated for the existing system before and after the addition of the NEM units. The NEM units are assessed on the basis of whether or not they cause fault levels to exceed the following duty ratings for the related devices on the distribution circuit:
 - short circuit rating of interrupting devices at the main substation of 25 kA, and
 - fused cutout commonly interrupting rating of approximately 12 kA.
2. Review of the existing coordination of protective devices on the distribution circuits. If any issue on protective coordination is found, the proposed solution is provided to mitigate the negative impact of this issue.
3. The assessment of the potential impacts of the NEM units on the loss of coordination.

The short circuit coordination during normal circuit configuration is studied in details first. The results are presented in Section 4.2 through 4.4. Emergency condition I is studied where part of H111-2 Circuit is fed through TSF-H110. The results are presented in Section 4.5.

The industry uses a “rule of thumb” of 2 times rated current for the amount of fault current contributed by inverter-based distributed generation. This assumption is used for the fault analysis in Section 3.2 and Section 3.3.

At the same time, National Renewable Energy Laboratory (NREL) and Southern California Edison (SCE) tested 20 single-phase residential PV inverters from multiple manufacturers with sizes between 1.5 and 7 kW⁸. It reveals that the fault current peak could be as high as 7 times rated current which generally lasts no more than 1 cycle. Therefore, Section 4.4 will adjust

⁸ J. Keller et al., Fault current contribution from single-phase PV inverters, 37th IEEE Photovoltaic Specialists Conference (PVSC), pp. 001822 - 001826, 2011

the short circuit model and increase the fault contribution from NEM units from 2 times to 7 times rated current.

Table 4-1 summarizes existing interrupting devices and their corresponding settings. Table 4-2 summarizes the coordination paths under different scenarios. Figure 4-1 shows the location of the faults (red dots) and protection devices on H111-2, H111-1 and H110-1 Circuits. During normal condition, only H111-2 and H111-1 Circuits are studied.

Table 4-1: Specifications of Interrupting Devices

Devices	Manufacturer	Model/Type	Curve	min. operating time	Pick up Current	Time Dial	CT Ratio
CB H111-2	GE	IAC	Phase: Extremely Inverse	-	5.00	2.25	120
			Ground: Extremely Inverse		2.50	9.25	
CB H110-1	SEL	SEL351	Phase: Extremely Inverse	-	2.80	3.75	120
			Ground: Extremely Inverse		1.92	6.00	
CB H111-1	SEL	SEL251C	Phase: Extremely Inverse	-	2.80	5.00	120
			Ground: Extremely Inverse		1.92	8.50	
			Negative: Extremely Inverse		4.20	6.20	
Recloser #80	Cooper	Form5	Phase: Kyle116X1.3	-	520	-	1000
			Ground: Kyle165X1.1		230		
Recloser #60	Cooper	Form5	Phase: Kyle116X1.5	-	520	-	1000
			Ground: Kyle165X1.5		230		
Recloser #59	Cooper	Form5	Phase: K105	12 cycles	420	-	1000
			Ground: K111		170		
Fuse	KEARNEY	-	K series, Rating: 100, 80, 65, 40, 30, 25, 20, 15, 10, 5	-	-	-	-

Table 4-2: Coordination Paths Under Normal and Emergency Conditions

Scenario	Circuit/Path	Interrupting Devices
Normal	H111-2	BKR#H111-2, Recloser#60, 100 A Fuse
	H111-1	BKR#H111-1, 100 A Fuse
Emergency#1	H110-1 and H111-2	BRK#H110-1, Recloser#80, Recloser#59, 100 A Fuse

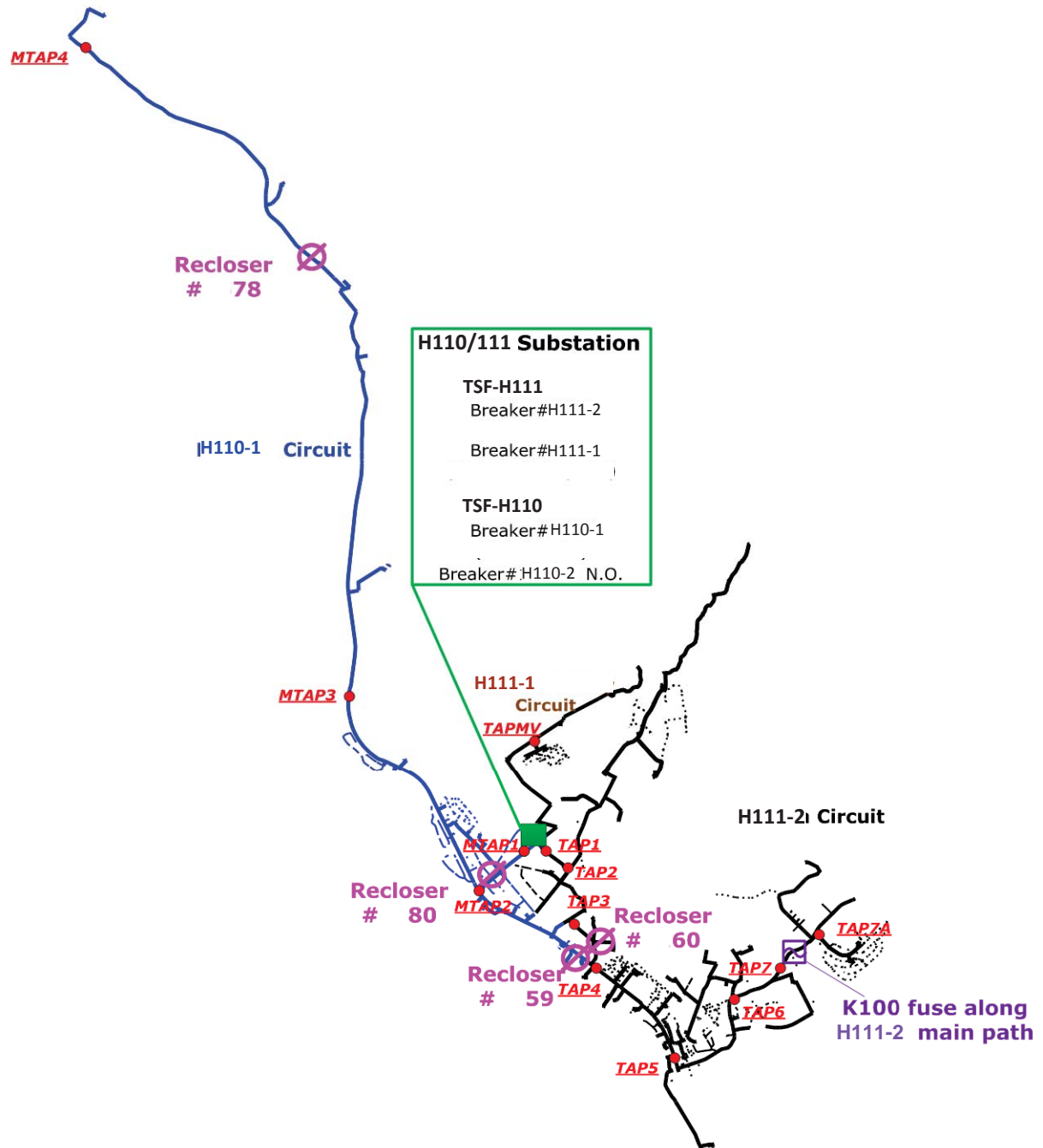

Figure 4-1: Protective Devices and Fault Locations on H111-2, H111-1 and H110-1 Circuits

4.2. Fault Analysis

Table 4-3 summarizes the single-line-to-ground (SLG) and three-line-to-ground (3LG) fault analysis results without any PV, with FIT only and with a total of 4197 kW NEM units on H111-2 and H111-1 Circuits. The amount of

fault current contribution from NEM units is also summarized. The NEM units will contribute no more than 144 A at 12.47 kV for SLG faults and 136 A for 3LG faults, respectively. This is not likely to exceed the rating of the existing interrupting equipment.

Table 4-3: Short Circuit Analysis Assuming Two Times of Rated Current (Unit: A)

	Bus Name	kV	SLG			3LG			NEM Contribution	
			PV off	FIT only	FIT + NEM	PV off	FIT only	FIT + NEM	SLG	3LG
Primary side of TSF-H111	TSF-H111	46	895	901	908	1475	1499	1529	7	30
H111-2 Circuit	TAP1	12.47	3522	3587	3731	2849	2906	3042	144	136
	TAP2	12.47	2993	3043	3176	2614	2673	2806	133	133
	TAP3	12.47	1931	1935	1998	1952	1960	2039	63	79
	TAP4	12.47	1846	1877	1985	1947	2005	2122	108	117
	TAP5	12.47	1453	1476	1570	1648	1698	1801	94	103
	TAP6	12.47	1195	1212	1292	1431	1472	1560	80	88
	TAP7	12.47	1041	1054	1123	1298	1331	1408	69	77
	TAP7A	12.47	1010	1022	1088	1269	1301	1375	66	74
H111-1 Circuit	TAPMV	12.47	2888	2925	3028	2286	2315	2409	103	94

Note: NEM units are assumed to contribute a fault current of 2 times of rated current

4.3. Coordination of Protective Devices

4.3.1. Time Current Curves for 12.47 kV Distribution circuit

In this section, the time current curves (TCC) of phase protection and ground protection are plotted to review the existing protective coordination.

Figure 4-2 and Figure 4-3 show that protective devices are well coordinated during normal operation on the H111-2 Circuit. Figure 4-4 and Figure 4-5 show TCC of phase and ground protection devices for H111-1 Circuit. The protective devices of the study feeders are well coordinated during normal condition.

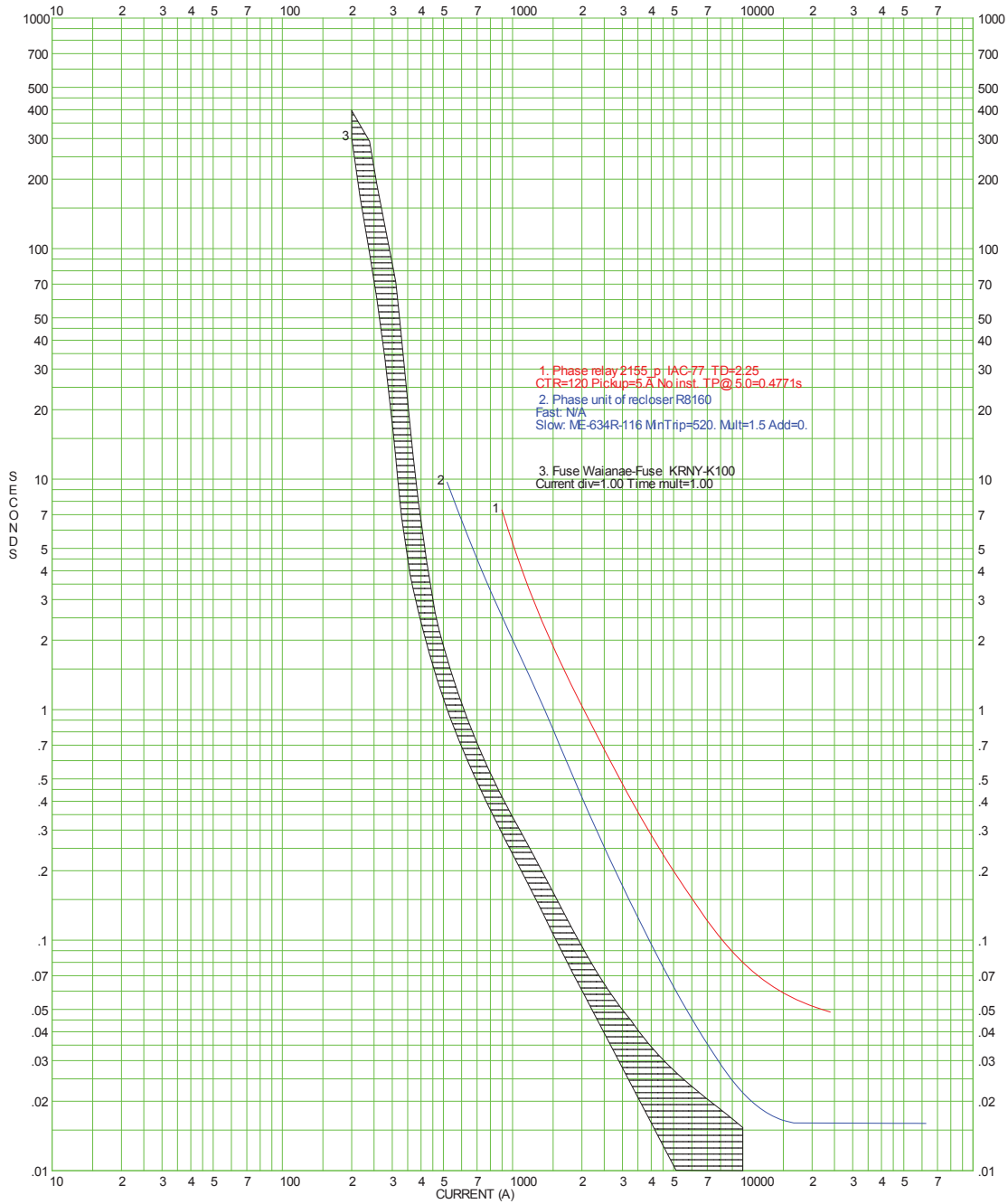

Figure 4-2: Phase Protection Coordination of H111-2 Circuit

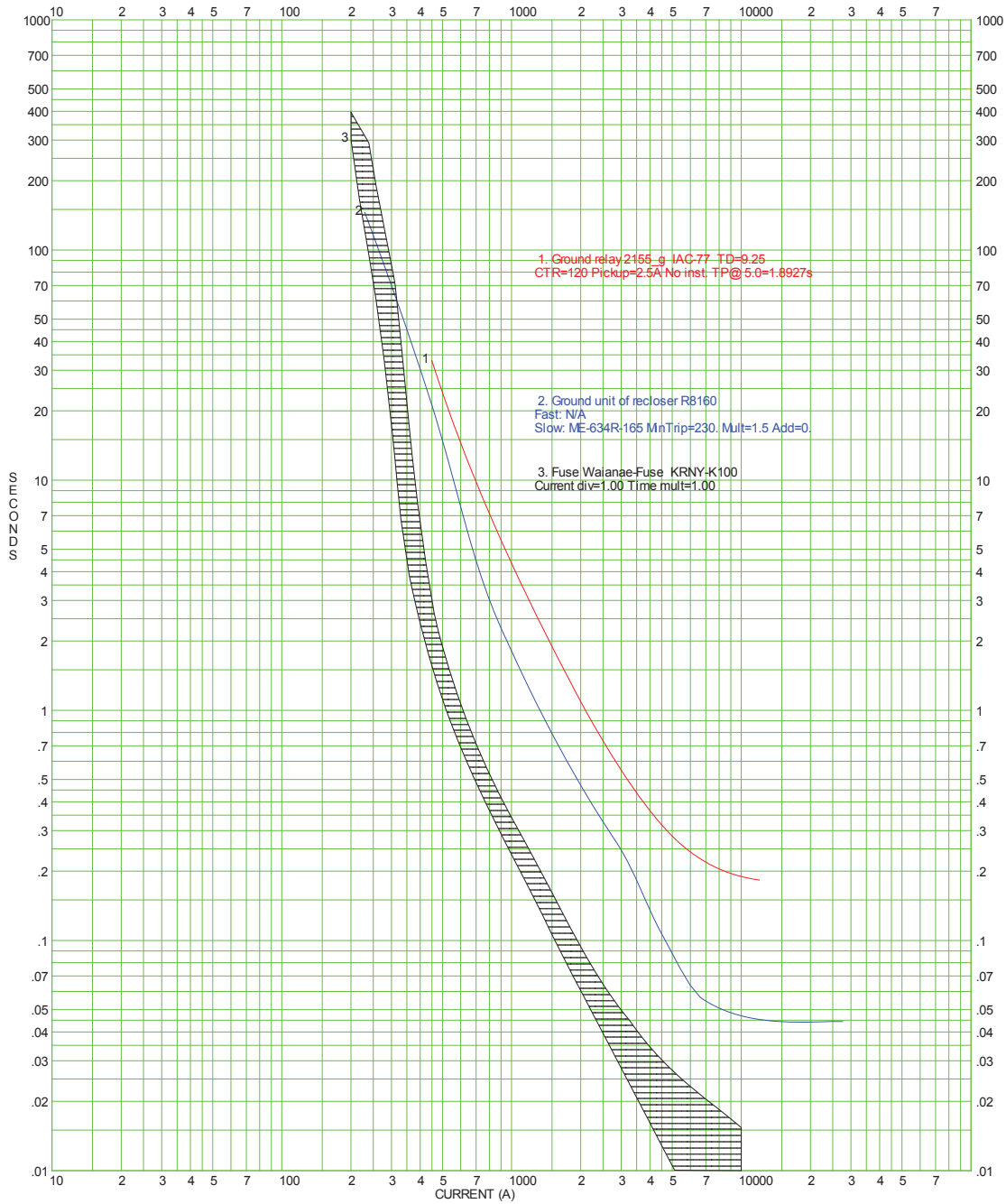

Figure 4-3: Ground Protection Coordination of H111-2 Circuit

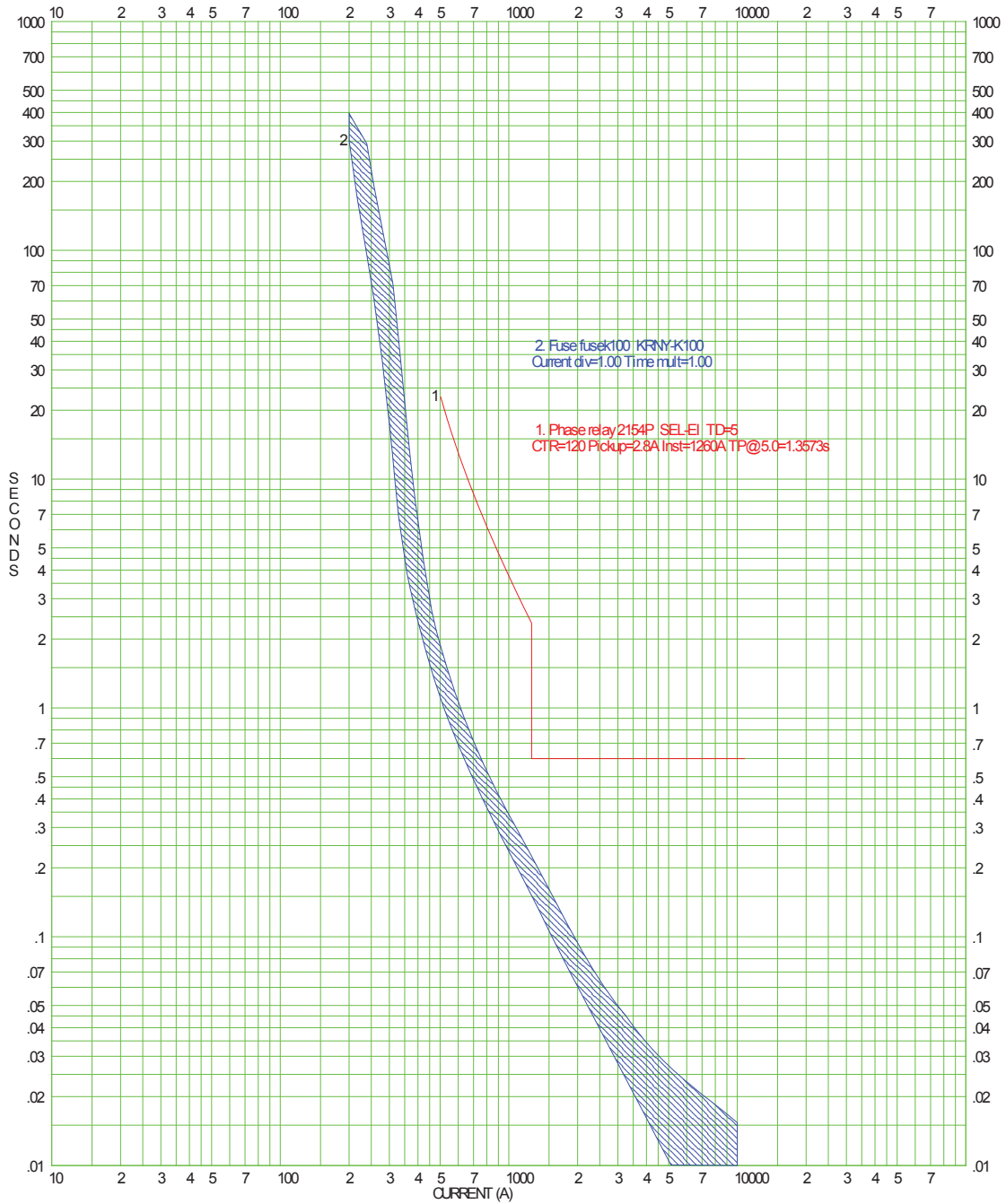

Figure 4-4: Phase Protection Coordination of H111-1 Circuit

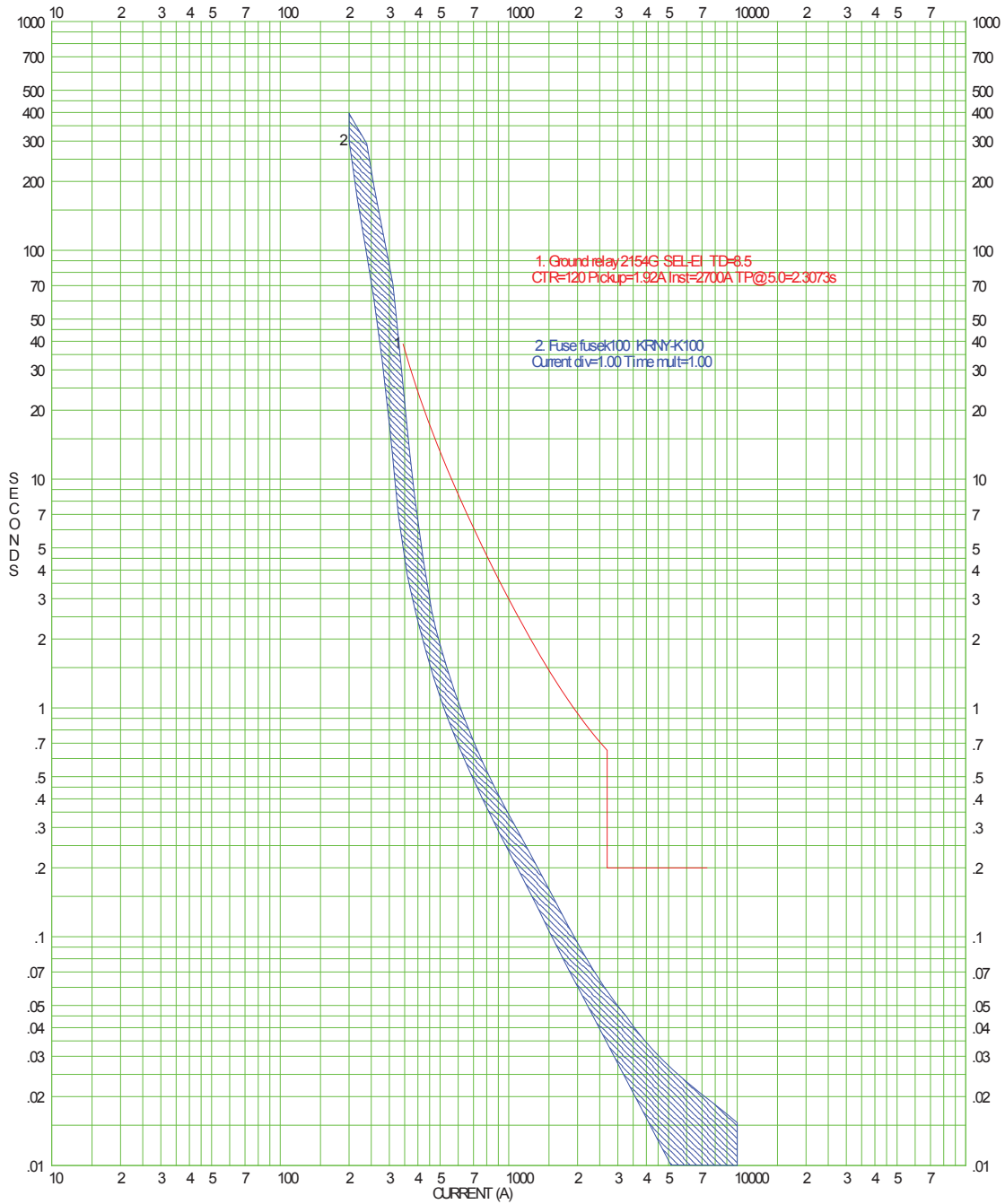

Figure 4-5: Ground Protection Coordination of H111-1 Circuit

4.3.2. Relay Response Simulations

In order to evaluate impending changes in clearing times of interrupting devices, this section presents the simulation studies of the relay response at the 12.47 kV level. Table 4-4 and Table 4-5 summarize the clearing time of the first protection device under normal condition for SLG faults and 3LG faults, respectively.

The maximum difference on clearing time without and with NEM units on the study feeders is no more than 0.025s which is 1.5 cycles. The performance of the existing protective devices is not likely to be impacted by the NEM units.

Table 4-4: Time Response Simulation for SLG Faults

Fault Bus	FIT only			FIT + NEM			Time Difference (s)
	relay	current (A)	time (s)	relay	current (A)	time (s)	
TAP2	OC phase H111-2	2952	0.49	OC phase H111-2	2970	0.486	-0.004
TAP3	OC phase H111-2	1874	1.184	OC phase H111-2	1864	1.197	0.013
TAP4	recloser 60 p	1797	0.536	recloser 60 p	1807	0.529	-0.007
TAP5	recloser 60 p	1397	0.966	recloser 60 p	1400	0.961	-0.005
TAP6	recloser 60 p	1140	1.527	recloser 60 p	1137	1.534	0.007
TAP7	recloser 60 p	991	2.054	recloser 60 p	986	2.079	0.025
TAP7A	fuse	1022	0.330	fuse	1056	0.311	-0.019
TAPMV	OC phase H111-1	2925	0.600	OC ground H111-1	2996	0.600	0.000
<i>Maximum Time Difference</i>							<i>0.025</i>

Table 4-5: Time Response Simulation for 3LG Faults

Fault Bus	FIT only			FIT + NEM			Time Difference (s)
	relay	current (A)	time (s)	relay	current (A)	time (s)	
TAP2	OC phase H111-2	2614	0.619	OC phase H111-2	2628	0.612	-0.007
TAP3	OC phase H111-2	1915	1.133	OC phase H111-2	1909	1.140	0.007
TAP4	recloser 60 p	1958	0.439	recloser 60 p	1973	0.429	-0.010
TAP5	recloser 60 p	1653	0.653	recloser 60 p	1660	0.641	-0.012
TAP6	recloser 60 p	1429	0.916	recloser 60 p	1430	0.941	0.025
TAP7	recloser 60 p	1292	1.156	recloser 60 p	1288	1.161	0.005
TAP7A	fuse	1301	0.212	fuse	1342	0.198	-0.014
TAPMV	OC phase H111-1	2315	0.600	OC phase H111-1	2374	0.600	-0.000
<i>Maximum Time Difference</i>							<i>0.025</i>

4.4. Sensitivity Study with Higher Peak Current Magnitude during First-Cycle

Table 4-6 summarizes the fault current level with 4179 kW NEM units that contribute 7 times rated current on the study feeders during fault conditions. The maximum fault current contribution from NEM units is 485 A.

Table 4-6: Short Circuit Analysis Assuming Seven Times of Rated Current

	Bus Name	kV	SLG	3LG	NEM Contribution	
			FIT + NEM (7X)	FIT + NEM (7X)	SLG	3LG
Primary side of TSF-H111	TSF-H111	46	922	1597	21	98
H111-2 Circuit	TAP1	12.47	4072	3366	485	460
	TAP2	12.47	3491	3125	448	452
	TAP3	12.47	2145	2224	210	264
	TAP4	12.47	2250	2411	373	406
	TAP5	12.47	1805	2057	329	359
	TAP6	12.47	1495	1783	283	311
	TAP7	12.47	1295	1601	241	270
H111-1 Circuit	TAP7A	12.47	1253	1561	231	260
	TAPMV	12.47	3270	2629	345	314

Note: NEM units are assumed to contribute a fault current of 7 times of rated current

Table 4-7 summarizes the impact on clearing time with NEM units contributing 7 times rated current during fault condition. With the higher fault current from NEM units, the existing coordination is not impacted. The relay response time is changed for no more than 0.059s or 3.5 cycles, which is still insignificant.

Table 4-7: Time Response Simulation for SLG Faults Assuming Seven Times Rated Current for NEM Units

Bus Name	kV	SLG Faults			3LG Faults		
		time (s)	Relay	time diff* (s)	time (s)	Relay	time diff* (s)
TAP2	12.47	0.473	OC phase H111-2	-0.017	0.596	OC phase H111-2	-0.023
TAP3	12.47	1.223	OC ground H111-2	0.039	1.157	OC phase H111-2	0.024
TAP4	12.47	0.514	recloser 60 p	-0.022	0.406	recloser 60 p	-0.033
TAP5	12.47	0.951	recloser 60 p	-0.015	0.624	recloser 60 p	-0.029
TAP6	12.47	1.554	recloser 60 p	0.027	0.906	recloser 60 p	-0.010
TAP7	12.47	2.114	recloser 60 p	0.060	1.170	recloser 60 p	0.014
TAP7A	12.47	0.271	fuse	-0.059	0.169	fuse	-0.043
TAPMV	12.47	0.600	OC phase H111-1	0.000	0.600	OC phase H111-1	0.000
<i>Maximum Time Difference (s)</i>				<i>0.059</i>		<i>--</i>	<i>0.033</i>

*please refer to Table 4-4 and Table 4-5 for the columns with FIT only

4.5. Emergency Condition

During emergency condition I, recloser R59 is closed and recloser R60 is open. H111-2 Circuit downstream R60 is fed from H110-1 Circuit through R59 as illustrated in Figure 4-6. There is a total of 3043 kW NEM units on H111-2 Circuit downstream R60 which are connected to H110-1 Circuit during emergency condition I.

The existing protective devices are well coordinated as shown in Figure 4-7 and Figure 4-8. Table 4-8 shows the fault current levels assuming 2 times rated current from NEM units. The NEM units contribute no more than 100 A fault current at 12.47 kV/11.5 kV level during emergency condition I. This is not likely to impact the rating of existing interrupting devices.

Table 4-9 and Table 4-10 summarize the relay response simulations. The NEM units on H111-2 Circuit are not likely to change the existing coordination of the H110-1 and H111-2 Circuits.

The SLG and 3LG faults on H111-2 Circuit downstream R59 can be cleared by R59 at 0.200 s without and with NEM units. This means the penetration level of NEM units on H111-2 wouldn't impact the relay clearing when the faults are on H111-2 Circuit.

The NEM units on H110-1 Circuit could impact slightly the clearing time when the faults are downstream R80 or R78. This is because the fault current is very small when faults are located far away from substation.

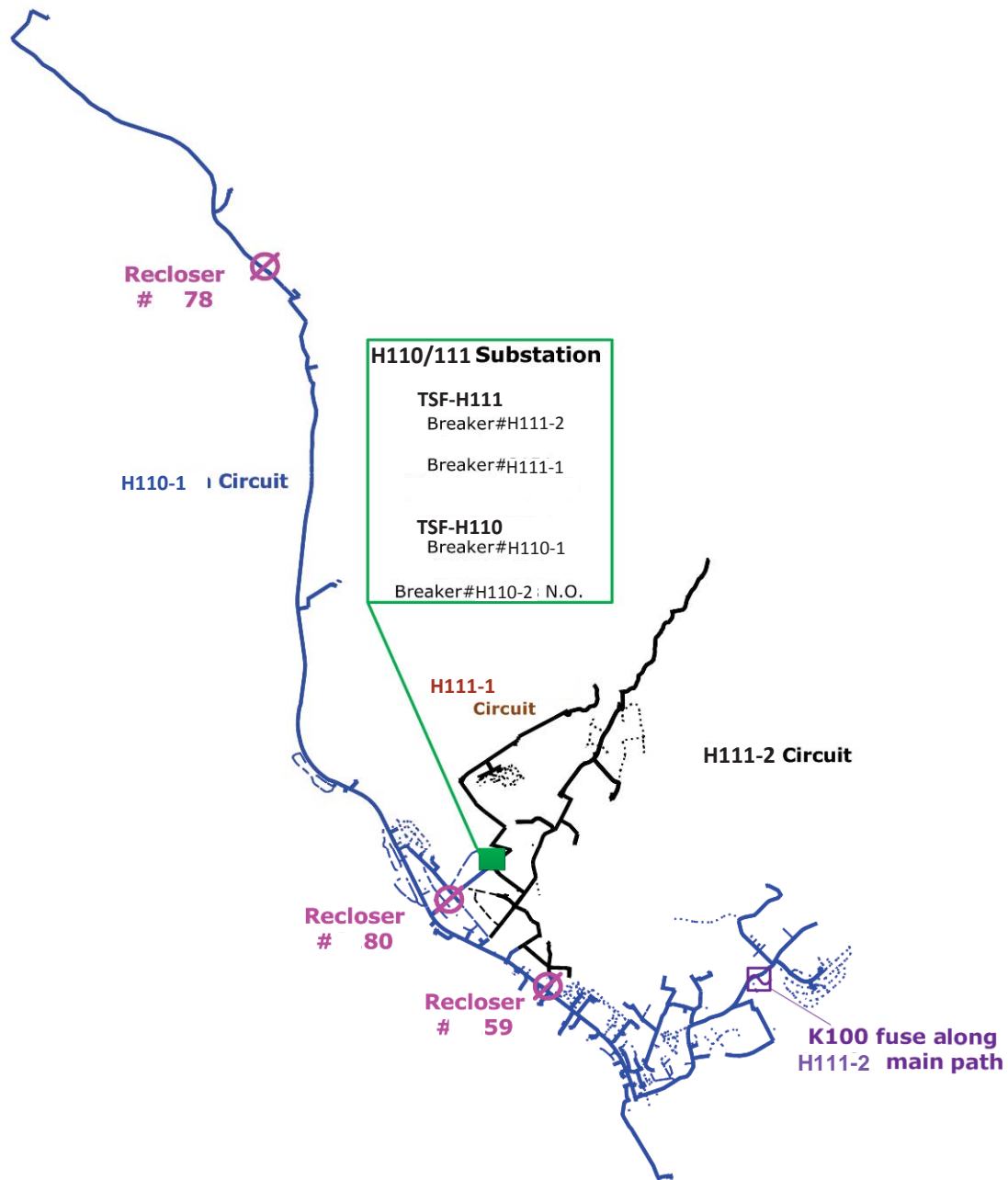

Figure 4-6: H110-1 Circuit Feeding H111-2 Circuit through Recloser 59 during Emergency Condition I

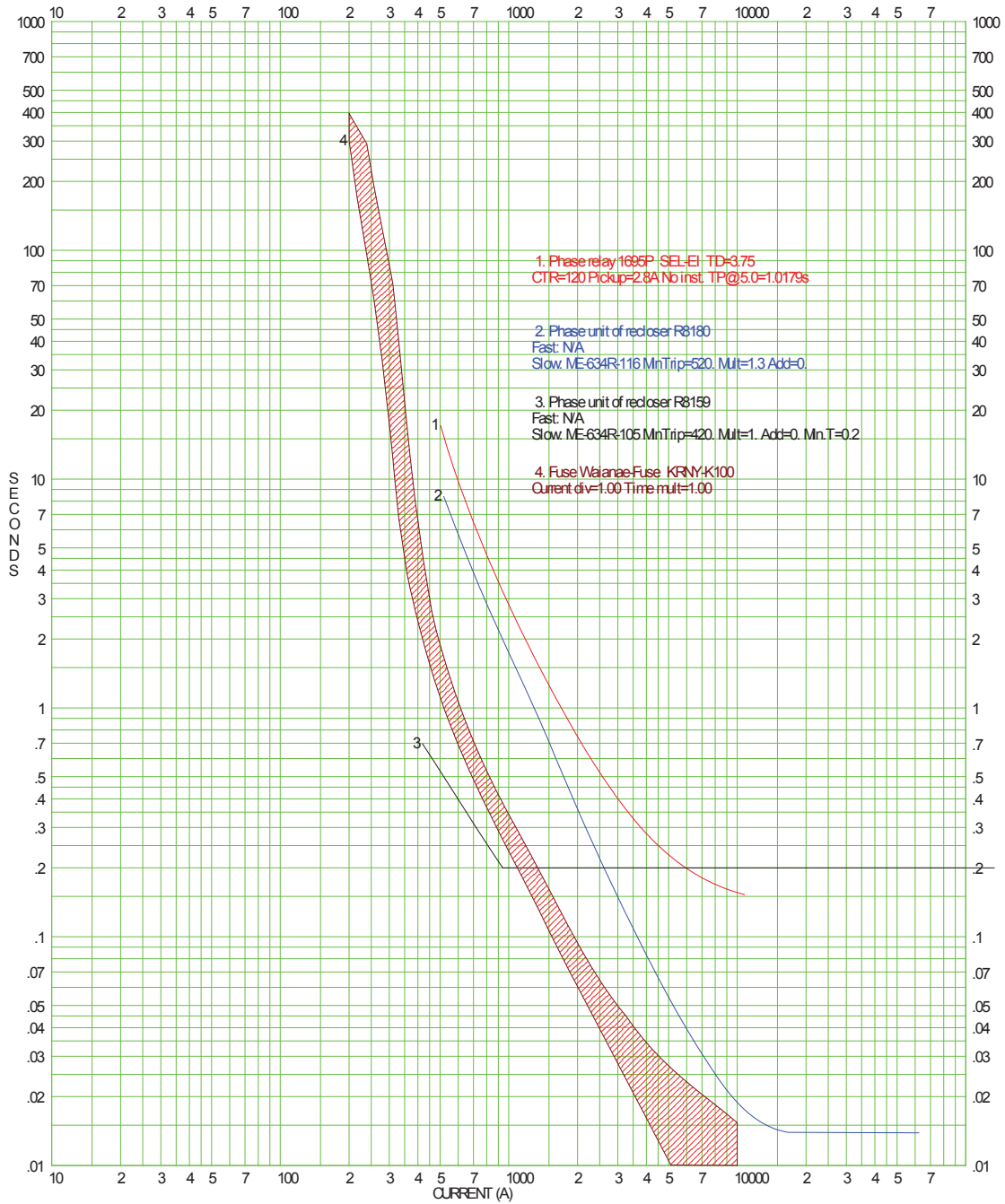

Figure 4-7: Phase Protection Coordination during Emergency Condition I

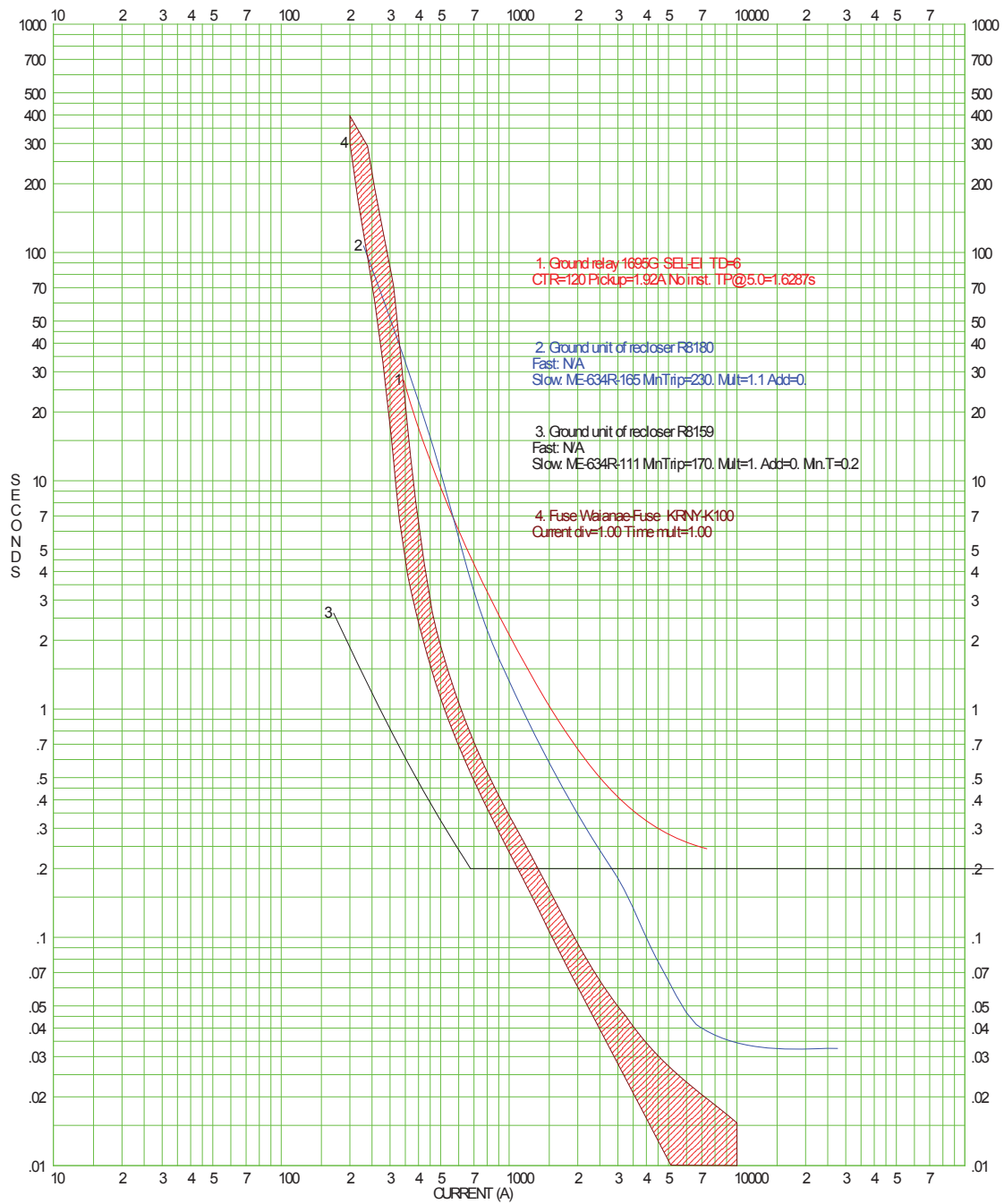

Figure 4-8: Ground Protection Coordination during Emergency Condition I

Table 4-8: Short Circuit Analysis Assuming Two Times of Rated Current during Emergency Condition I (Unit: A)

	bus	kV	SLG		3LG		NEM Contribution	
			FIT	FIT + NEM	FIT	FIT + NEM	SLG	3LG
TSF-H110	TSF-H110	46	1226	1231	1973	1996	5	23
H110-1 Circuit	MTAP1	12.47	3137	3235	2748	2846	98	98
	MTAP2	12.47	2309	2403	2313	2412	94	99
	MTAP3	11.5	904	914	1104	1122	10	18
	MTAP4	11.5	369	370	494	497	1	3
H111-2 Circuit	TAP4	12.47	1580	1679	1786	1886	99	100
	TAP5	12.47	1291	1383	1540	1632	92	92
	TAP6	12.47	1086	1167	1352	1434	81	82
	TAP7	12.47	958	1028	1231	1305	70	74
	TAP7A	12.47	931	998	1205	1277	67	72

Table 4-9: Time Response Simulation for SLG Faults during Emergency Condition I

	Fault Bus	FIT only			FIT + NEM			Time Diff (s)
		relay	current (A)	time (s)	relay	current (A)	time (s)	
H110-1 Circuit	MTAP1	BKRH110-1P	3027	0.397	BKRH110-1P	3031	0.396	-0.001
	MTAP2	R80p	2227	0.284	R80p	2227	0.284	0.000
	MTAP3	BKRH110-1G	787	3.516	BKRH110-1G	771	3.622	0.106
	MTAP4	R78G	367	17.422	R78G	368	17.211	-0.211
H111-2 Circuit	TAP4	R59G	1503	0.200	R59G	1505	0.200	0.000
	TAP5	R59G	1215	0.200	R59G	1214	0.200	0.000
	TAP6	R59G	1016	0.200	R59G	1011	0.200	0.000
	TAP7	R59G	895	0.200	R59G	888	0.200	0.000
	TAP7A	R59G	870	0.200	R59G	862	0.200	0.000

Table 4-10: Time Response Simulation for 3LG Faults during Emergency Condition I

	Fault Bus	FIT only			FIT + NEM			Time Diff (s)
		relay	current (A)	time (s)	relay	current (A)	time (s)	
H110-1 Circuit	MTAP1	BKRH110-1P	2685	0.477	BKRH110-1P	2685	0.477	0.000
	MTAP2	R80p	2220	0.274	R80p	2263	0.274	0.000
	MTAP3	BKRH110-1P	974	2.988	BKRH110-1P	954	3.112	0.124
	MTAP4	R78P	492	9.877	R78P	495	9.654	-0.223
H111-2 Circuit	TAP4	R59G	1749	0.200	R59P	1749	0.200	0.000
	TAP5	R59G	1502	0.200	R59P	1499	0.200	0.000
	TAP6	R59G	1316	0.200	R59P	1308	0.200	0.000
	TAP7	R59G	1198	0.200	R59P	1188	0.200	0.000
	TAP7A	R59G	1173	0.200	R59P	1162	0.200	0.000

4.6. Conclusions

- The existing protective devices on the study feeders at the 12.47 kV level are well coordinated.
- With a total of 4179 kW NEM units added on the study feeders, the fault current wouldn't violate the rating of the interrupting devices. With the assumption of 2 times rated current for NEM units, the maximum fault current increase is 144 A at 12.47 kV. The clearing time of the protective devices is not significantly impacted with the NEM units online. The NEM units could change the existing clearing time for about 1.5 cycles. Therefore, the study feeders are capable to accommodate the 4179 kW NEM units.
- A sensitivity study is performed which assumes a fault current as high as 7 times rated current of the NEM units. This could give a maximum of 485 A fault current contribution from the NEM units and could change the clearing time for about 3.5 cycles which is still insignificant
- During emergency condition I when part of H111-2 Circuit is fed from TSF-H110, the NEM units with total capacity of 3043 kW will not impact the existing coordination.

Section 5. Unintended Islanding

The objective of this section is to provide an overview of transient overvoltage issue related to load rejection scenarios caused by unintended islanding as well as to provide possible mitigation measures to minimize negative effects of load rejection scenarios.

5.1. Overview on Overvoltage Due to Load Rejection

Load rejection, resulted from tripping of interrupting devices, causes isolation of online PV units and has the potential to lead to transient overvoltage (TOV). This risk is mitigated by the amount of customer resistive load that is isolated with the PV units as feeder loads tend to dampen the magnitude of overvoltage. Load rejection overvoltage is generally a concern for customers' equipment insulation and surge arresters when the total isolated generation is much greater than the total isolated load.

5.2. Methodology and Assumptions

During the time of the study, PSCAD model for single phase PV unit was not available from any manufacturers. Hawaiian Electric and Pterra were able to gather some load rejection test data from a manufacturer. The test was limited to load rejection with one load event and limited to a specific inverter. In order to understand the impact of single phase PV units related to a variety of load scenarios, Hawaiian Electric and Pterra decided to build two single-phase PV PSCAD models:

- A single-phase voltage source converter (VSC) where V_{dc} depends on AC voltage from the grid ("Model A"). V_{dc} is controlled through the bridge and DC converter controls power flowing to DC link (i.e. maximum power point tracking, or MPPT). This operation mode is modeled in our study with constant current source on DC side. This model is applicable to most commercial PV units.
- A single-phase voltage source converter (VSC) where V_{dc} is constant ("Model B").

After discussion with Hawaiian Electric, it was decided that the simulations were performed using simplified model as in Figure 5-1. The model uses a 10 kW inverter (Model A or Model B) and a constant-impedance load with unity power factor; the grid is modeled using a constant voltage source. The inverter output is maintained constant at 10 kW while the load is adjusted from 0 to 10 kW. This approach was done because the simplified model will still capture the impact of load rejection overvoltage on the circuit. Modelling all single phase PV units would not be practical; it was found that the time required and costs involved were prohibitive to continue with this strategy.

Here are some assumptions made in the model:

- The Vdc is set at 110% of Vac peak nominal. For example, for 240 Vac inverter, the Vdc is set about 373 V. Increasing Vdc setting will increase the TOV magnitude.
- The model is set to trip whenever Vdc reach about 150%. For conservatism, no other tripping scheme was implemented in the model. In a real converter, there may be voltage and current hard limits to protect the switching devices as well as control scheme to detect the inverter controller's misbehavior.

5.3. Single Phase PV PSCAD Model

Figure 5-1 shows a block diagram of 10 kW single-phase Voltage Source Converter (VSC) modeled in PSCAD. The model consists of:

- Controllable DC voltage or current source (depending on mode of operation) at DC side
- Full bridge single phase inverter
- Passive harmonic filter
- Single-phase Phase-Lock-Loop (PLL) and control unit
- An ideal voltage source representing the grid

Two modes of operation may be considered for the model:

- 1) "Model A": Vdc is controlled through the bridge and DC converter controls power flowing to DC link (i.e. maximum power point tracking (MPPT)). This operation mode is modeled in our study with constant current source on DC side.
- 2) "Model B": Vdc is controlled using DC/DC converter on DC side. The bridge is controlled to deliver power to the AC side. This operation mode is modeled in our study with constant voltage on DC link.

It is assumed that the model has a protection controller which trips DC converter and block firing signals provided that DC link voltage exceed the limit (i.e. 150% of set point). Set point of Vdc is considered to 110% of nominal peak voltage. Besides DC protection controller, no protection unit is modeled.

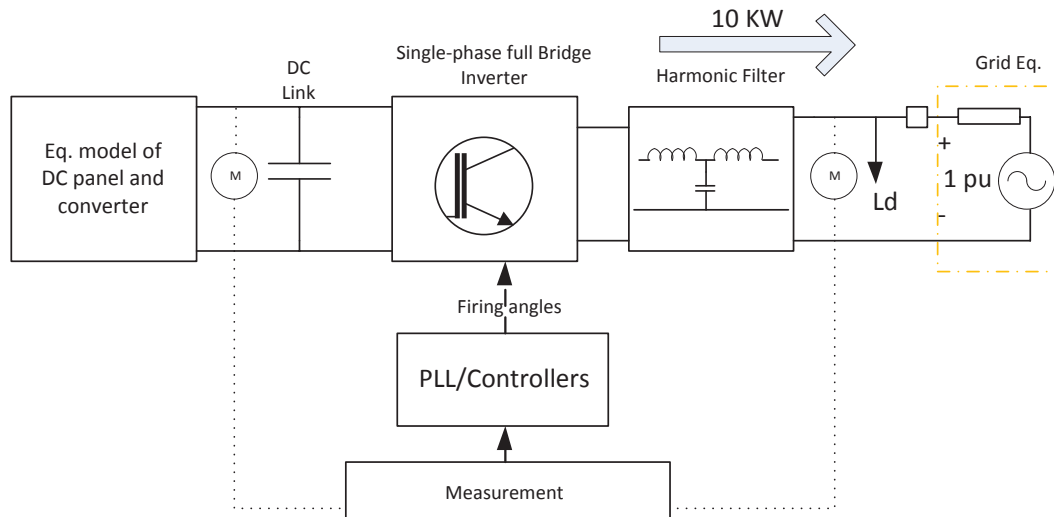

Figure 5-1: Block Diagram of Modeled Single phase Inverter with Load and Grid Equivalent

5.4. Criteria

Hawaiian Electric proposes to use ITIC (Information Technology Industry Council) curve for the criteria as in Figure 5-2. The ITIC curve is a new version/revision from CBEMA (Computer Business Equipment Manufacturers Association) curve. For example, for a maximum TOV magnitude of about 162%, the inverter should trip - within 0.15 cycles in order to be within acceptable level of the ITIC curve. If inverter fails to trip within the time frame, there is potential damage to sensitive customer loads.

Hawaiian Electric decided to use ITIC curve because it is applicable on customer 120 V nominal voltage where the NEM PV units would be located.

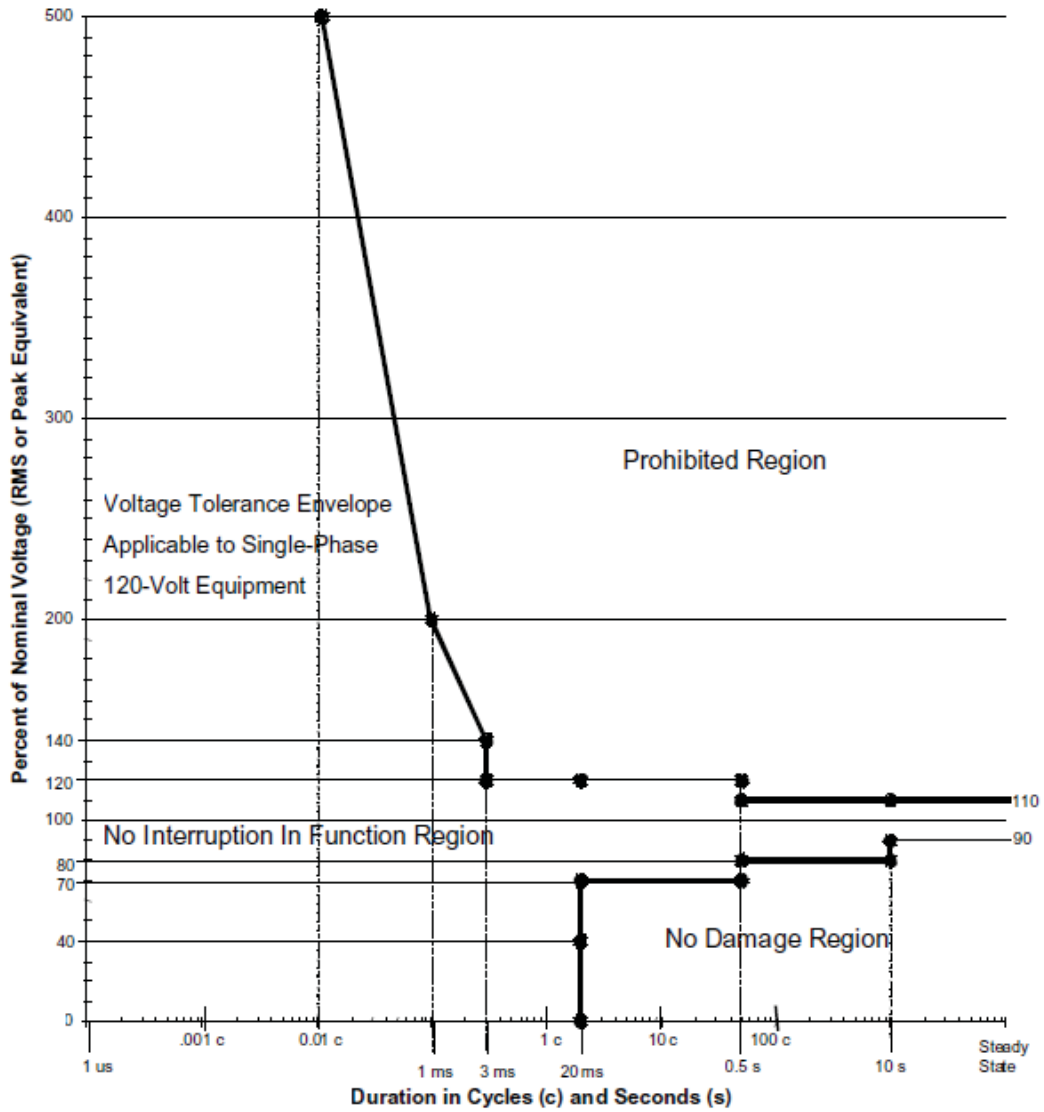

Figure 5-2: ITC (CBEMA) Curve, Revised 2000

5.5. Analysis Results

Simulations were performed using a 10 kW inverter (Model A) and a constant impedance load with unity power factor. The inverter output is maintained constant at 10 kW while the load is adjusted from 0 to 10 kW as in Table 5-1. The simulation is run for 1.5 seconds and then the feeder breaker is opened isolating the generation and the load from the grid. The simulation is stopped at 4 seconds. The per-unit voltage waveform and maximum magnitude of transient overvoltage are reported to illustrate the impact of TOV for the simulated scenarios.

Table 5-1: Results Summary of TOV Magnitude with A Variety of Load/Generator Ratios

Scenario	Load/Generator Ratio	TOV Magnitude (%)
A	0%	162
B	10%	162
C	30%	144
D	50%	123
E	70%	119
F	90%	110
G	100%	108

Based on Table 5-1, the maximum magnitude for TOV is about 162% when the inverter is disconnected from the circuit with no load. The plot for Scenario A is shown in Figure 5-3.

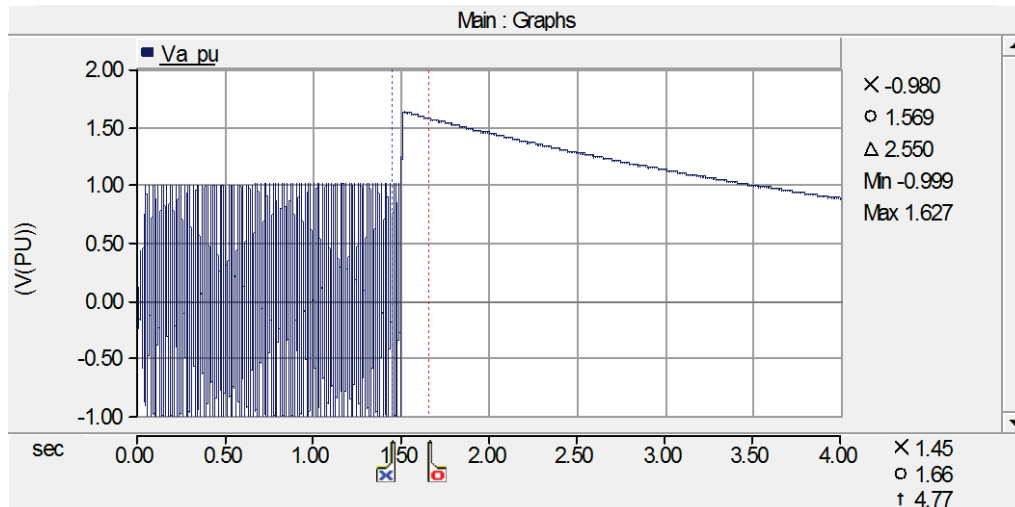
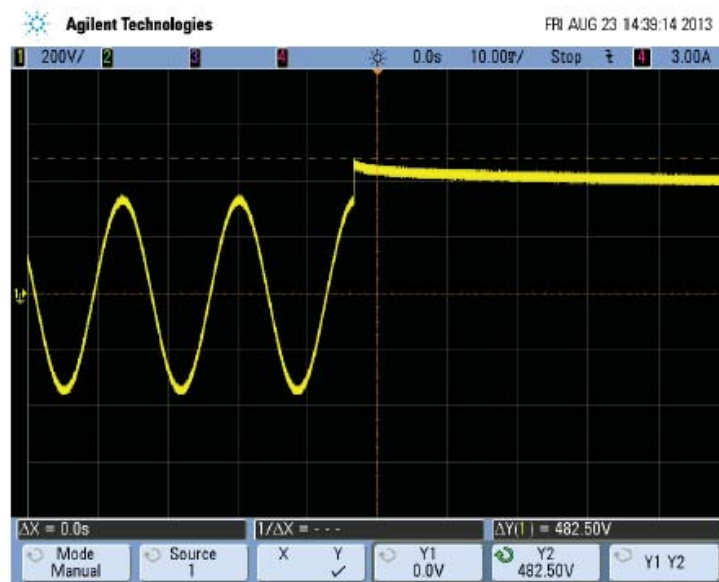

Figure 5-3: Line to Neutral Voltage (P.U.) for Scenario A (Load/Generator ratio of 0%)

Figure 5-4 shows a response from a manufacturer test with similar scenario as in Scenario A. Comparing Figure 5-3 and Figure 5-4, it shows that Model A and the manufacturer test match very well. The manufacturer test shows a maximum TOV magnitude of about 160%. Please note inverter trips in both Figure 5-3 (PSCAD Model A) and Figure 5-4 (manufacturer test) in less than 0.1 cycles. There is non-sinusoidal waveform (dc decay) after the inverter trips which can be explained by slow discharge of filter's capacitor due to the absence of load on the circuit. With an increase of the load to about 10% (1 kW), the dc decay is no longer exist as in Figure 5-5.

Fast



Slow

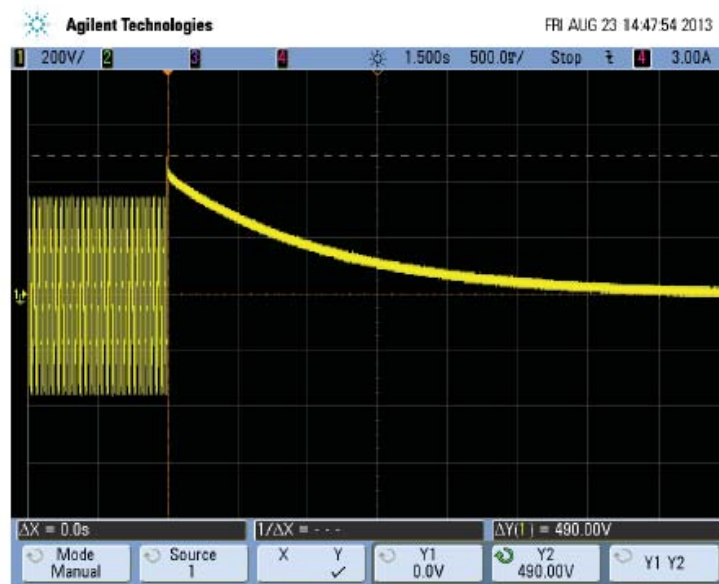

Figure 5-4: Manufacturer Load Rejection Test with Load/Generation of 0% (Provided by Hawaiian Electric)

Figure 5-5 through Figure 5-10 show voltage waveform with different load levels (Scenario B through Scenario G). Figure 5-5 (Scenario B) shows TOV magnitude of about 162%, the inverter trips less than 0.1 cycles triggered by Vdc trip setting of about 150%. Figure 5-6 (Scenario C) through Figure 5-10 (Scenario G) show that the maximum TOV overvoltage does not reach the Vdc trip setting and the inverter does not trip because no protection scheme other than Vdc trip setting is modeled. In a real inverter, however, there would be voltage and current hard limits to protect the switching devices as well as control scheme to detect the inverter controller's misbehavior.

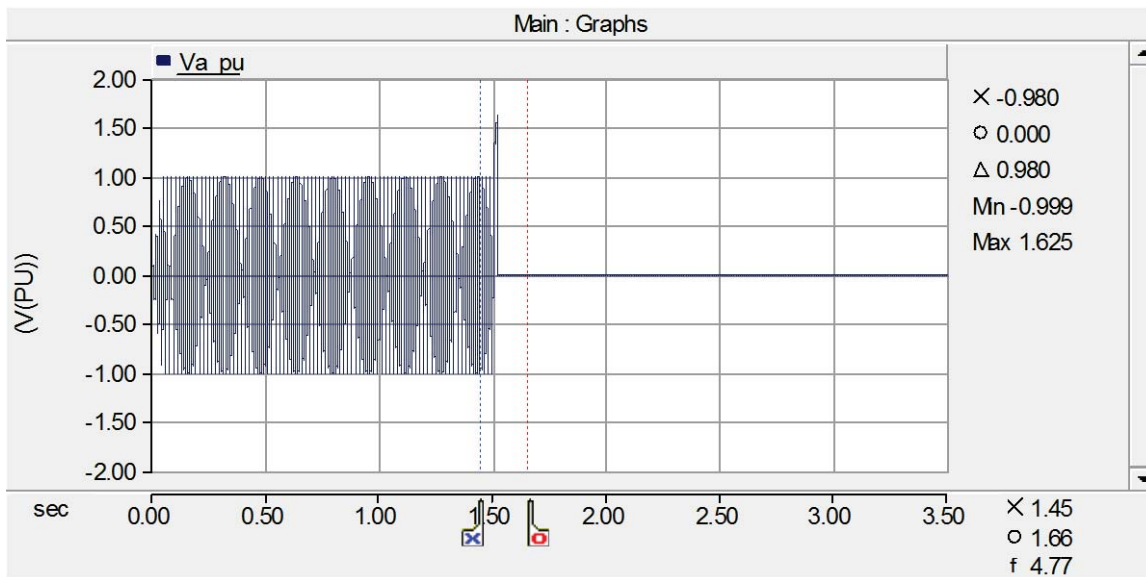

Figure 5-5: Line to Neutral Voltage (P.U.) for Scenario B (Load/Generator Ratio of 10%)

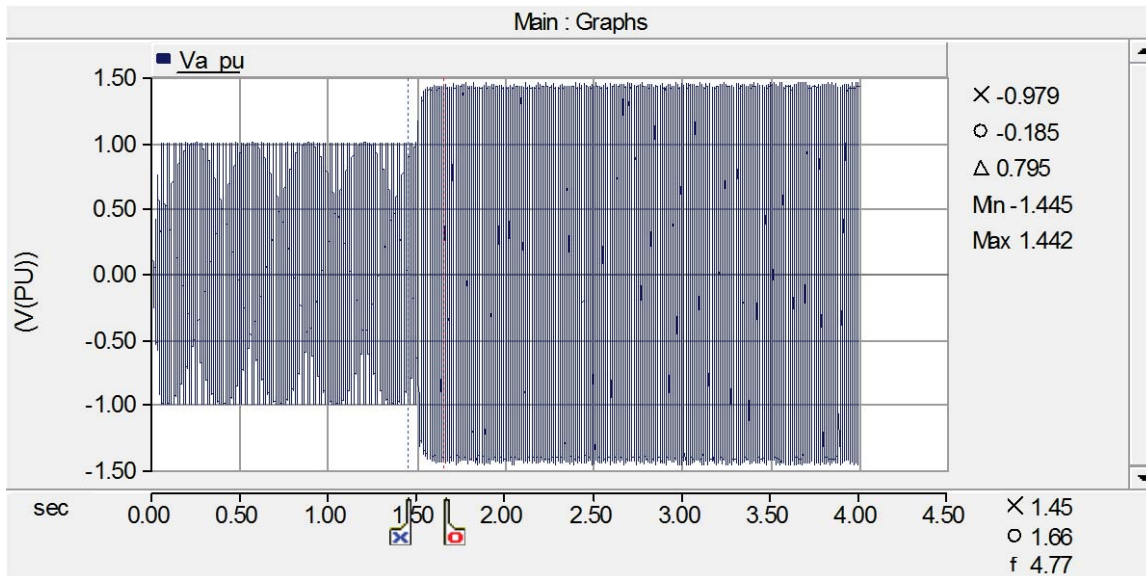

Figure 5-6: Line to Neutral Voltage (P.U.) for Scenario C (Load/Generator Ratio of 30%)

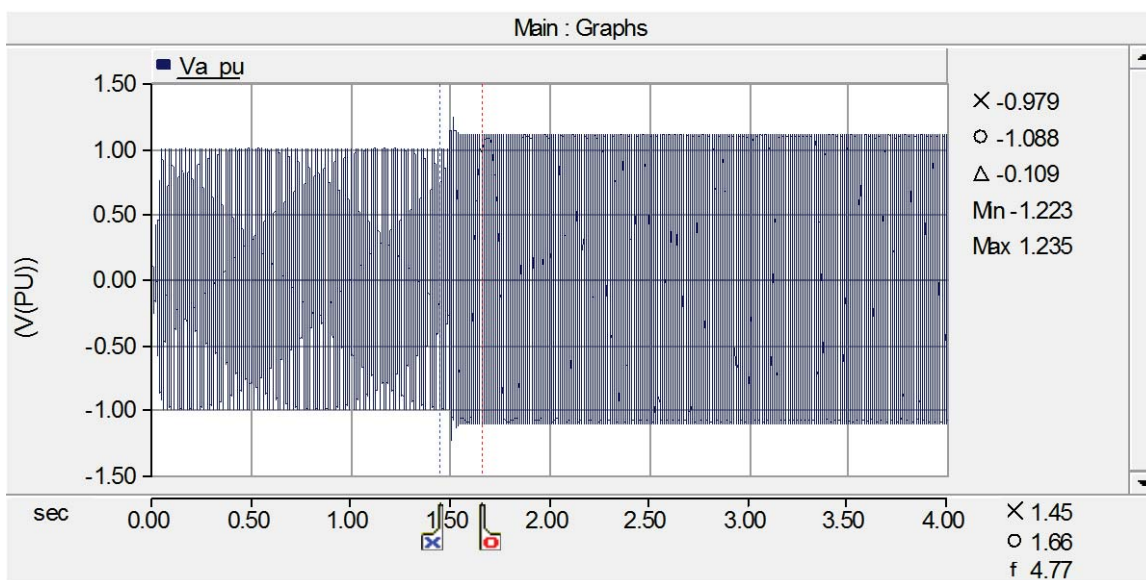

Figure 5-7: Line to Neutral Voltage (P.U.) for Scenario D (Load/Generator Ratio of 50%)

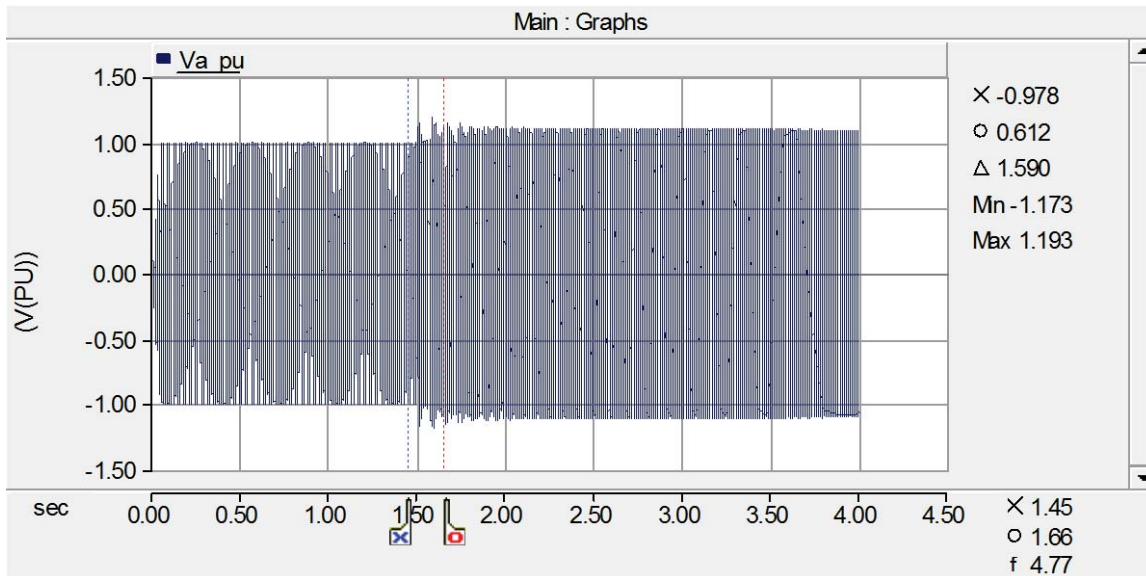

Figure 5-8: Line to Neutral Voltage (P.U.) for Scenario E (Load/Generator Ratio of 70%)

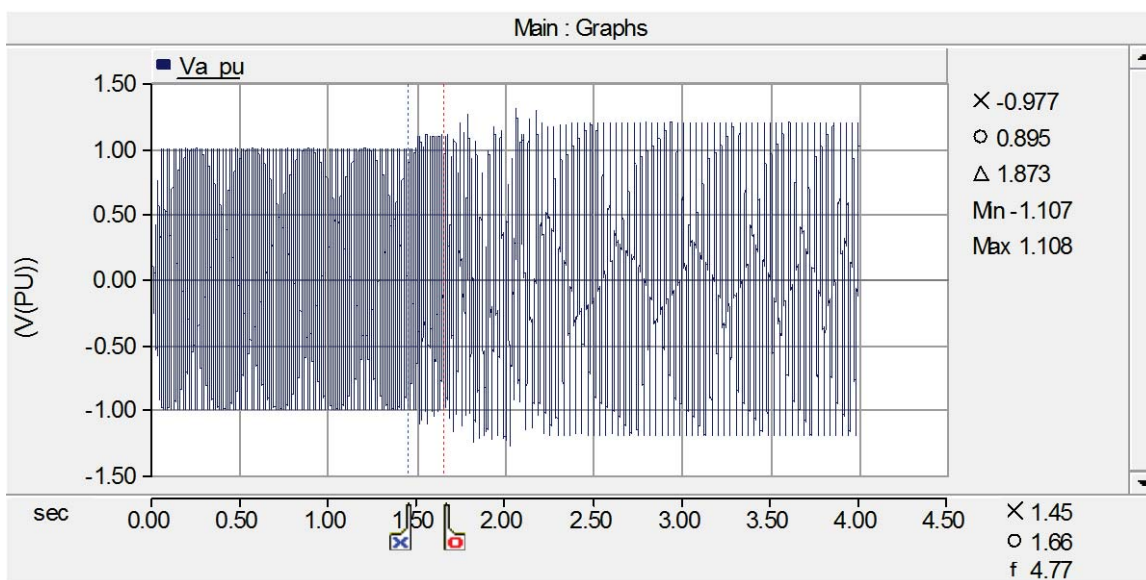

Figure 5-9: Line to Neutral Voltage (P.U.) for Scenario F (Load/Generator Ratio of 90%)

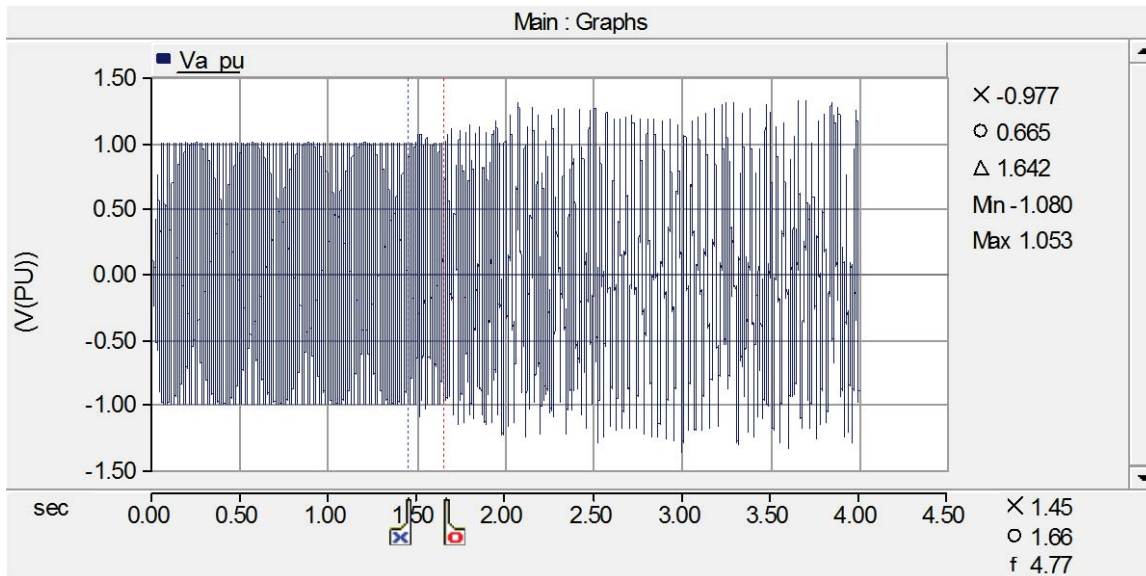

Figure 5-10: Line to Neutral Voltage (P.U.) for Scenario G (Load/Generator Ratio of 100%)

For Inverter Model B, as expected, the simulation shows that the model will not cause severe TOV because the DC voltage does not depend on grid voltage but rather is controlled by DC/DC converter on DC side. Figure 5-11 shows load rejection simulation plot for a 10 kW inverter (Model B) isolated from the grid with no load (load/generation ratio of 0%). The maximum TOV is about 110% versus 162% shown in Model A.

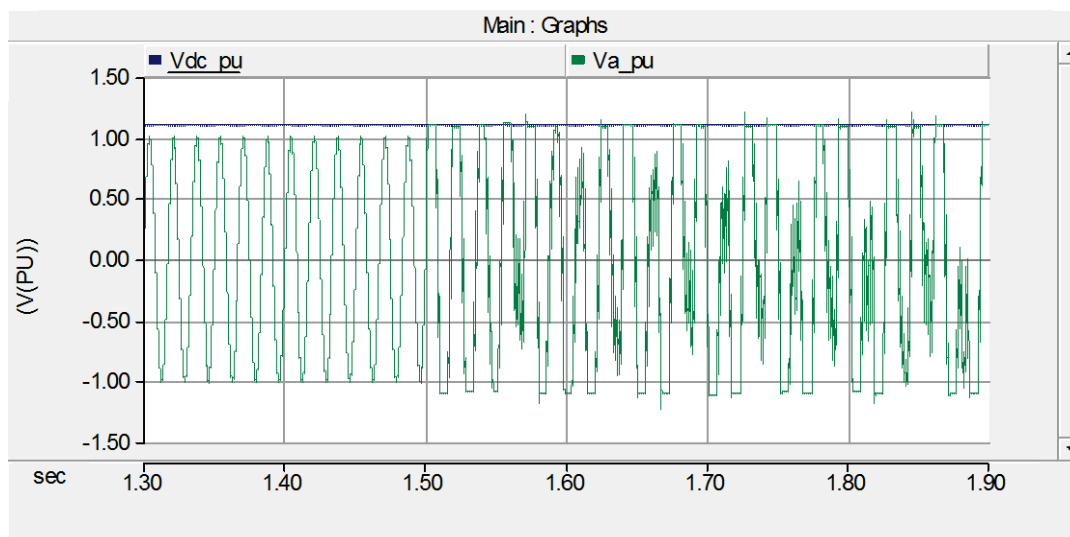

Figure 5-11: Line to Neutral Voltage (P.U.) for Model B (Load/Generator Ratio of 0%)

5.6. Mitigation

From simulations of single phase inverter with different levels of loading, the maximum TOV magnitude could be about 162%. The inverter should trip within 0.15 cycles in order to be within the acceptable level of the ITIC curve. If inverter fails to trip within the time frame, there is potential damage to sensitive customer loads. Here are several options to mitigate potential damage to sensitive customer loads:

Mitigation on Inverter Unit

- In addition to the overvoltage setting required by IEEE 1547, an additional high overvoltage setting with a very fast trip should be applied to single phase inverters (third stage setting). This setting should be set about 140 – 150% of nominal peak voltage and should use instantaneous detection instead of RMS detection. The 140-150% would cause less potential nuisance trip due to switching events and instantaneous detection would allow faster response (less than a cycle).
- Software Protection. Shorten the overvoltage duration through software/firmware modifications for existing inverters that are already installed on the circuit. For example a manufacturer was able to shorten the TOV from 3 cycles to about 0.5 cycles⁹ and then surge suppressor can be used to clamp the rest of overvoltage¹⁰. It is expected that this approach can significantly reduce the risk to the electric devices. This approach can be implemented for existing PV units on the circuit.
- Utilize MOV (Metal-Oxide Surge Arresters) near the inverter. Detailed discussion is provided in Section 5.7.

Adjust the Protection to Avoid Islanding Event

9 R. J. Bravo, R. Yinger, S. Robles and W. Tamae "Solar PV Inverter Testing for Model Validation", Power and Energy Society General Meeting, 2011 IEEE, 24-29 July 2011, San Diego, CA, pp 1 - 7

10 F. J. Pazos, E. Navarro, "Field experience of Power Frequency Overvoltages in Wide-Scale Photovoltaic Systems", Integration of Wide-Scale Renewable Resources Into the Power Delivery System, 2009 CIGRE/IEEE PES Joint Symposium, 29-31 July 2009, pp 1

- Disable the fast curves of the phase and ground sensor of the recloser to reduce exposure to transient overvoltages. A fault that leads to islanding of the feeder with the DG remaining online could cause TOV on the feeder. Disabling the fast curves allows the DG to trip ahead of recloser such that, if and when, islanding occurs, the DG will already be offline. The fast curves are generally used in fuse saving scheme.
- Disable instantaneous overcurrent function on the substation breaker. Similar to the above discussion, disabling the instantaneous element allows the DG to trip ahead of the substation breaker and therefore would reduce islanding event. The instantaneous is generally enabled for fuse saving scheme.

Note that the H111-2 and H110-1 circuits do not have instantaneous overcurrent function on the substation breaker and do not have recloser fast curves.

Modify the Operation

- Monitor the reverse power flow on the feeder substation. If major reverse power flow occurs then some PV units could be curtailed. In this case, strategy similar to demand response could be used; for example, by giving incentive to curtailed PV units. This in turn could avoid expensive mitigation cost.
- Reconfigure the circuit in such a way that most of the load could be retained when islanding event occurs. This could be done by relocation of recloser or other interrupting devices.

Battery Storage

- Battery storage could be used to increase the loading level during noon time when the PV units generates near their full capacity by charging the battery during day time and discharging it during night-time when PV units do not generate.

5.7. TOV Mitigation with MOV¹¹

Although inverter manufacturers suggest that the single phase inverter could trip less than a cycle after detecting the overvoltage or stop exporting power, the utility generally wants to have a back-up overvoltage protection in case the inverter fails to trip.

¹¹ This section is provided by ArresterWorks

Another option is to use a MOV rated at 300V rms L-L and 150VL-N. Pterra has proposed that an efficient and effective way to deal with a short duration power frequency overvoltage surge event is to mitigate the surge before it enters the utility and home, by using a properly sized MOV on each inverter installation. This section discusses this concept. In addition to temporary and transient overvoltage protection, the MOV also protects the equipment from lightning and switching transient.

5.7.1. MOV Fundamentals

An MOV device (arrester) can be viewed as a voltage sensitive semi-conductive switch. The arrester's VI curve shows the relationship of the voltage and current under all potential voltage. Figure 5-12 shows the VI curve of a 150V MOV arrester. The curve is a combination of DC, AC and Impulse characteristics of the material. The curve is useful in that it clearly shows the voltage levels necessary to produce current flow through the unit. Area A on the curve is referred to as the operating region, Area B the turn on region, Area C the TOV region and Area D the impulse region. If an arrester is subjected to a rise in a power frequency voltage across its terminals, the current will rise instantaneously along with it. If the voltage reaches a level that pushes it into Area C, the current through the MOV can become substantial.

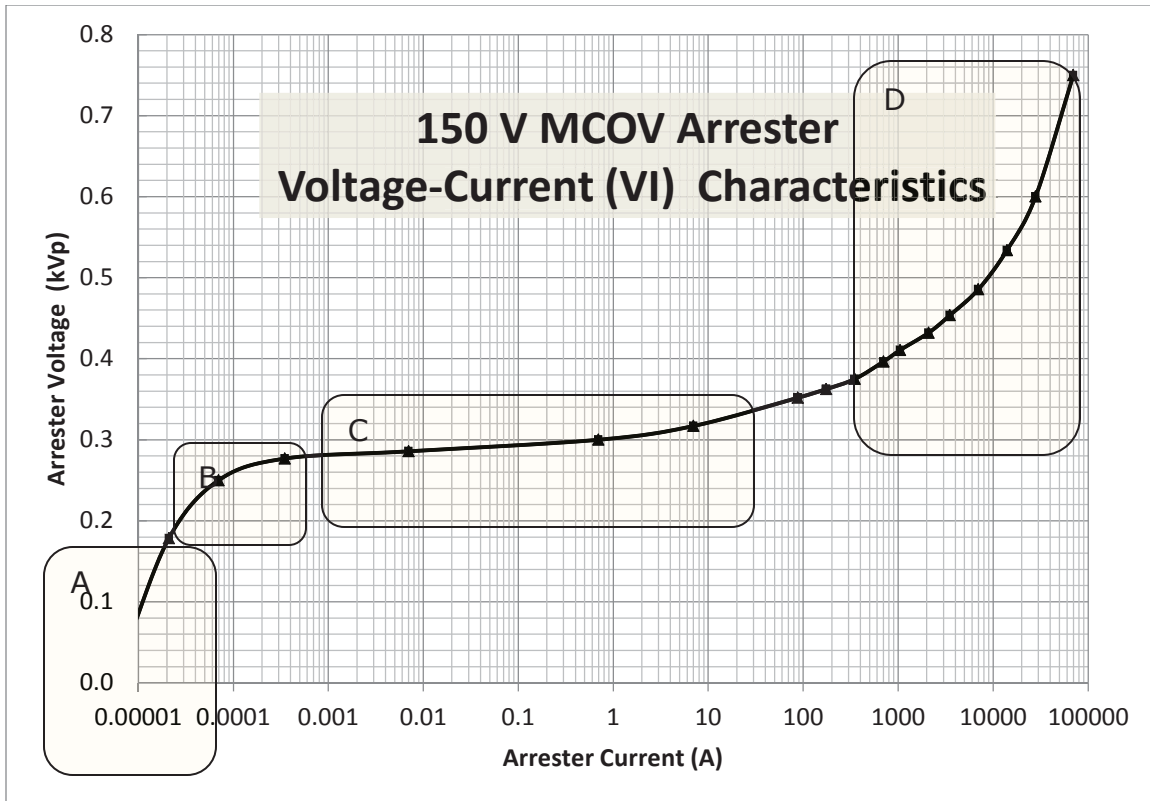

Figure 5-12: Voltage-Current VI Characteristic of MOV Arrester

When a TOV occurs in an MOV, the current through the device can be from 1 mA to 100 A. At all these current levels, the MOV temperature will rise because it cannot dissipate heat fast enough naturally to maintain a constant temperature. If the voltage is maintained long enough or is high enough, a failure will occur. This type of failure is called a thermal runaway or TOV failure.

5.7.2. Failure Mode

When an arrester or MOV suffers a TOV type failure the current flowing through the material finds a preferential path where the resistance of the disk is the lowest and burns a hole along this path. Figure 5-13 shows a TOV failure path through a high voltage disk. The conductivity of the material along the hole is very low and no longer has varistor characteristics. Along the failure path, it has become a low Ohmic resistor. The material does not fail in the open mode naturally; it fails in a short circuit mode in all cases. If there is significant energy in the failure event, gases can be created that expand rapidly resulting in a fragmented disk, which in some cases can then look like an open circuit. This open circuit failure only occurs if the MOV material or disk is not contained and held together by the housing of the arrester.



Figure 5-13: TOV Type Disk Failure Where a Preferential Path Failure Occurred (Arresterworks)

5.7.3. TOV Curve

To assist arrester users, IEEE C62.11 requires that the Temporary Overvoltage Characteristic of arresters be measured and published. The TOV characteristic defines the time voltage relationships that can lead to an arrester failure of this type. Figure 5-14 is the TOV curve for the 175V MCOV Cooper Stormtrapper HE. The curve indicates that this particular arrester can withstand a PU overvoltage of 1.48 MCOV for a duration of .1 seconds without failure or in other words if a 1.48pu (259 volts) overvoltage across the terminals of the arrester exceeds .1 seconds, that it will fail. If the overvoltage is less than .1 seconds it will recover from the short heating event and continue to protect.

If a 150V MCOV arrester were used for this application and had the VI curve as shown in Figure 5-12 and the TOV curve as shown in Figure 5-13, then the maximum voltage that would appear on the line during a fault would be 330 V peak (from Figure 5-12, the max Voltage for this arrester in area C) x .707 equals 233 V rms. This is about 2.1PU.

If the PV could produce enough current to push the MOV to this current level, it would survive perhaps one cycle before failing. The actual TOV curve of the MOV used would be needed to make the complete evaluation. *If the MOV was designed so that it did not blow apart or does not have a series fuse, then it would fail short and clamp the voltage very near to zero after it failed.*

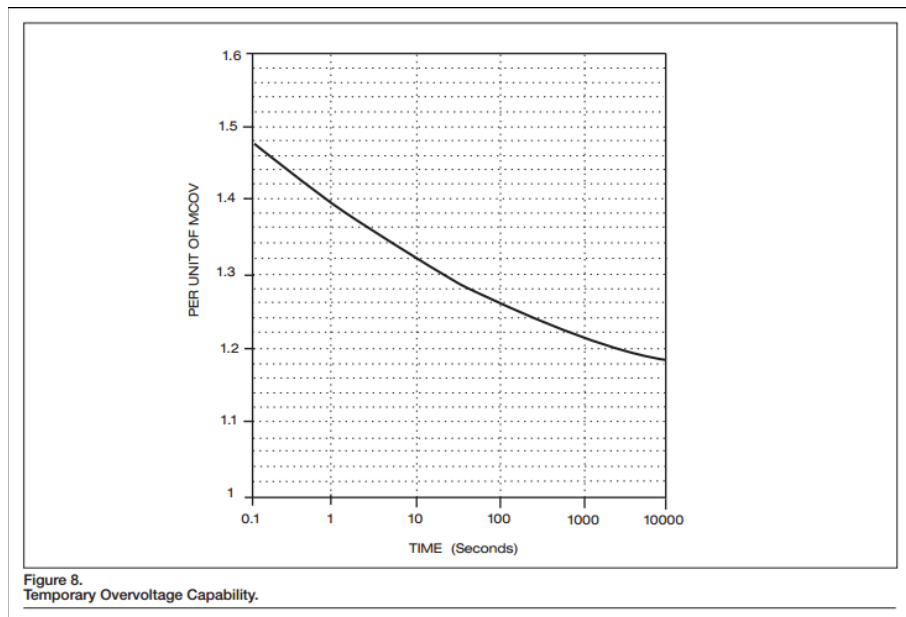

Figure 5-14: TOV Curve of StormTrapper HE

5.7.4. Lower Rated MOV

If a 130V MCOV arrester is used it can clamp the TOV to a 20% lower level but would be subject to premature failures if the line voltage increased only 10%.

130Volt RMS VI Characteristics	
Current (A)	kV peak
0.000007	0.031
0.000021	0.155
0.00007	0.217
0.00035	0.240
0.007	0.248
0.7	0.260
7	0.275
87.5	0.305
175	0.314
350	0.325
700	0.344
1050	0.356

150Volt RMS VI Characteristics	
Current (A)	kV peak
0.000007	0.036
0.000021	0.179
0.00007	0.250
0.00035	0.277
0.007	0.286
0.7	0.300
7	0.317
87.5	0.352
175	0.363
350	0.375
700	0.396
1050	0.411

5.7.5. Installation Considerations

Most low voltage MOV arresters are mountable in a panel, or hanging from the residential mast, or mounted on a structure. The example below is from Cooper Power Systems and is enclosed in a failsafe grounded box. The box has a window in the side so that a failed unit can be easily identified. This device is part of the [Stormtrapper HE family of arresters](#). At the moment Cooper (Now Eaton) only makes this arrester in a 175V and higher rating. This of course may be changeable to 150V as discussed in this section. The cost of this device is well under 200 USD.



5.7.6. Summary of TOV Mitigation with MOV

1. A 150 Volt MCOV rated low voltage arrester can be used to mitigate a TOV on a 120Volt PV system. Depending on the design, the arrester may or may not fail during a mitigation event. If it fails it will fail short if it is designed to do so. If the MOV was designed so that it did not blow apart or does not have a series fuse, then it would fail short and clamp the voltage very near to zero after it failed.
2. This type of arrester can be mounted indoors or outdoors. If a Stormtrapper HE is used, it will fail with a grounded housing for safety.

5.8. Conclusions

- Pterra and PSCAD Consulting were able to create a PSCAD model for single phase PV that closely match manufacturer load rejection test. The model was then used to test different scenarios.
- From transient simulations of single phase inverter with different level of loading, the maximum TOV magnitude could be as high as 162%. The inverter should trip within 0.15 cycles in order to be within acceptable level of the ITIC curve. Although some inverter manufacturers claim to be able to trip within less than 0.1 cycles or no delay, this claim may need to be independently verified. Similarly, another manufacturer mentioned that its PV inverter has the ability to stop exporting power when a voltage transient is detected; Hawaiian Electric may need to verify this capability.
- Some mitigation measures are proposed as mentioned in Section 5.6

H47-2 REPRESENTATIVE HIGH-PENETRATION PHOTO-VOLTAIC CIRCUIT STUDY

The goal of this study is to identify the risk and/or limitation of accepting more NEM (primarily small roof top solar) interconnections onto the H47-2 circuit. Further, this study is intended to produce results which can be applied to similar feeders throughout Hawaiian Electric Company system.

UC / SYNERGETIC



H47-2 Representative High-Penetration Photo-Voltaic Circuit Study

Contents

Executive Summary.....	8
Overall Levels of Concern for HPPV on Distribution Feeders	10
Results.....	10
Introduction	12
Definitions.....	14
Categories and Priority of Issues/Concerns with HPPV	17
Steady State Study	18
Criticality	19
Likelihood of Occurrence or Problems Related To:	19
H47-2 Original Load-Flow Model	19
H47-2 Study Load-Flow Model.....	19
Things to Note about the Model.....	20
Study Methodology.....	21
Stage 1: Model Validation.....	23
Stage 1 Summary	25
Stage 2: NEMs Evaluation	26
Stage 2 Summary	26



 Hawaiian Electric	<i>H47-2 Representative High-Penetration Photo-Voltaic Circuit Study</i>
--	--

Stage 3: NEMs with FITs Evaluation 27

Stage 3 Summary 27

Implications to H47-2 27

Application to other feeders 28

Protection 28

 Criticality 28

 Likelihood of Occurrence or Problems Related To: 28

 Protection Review 28

 Implications to H47-2 30

 Application to other feeders 31

Flicker 31

 Criticality 31

 Likelihood of Occurrence or Problems Related To: 31

 Flicker Review 31

 Recommendation for Flicker mitigation 34

 Implications to H47-2 34

 Application to other feeders 34

Temporary Overvoltage (TOV) 34

 Criticality 34

 Likelihood of Occurrence or Problems Related To: 35

 TOV Review 35

 UC SYNERGETIC <i>Innovative Thinking. Engineered Solutions.</i>	Filename: H47-2_Final.Docx Modified: 2/25/14 Page: 2 of 113
---	---

 Hawaiian Electric	<i>H47-2 Representative High-Penetration Photo-Voltaic Circuit Study</i>
--	--

Causes of TOV related to PV generation..... 35

Eliminating or mitigating TOV 38

Recommendation for TOV mitigation..... 39

Implications to H47-2..... 39

Application to other feeders..... 39

Unintended Islands 40

 Criticality 40

 Likelihood of Occurrence or Problems Related To: 40

 Unintended Island Review 40

 Implications to H47-2..... 41

 Application to other feeders..... 41

Harmonics 41

 Criticality 41

 Likelihood of Occurrence or Problems Related To: 41

 Harmonic Review 41

 Implications to H47-2..... 47

 Application to other feeders..... 47

LPV Plot Study 48

 LPV Plots..... 48

 Unintended Islands 48

 Ground-fault Overvoltage (TOV)..... 48

 Hawaiian Electric	<i>H47-2 Representative High-Penetration Photo-Voltaic Circuit Study</i>
--	--

Load Rejection TOV	49
Reverse Overload (thermal capacity limit)	49
Voltage Regulation.....	49
Implications to H47-2.....	49
Application to other feeders.....	51
LPV Plot Findings for the H47-2 Circuit.....	52
LPV Plot Findings Generalized for the Hawaiian Electric Company System	52
Summary and Recommendations.....	53
Factors that limit PV penetration.....	54
Limitations on PV Penetration	55
Overall Levels of Concern for HPPV on Distribution Feeders	56
Bibliography	56
Appendix A – Recommendations for Further Investigation	59
Appendix B – Load to Generation (LPV) Plots.....	61
Load Curve	61
Solar Curve	62
Load and Solar Profiles.....	63
LPV Plot.....	63
Unintended Islands (Islanding)	64
Load-Generation Box	66
Ground Fault Overvoltage.....	68

 Hawaiian Electric	<i>H47-2 Representative High-Penetration Photo-Voltaic Circuit Study</i>
--	--

Reverse Overload.....	69
Risk of the Occurrence of an Event.....	70
Example.....	71
Appendix C – LPV Findings	74
H47-2.....	75
Appendix D – Load-Flow Results.....	80
Stage 2: NEMs study Voltage	80
H47-2 Day Minimum Load Case	80
H47-2 Peak Load Case	81
H47-2 High Load Case	82
Stage 2: NEMs study kW	82
H47-2 Day Minimum Load Case	82
H47-2 Peak Load Case	84
H47-2 High Load Case	85
Stage 2: NEMs study kvar.....	86
H47-2 Day Minimum Load Case	86
H47-2 Peak Load Case	87
H47-2 High Load Case	88
Stage 3: NEMs study	89
Voltage - FITs @ 99 pf Consuming	89
H47-2 Day Minimum Load Case	89

 Hawaiian Electric	<i>H47-2 Representative High-Penetration Photo-Voltaic Circuit Study</i>
--	--

H47-2 Peak Load Case 90

H47-2 High Load Case 91

KW - FITs @ 99 pf Consuming 92

H47-2 Day Minimum Load Case 92

H47-2 Peak Load Case 93

H47-2 High Load Case 94

kvar - FITs @ 99 pf Consuming 95

H47-2 Day Minimum Load Case 95

H47-2 Peak Load Case 96

H47-2 High Load Case 97

Voltage - FITs @ 95 pf Producing vars 98

H47-2 Day Minimum Load Case 98

H47-2 High Load Case 100

KW - FITs @ 95 pf Producing vars 101

H47-2 Day Minimum Load Case 101

H47-2 Peak Load Case 101

H47-2 High Load Case 103

kvar - FITs @ 95 pf Producing vars 104

H47-2 Day Minimum Load Case 104

H47-2 Peak Load Case 105

H47-2 High Load Case 106

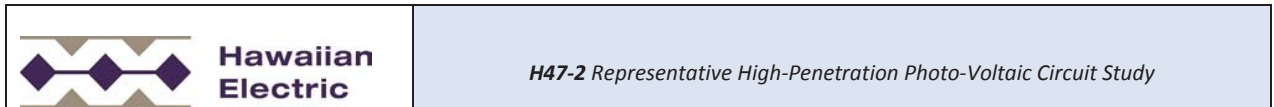

Appendix E – More on Flicker 108

Appendix F – Voltage Rise..... 110

Legal Notice:

This report was prepared by UC Synergetic, LLC (UCS) as an account of work undertaken under the authorization of Hawaiian Electric Company.

UCS does not:

1. Make any warranty or representation, expressed or implied, with respect to the use of any information contained in this report, or that the use of any information, apparatus, method, or process disclosed in the report may not infringe privately owned rights.
2. Assume any liabilities with respect to the use of or for damage resulting from the use of any information, apparatus, method, or process disclosed in this report.

The report is confidential and proprietary to UCS and Hawaiian Electric Company and may not be copied, duplicated, or loaned or transferred to a non-designated party without the express written permission of UCS and Hawaiian Electric Company.

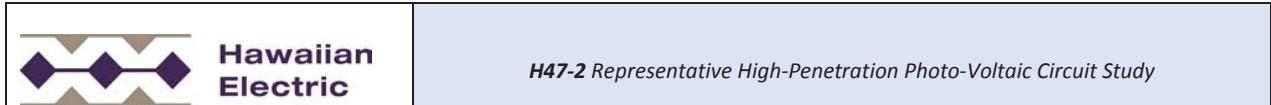

Executive Summary

The purpose of this study was to identify the risks and/or limitations of accepting more PV generation interconnections onto the H47-2 11.5 kV distribution circuit. The types of connections considered were large scale (>100 kW) three phase units, known as Feed in Tariff (FITs) installations as well as small scale (<100 kW) Net Energy Metered (NEM) installations which can be single phase or three phase.

Limitations of adding additional PV installations were identified and where possible, solutions presented which will allow additional generation of this type. In addition, this study reviewed limitations and solutions that can be applied to similar feeders throughout the Hawaiian Electric Company system.

The study plan included:

- Analyze the H47-2 feeder “as is” with the existing FITs and NEMs.
- Add the planned FITs
- Determine if there are any limitations for the existing circuit with the planned FIT PV systems.
- Determine solutions to eliminate or raise these limitations.
- Ramp up the PV penetration (NEMs only and NEMs in the presence of the existing FITs) until limits are met.
- Identify the highest penetration that can be achieved along with system modifications required to do so.

Figure 1 shows a one line diagram of the study area and includes the H47-2 feeder along with the 46-11.5kV TSF-H47 substation that supplies it. The circuit primarily being studied is the H47-2 circuit but in order to effectively analyze its performance, the other feeder supplied by TSF-H47, also known as the H47-1 feeder, was included in the study model due to the interaction from being tied to a common bus and LTC transformer.

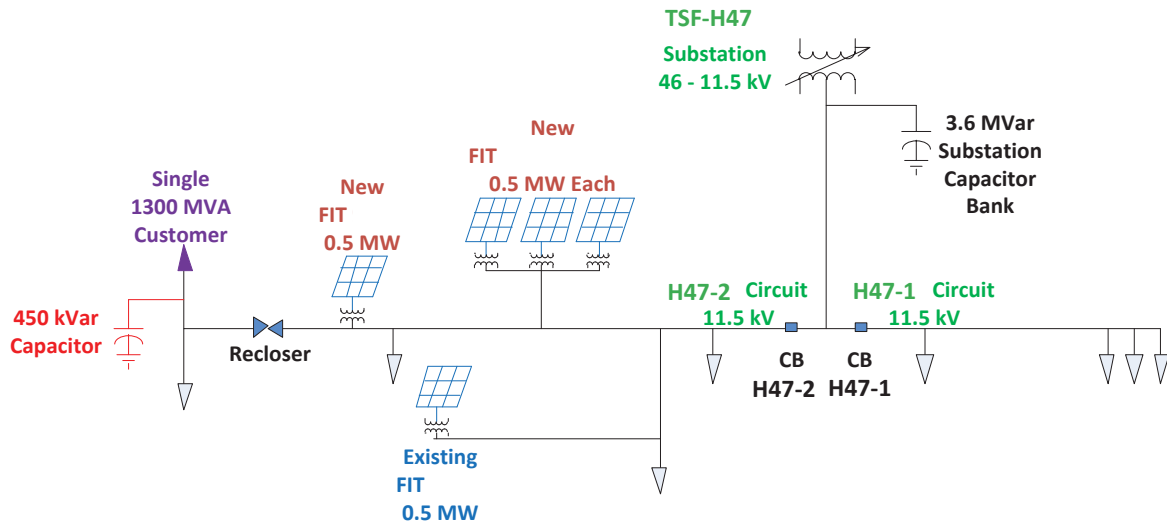
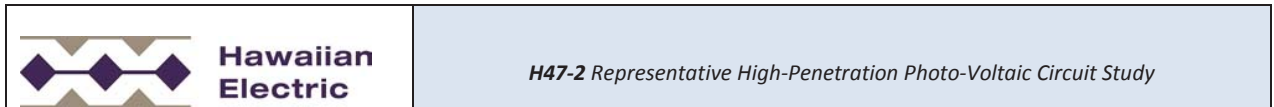

Figure 1 TSF-H47 Substation One-line Schematic

The following issues are standard considerations in accordance with IEEE 1547 for PV integration and were analyzed for this study:

1. Steady State impacts to voltage (including regulation) and equipment loading
2. Voltage Flicker – short duration voltage fluctuations that are noticeable to customers
3. Protection – relay, recloser and fuse coordination
4. Temporary overvoltage (TOV) – a short duration high voltage condition resulting from phase to ground faults or from the feeder breaker opening for other, non-fault related reasons.
5. Unintended Island – a condition where the inverters remain in service when the supply feeder trips
6. Harmonics – these are a product of generation with electronic power conversion equipment. Excessively high levels can be detrimental to equipment overheating and other operational issues.

A load flow model was used as the basis for analysis. Assumptions were made to represent typical levels of load imbalance, PV distribution and power factor of the added generation. Each topic is related to H47-2 in terms of limits on penetration and the critical issues that need to be addressed to allow higher penetration. In addition, the impact of adding PV to other similar feeders on the Hawaiian Electric Company system is quantified.

Overall Levels of Concern for HPPV on Distribution Feeders

The following table shows the likelihood of occurrence along with the criticality of each item that may be of concern for HPPV. Red cells are of very high concern, orange cells are of high concern, yellow cells are of intermediate concern, and green cells are of little or no concern.

Levels of Overall Concern		Likelihood of Occurrence or Problems Related To		
		<i>Highly Likely</i>	<i>Intermediate Likelihood</i>	<i>Unlikely</i>
Criticality	<i>Very High Priority</i>		Unintended Islands	
	<i>High Priority</i>	Voltage Problems		TOV Protection
	<i>Intermediate Priority</i>		Overload Problems	Harmonics
	<i>Moderate Priority</i>			Flicker

Table 1 Overall Levels of Concern

There are no issues that are highly likely and also of very high priority. Unintentional islanding is the only issue that cannot be totally avoided or mitigated, once 100% penetration is achieved. Even so, it does not present a safety concern to the customers. Safe work practices must be used to ensure utility workers are aware the feeder could remain energized under certain conditions even after the feeder breaker is open. Harmonic issues are unlikely since the inverter manufacturers are required to meet industry standards for harmonic output. Voltage problems and TOV are issues that can also be mitigated so they don't result in PV penetration limitations. Overloading, specifically the reverse power overload condition, cannot be remedied without significant investment in additional feeders, substations, etc.

Results

Based on this study and assuming the feeder load is at the maximum 7 MVA planning limit, a penetration level of 290% is achievable on the H47-2 feeder without system modifications. This limit is due to the reverse power overload condition and that cannot be mitigated. The 290% at full load (7 MVA) equates to about 8 MVA of PV generation. For feeders that are loaded below this level, 8 MVA of generation can still be installed. This assumes the possibility of TOV during sudden interruption of

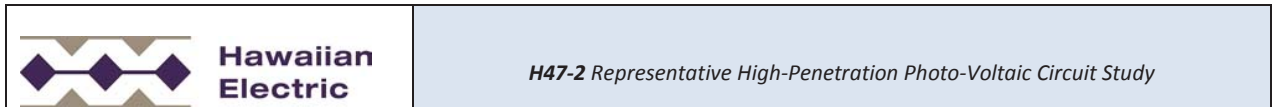

exporting power has been mitigated as recommended in the section on TOV, via transfer trip schemes with the FITs or with rapid sensing/disconnect devices on the inverter controls. It also assumes a protection review is conducted and device settings and sizes are revised as necessary to accommodate the FITs. The other areas studies require no further action to accommodate higher penetration levels.

Similar penetration levels can be achieved on other 12 kV distribution feeders assuming they have the same general topology, loading, minimum load to peak load ratio, load distribution and phase balance. Assuming the feeder planning capacity is 7MVA then 8 MVA of PV generation can be installed before reaching the reverse power flow limitation. This amount of generation can also be installed at all feeder loading levels below 7 MVA while maintaining full contingency load switching capability.

In addition to the penetration limits on individual distribution feeders there are limits on how much PV or other renewable and distributed generation can be connected to the Hawaiian Electric Company sub-transmission and transmission grid. Further study is required to determine these limits and should include impacts to normal and emergency loading, system voltages (steady state and transient) and switching and operating actions. Also, a review of Hawaiian Electric transmission planning standards and operating practices is recommended. This would be done in comparison to NERC standards. Although Hawaiian Electric is not bound by these standards, they provide established guidelines for comparison. This can be used to demonstrate why certain interconnections cannot be accepted without the requisite capital infrastructure investment to maintain reliability margins and operating performance.

It is believed, while not yet entirely verified, that additional factors may have influence on the ultimate limits and should be studied further which include:

- Circuit load phase balance
 - The amount of load on the highest loaded phase vs the average phase loading
- Circuit PV phase balance
 - The amount of PV on the highest PV penetration phase vs the average
- Circuit lateral PV penetration balance
 - The penetration of PV on one lateral vs that of another on the same circuit
- Circuit PV penetration balance
 - The penetration of PV on one circuit vs that of another fed from the same LTC/Transformer
- Transformer PV penetration
 - The PV penetration limit of the substation transformer and LTC
- Sub-transmission PV penetration
 - The PV penetration limit of the sub-transmission system

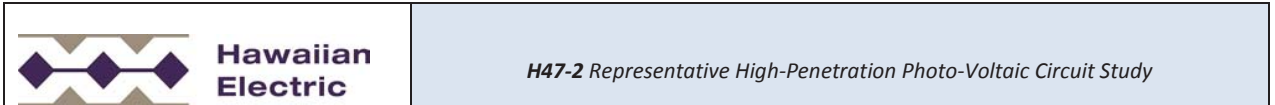

Introduction

The goal of this study was to identify the risks and/or limitations of accepting more PV generation interconnections onto the H47-2 circuit. This includes:

- Large scale (>100 kW) three phase units, known as Feed in Tariff (FITs) installations
- Small scale (<100 kW) Net Energy Metered (NEM) installations
 - single phase residential
 - single phase small commercial
 - three phase small commercial

Limitations of adding additional NEM solar installations are identified and where possible, solutions are presented which will further allow additional NEMs. Further, this study reviews limitations and solutions that can be applied to similar feeders throughout the Hawaiian Electric Company system.

The study was performed on the 11.5 kV H47-2 circuit which sits alongside of the 11.5 kV H47-1 circuit. Both of these circuits are fed from the 46-11.5 kV TSF-H47 substation. H47-2 and H47-1 are fed from a common 10 MVA transformer and Load Tap Changer (LTC). The circuit primarily being studied is the H47-2 circuit but in order to effectively analyze its performance, the H47-1 feeder was included in the study model due to the interaction from being tied to a common bus and LTC transformer.

The study plan includes:

- Analyze the H47-2 feeder “as is” with the existing FITs and NEMs.
- Add the planned FITs
- Determine if there are any limitations for the existing circuit with the planned FIT PV systems.
- Determine solutions to eliminate or raise these limitations.
- Ramp up the PV penetration (NEMs only and NEMs in the presence of the existing FITs) until limits are met.
- Identify the highest penetration that can be achieved along with system modifications required to do so.

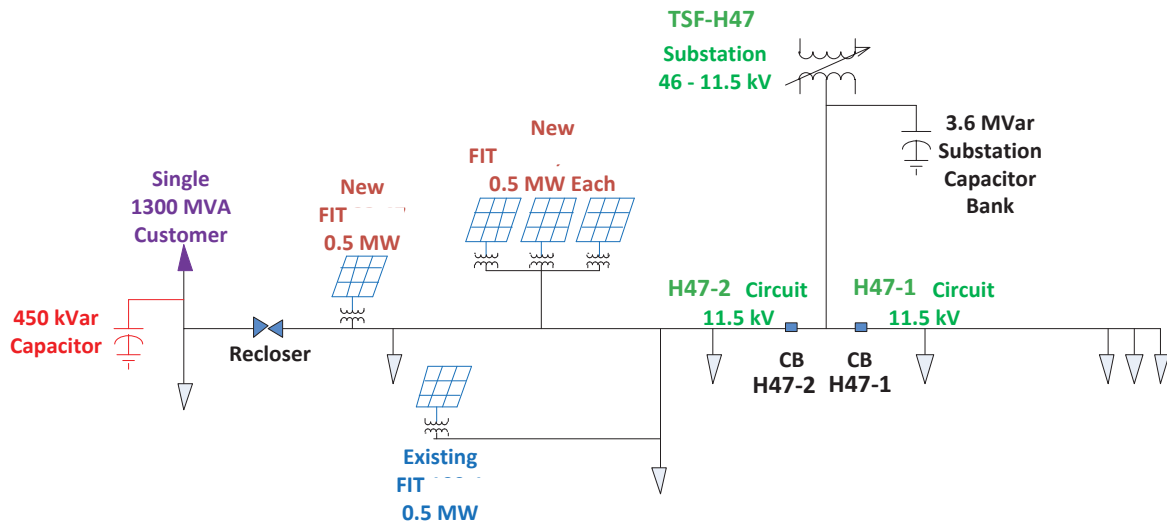
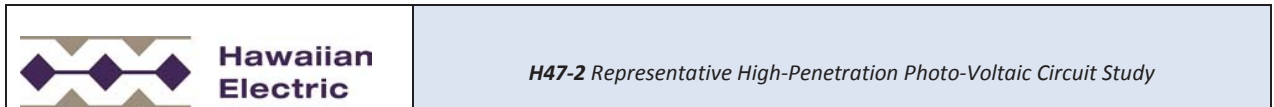

Figure 2 TSF-H47 Substation One-line Schematic

In addition to establishing the penetration limits for H47-2 the data was to be used to determine approximate limits for penetration on other feeders within the Hawaiian Electric Company distribution system.

The following issues are standard considerations in accordance with IEEE 1547 for PV integration and were analyzed for this study:

1. Steady State impacts to voltage (including regulation) and equipment loading
2. Voltage Flicker – short duration voltage fluctuations that are noticeable to customers
3. Protection – relay, recloser and fuse coordination
4. Temporary overvoltage (TOV) – a short duration high voltage condition
5. Unintended Island – a condition where the inverters remain in service when the supply feeder trips
6. Harmonics – these are a product of generation with electronic power conversion equipment. Excessively high levels can be detrimental to equipment overheating and other operational issues.

The following assumptions were made for the analysis [1]:

- Existing and proposed FIT locations were used.
- An even distribution was assumed when adding PV generation
- Existing loads are balanced within 10% among the phases.

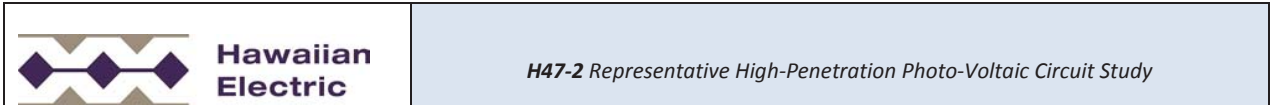

- FITs can operate between delivering 0.95 power factor vars and 0.99 power factor absorbing vars.
- The loads operate at 0.90 power factor absorbing.

Each item is addressed separately in the sections to follow. A load-flow software model was provided to UCS and used as the basis for much of the analysis. Numerous references were used that include IEEE guidelines, industry papers, books and articles are referenced in each section. Each topic is related to H47-2 in terms of:

- The critical issues are identified and the impact to the system is quantified by penetration level.
- Recommendations are made for corrective actions that allow higher penetration levels.
- The data and analysis are used to determine the impact to other similar feeders on the Hawaiian Electric Company system.

Definitions

- **Temporary overvoltage (TOV):** is something that can occur with any power delivery system. It is a situation where the voltage rises above the normal operating voltage for a very brief time.
- **Flicker:** Flicker is a rapid change in voltage level that is most noticeable with incandescent lighting
- **Unintended Island:** A condition where the inverters remain in service when the supply feeder trips.
- **Harmonics:** These are a product of generation with electronic power conversion equipment. Excessively high levels can be detrimental to equipment overheating and other operational issues.
- **Daytime Minimum Load (DML):** The minimum load on a circuit during the daytime hours (9am-5pm) over a calendar year.
- **Peak Load (Pk):** The maximum load on a circuit over a calendar year
- **Daytime Load Ratio (DLR):** The ratio of Daytime Minimum Load to Peak Load (DML/Pk)
- **Peak PV:** The maximum solar generation for a circuit over a calendar year.
- **% Penetration:** the PV generation divided by the load, expressed as a percent. It is a representation of the generation to load at a given time. This is an “instantaneous” value using hourly, 15 minute or minute data.
- **Solar Penetration:** the PV generation divided by the load, expressed as a percent. It is a representation of the generation to load at a given time. This is an “instantaneous” value using hourly, 15 minute or minute data.

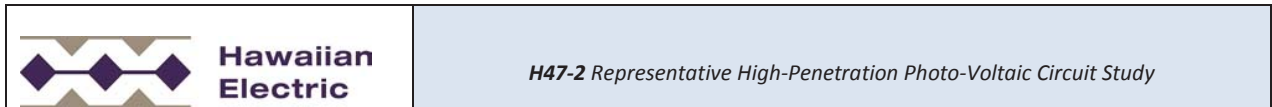

- **PV Penetration:** the PV generation divided by the load, expressed as a percent. It is a representation of the generation to load at a given time. This is an “instantaneous” value using hourly, 15 minute or minute data.
- **Minimum Load to Generation Ratio (MLGR):** the Peak PV divided by the DML, expressed as a percent. This is the “worst case” scenario of the most PV generation at any time of the year over the minimum circuit load at any time of the year. These values do not necessarily coincide in time.
- **NEM-Penetration:** % Penetration of all NEM’s (Net energy metered) connections on the circuit (this excludes the FIT’s, SIA’s etc.)
- **NEM-MLGR:** MLGR of all NEM’s (Net energy metered) connections on the circuit (this excludes the FIT’s, SIA’s etc.)
- **High Penetration Photo-Voltaic (HPPV):** High levels of distributed NEM type of PV on a circuit typically above 50% penetration
- **Minimum Load to Generation Ratio (MLGR):** the Peak PV divided by the DML, expressed as a percent. This is the “worst case” scenario of the most PV generation at any time of the year over the minimum circuit load at any time of the year. These values do not necessarily coincide in time.
- **NEM-Penetration:** % Penetration of all NEM’s (Net energy metered) connections on the circuit (this excludes the FIT’s, SIA’s etc.)
- **NEM-MLGR:** MLGR of all NEM’s (Net energy metered) connections on the circuit (this excludes the FIT’s, SIA’s etc.)
- **High Penetration Photo-Voltaic (HPPV):** High levels of distributed NEM type of PV on a circuit typically above 50% penetration
- **Extremely High Penetration Photo-Voltaic (EHPPV):** High levels of distributed NEM type of PV on a circuit typically above 100% penetration
- **Stiffness Factor:** The available short circuit current at the point of interconnection divided by the DG rated output current.
- **Load Curve:** A load curve is a plot of the feeder load over a 24 hour period.
- **Solar Curve:** The solar generation profile follows the intensity of the sun.
- **Net Energy Metering (NEM):** Solar installations typically less than 100 kW smaller single-phase or three-phase rooftop installations
- **Feed-In Tariff (FIT):** Solar installations typically larger than 100 kW typically larger three-phase commercial installations
- **Real Power (P):** Active electrical power that produces work as can be seen in the illumination of an incandescent lamp. The units for Real Power are Watts (W).
- **Reactive Power (Q):** This is the power that is produced and/or consumed by devices which use or involve magnetic circuits such as motors. Transformers, wires, motors, inductors, and

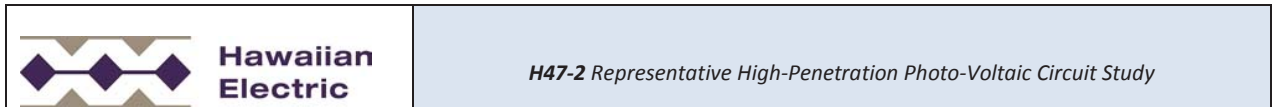

- capacitors are all involved in the production and/or consumption of reactive power. The Units for Reactive power are Volt-Amps Reactive (var).
- **Apparent Power or Complex Power (S):** The total power produced and/or consumed. This is a combination of the Real Power and the Reactive Power. The Real and Reactive powers are mathematically orthogonal to each other. Therefore, to find the Apparent power from Real and Reactive power one must use the Pythagorean Theorem ($S^2 = P^2 + Q^2$). The units for Apparent Power are Volt-Amps (VA).
 - **Power Factor (pf):** The ratio of real power flowing to the load, to the apparent power in the circuit. This is a unit-less value.
 - **Circuit Penetration Imbalance:** The unevenness of PV penetration between different circuits fed from the same substation transformer
 - **Lateral Penetration Imbalance:** The unevenness of PV penetration between different laterals of the same circuit
 - **Phase Penetration Imbalance:** The unevenness of PV penetration between phases of the same circuit or same substation transformer
 - **Reverse Flow:** Power on a utility circuit typically flows from the substation down to the customer. In the presence of distributed PV, as what Hawaiian Electric Company is seeing, it is possible for there to be enough distributed generation so as to cause power to flow in the reverse direction on the feeder to what has historically been typical. Reverse flow in itself is not a problem so long as equipment controls and equipment ratings are sized appropriately for the amount of reverse flow.
 - **Reverse Overload:** When there is sufficient reverse flow to exceed the equipment thermal ratings due to the magnitude of current flow
 - **Load Rejection:** A condition in which there is a sudden trip of the load. In the context of HPPV it is when the substation circuit breaker opens for a line. This is particularly relevant when there is more solar generation on the line than load on the line and there is a reverse flow of power through the circuit breaker.
 - **Load Tap Changer (LTC):** A device adjacent to the substation transformer that has several smaller windings in series. Each winding has a “tap” that can be selected in discrete steps. The result is a transformer with a Variable number of turns that allows for the regulation of voltage. In the case of a TCUL or an LTC the taps can be changed while the transformer is energized and serving load. This is the device that regulates the voltage at the substation.

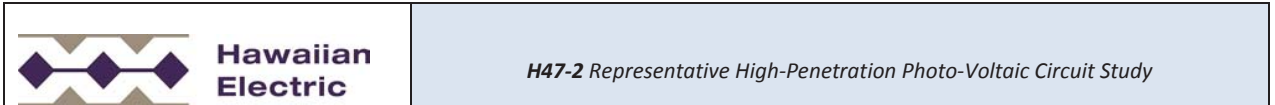

Categories and Priority of Issues/Concerns with HPPV

There are four primary categories of issues and/or concerns when evaluating different impacts of HPPV on the distribution system. In order of highest priority/criticality to least the categories for problems include:

1. **Safety:**

- **Criticality:** (**Very High Priority**) Safety is by far the highest priority when it comes to evaluating issues and concerns on the power system. Safety problems can lead to injury and/or death.
- Safety can be broken into two sub-categories:
 - **Public Safety:** Concerns around public safety may relate to danger to the general public who may not be educated in electricity. This is the basis for much of the National Electric Safety Code and the National Electric Code and covers topics such as approach distances and clearances etc.
 - **Workman Safety:** Concerns around workman safety relate more to injury to employees. These conditions may arise in situations where the workman may be trained and perform work on electric systems where the public may have no or limited access. An example of this may be working from a bucket truck to repair a damaged line, etc.

2. **Equipment Damage:** Equipment damage is typically a result of abnormal conditions on the power system. Equipment is designed under specified operating parameters, but when subjected to abnormal operating conditions minor damage to catastrophic equipment failure can ensue.

- **Criticality:** (**High Priority**) Equipment damage is a high priority as it may not just be the cost, time and manpower related to the equipment damage itself, but it may contribute to conditions that could damage other equipment, become a safety concern or cause a service interruption.
- Equipment damage discussed in this document is broken into two sub-categories:
 - **Voltage Damage:** Over or under voltage conditions can damage equipment. Over voltage conditions typically lead to insulation failure and burning up of more sensitive components such as electronics. Often these conditions are temporary in nature and thus are referred to as Temporary Over-Voltage (TOV) which will be addressed in greater detail in this document.
 - **Thermal Overload:** Thermal overload can occur when equipment is subjected to more current than what it is designed for. The typical result from thermal overloading is for the component to melt. An example of this is for a line section to be subjected to excessive current and for it to melt.

 Hawaiian Electric	<i>H47-2 Representative High-Penetration Photo-Voltaic Circuit Study</i>
--	--

3. **Equipment Operation:** Equipment can be subjected to conditions which it was not originally designed. Equipment operation problems may not necessarily cause the equipment to fail, but rather miss-operate.
 - **Criticality: (Intermediate Priority)** Equipment operation problems are of an intermediate priority as the miss-operation may not be of tremendous concern and the miss-operating device may not be damaged, but it may lead or contribute to conditions that could damage equipment, become a safety concern or cause a service interruption.
 - An example of this is to subject a voltage regulator to reverse power flow without changing its control settings to a mode designed for reverse power flows. In this case the regulator will still try to do its job but will end up regulating in such a way as to raise the voltage when in fact the voltage needs to be reduced and vice versa.
4. **Customer Perception:** Customer perception is the least critical of the issues/concerns.
 - **Criticality: (Moderate Priority)** While these situations may occasionally lead to annoyances to customers no people or equipment damage will result nor is a service interruption likely.
 - An example of customer perception issue is Flicker. No equipment is damaged as a result of flicker nor do any safety issues arise.

To what extent possible/practical this report will attempt to specify which category each studied condition applies to help clarify the relative level of criticality of each condition that can arise as a result of HPPV on the distribution system.

Steady State Study

The steady state study uses Load-Flow software to simulate how the power system responds to different conditions on the power system and is used to evaluate voltage regulation, voltage violations, and thermal ratings. A load-flow analysis is based on system components, system configuration and load and/or generation data of a specific snapshot in time. System components do not change with much frequency, on the order of months or years. System configuration changes, switches opening and closing, with greater frequency, on the order of days to months. Load and/or generation levels change with much higher frequency, on the order of seconds to hours. Load-flow primarily evaluates the response of System components and System configuration to a set of load and/or generation data. Given that the load and generation data change with such frequency it is common practice to model the minimum load and peak load as two separate load cases for study in Load-flow software. This approach was appropriate to catch the most extreme conditions likely to appear when the utility served the entire load from the substation down the feeder. However, this approach may not hold entirely for the case of distributed generation particularly when the distributed generation is in the form of PV. In this research

 UC SYNERGETIC <i>Innovative Thinking. Engineered Solutions.</i>	Filename: H47-2_Final.Docx Modified: 2/25/14 Page: 18 of 113
---	--

 Hawaiian Electric	<i>H47-2 Representative High-Penetration Photo-Voltaic Circuit Study</i>
--	--

multiple load and PV cases are analyzed in order to better compensate for the wider Variation of possible scenarios that may arise in the case of HPPV.

At some point it may be valuable to perform an hourly load flow of a feeder for an entire year (8760 hours) to gain a clearer understanding of the behavior of HPPV on the Hawaiian Electric Company system.

Criticality

Voltage regulation, voltage violations, and thermal ratings which are reviewed as part of the steady state studies all fall within the Equipment Damage and Equipment Operation categories of Priority of Issues/Concerns. These topics carry **High and Intermediate Priorities** with respect to criticality.

Likelihood of Occurrence or Problems Related To:

Voltage and thermal overload conditions are unlikely up to 290%, assuming the feeder is loaded to the planning limit of 7MVA. Beyond that, reverse power overload becomes a possibility. For feeders loaded below 7MVA the percent penetration can increase without incurring overload or voltage issues.

H47-2 Original Load-Flow Model

The existing model includes:

- 138 kV Substation (Transmission Substation)
- 138 kV Transmission Line
- 46 kV sub-transmission circuit
- 46 kV substation (TSF-H47 Substation)
- 10 MVA 46-12 kV transformer
- Two 12 kV circuits
 - H47-1
 - H47-2
 - 5 FIT projects with +.95 pf (producing vars)
 - 1 Existing
 - 4 New

H47-2 Study Load-Flow Model

Model additions include:

- Added source impedance provided by Hawaiian Electric Company protection group for short circuit calculations

 UC SYNERGETIC <i>Innovative Thinking. Engineered Solutions.</i>	Filename: H47-2_Final.Docx Modified: 2/25/14 Page: 19 of 113
---	--

 Hawaiian Electric	<i>H47-2 Representative High-Penetration Photo-Voltaic Circuit Study</i>
--	--

- TSF-H47 46kV Substation
 - POS SEQ: 14.9713+j28.0589 Ω
 - NEG SEQ: 14.9713+j28.0596 Ω
 - ZERO SEQ: 24.1903+j102.581 Ω
- Transmission Source 138kV
 - POS SEQ: 0.7186+j6.60025 Ω
 - NEG SEQ: 0.71851+j6.60661 Ω
 - ZERO SEQ: 3.56697+j17.4147 Ω
- 60 solar generation installations modeled on H47-2 (one per model feeder section)
 - Each .99 pf (consuming vars)
 - Inverter based PV model
 - 3 phase
 - Each 100 kW or 200 kW depending on the needs for the particular study
- In the case of H47-2, the large var demand of the large commercial load at the very end of the feeder will tend to limit the ultimate circuit loading and the ultimate solar penetration on the H47-2 circuit. It will also lead to more circuit I²R losses and more voltage problems as the load on the circuit increases. Therefore, the H47-2 circuit was var corrected by adding two 450 kvar capacitor banks adjacent to large load at the end of H47-2. One capacitor bank was turned off for the lower load case.¹

Things to Note about the Model

- H47-2 has two main branches
 - One main branch goes to a 1 MVA load on the very last section of the main branch
 - Another main branch which has no particularly distinguishing characteristics
- The H47-1 circuit is served from the same transformer as H47-2
 - No solar specially modeled on this circuit for this study initially
- Due to the format of the H47-2 model provided by Hawaiian Electric Company, SynerGEE Electric Load-Flow software was used for all the Steady State Load-Flow and Harmonic studies.

¹ It is good practice to var correct feeders in order to minimize losses, minimize voltage drop, and to maximize ultimate feeder loading potential. Var corrected feeders save the utility in operations costs by reducing the losses, and save the utility in capital costs by getting maximum capacity out of existing assets.

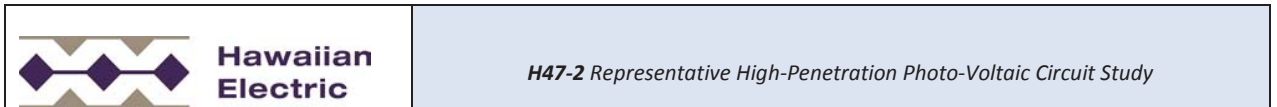

Study Methodology

This part of the study is primarily focused on voltage regulation, voltage deviations, and thermal overloads at various loading and penetration levels. In order to get a broad picture of what happens with high penetrations of NEMs a bracketed approach was taken to the study. Solar penetration is based on the modeled feeder load. Approximately 90% of Hawaiian Electric Company circuits that have solar only have NEMs or FITs less than 100 kW. Therefore, a key focus of the study is to evaluate circuits without large FIT installations. The distinctions between “Circuit Penetration” and “NEM Penetration” for the purposes of this study are as follows:

- Circuit Penetration: All solar kW on the circuit divided by the total circuit load² to include both NEMs and FITs
- NEM Penetration: All NEM kW on the circuit divided by the total circuit load to include only NEMs and neglecting FITs.

For each permutation of feeder load, NEM Penetration and FITs load-flow studies are run in order to get better understanding of voltages, voltage regulation and voltage performance.

² Circuit load may be the feeder peak; feeder min, day-time minimum load, or whatever load is being analyzed.

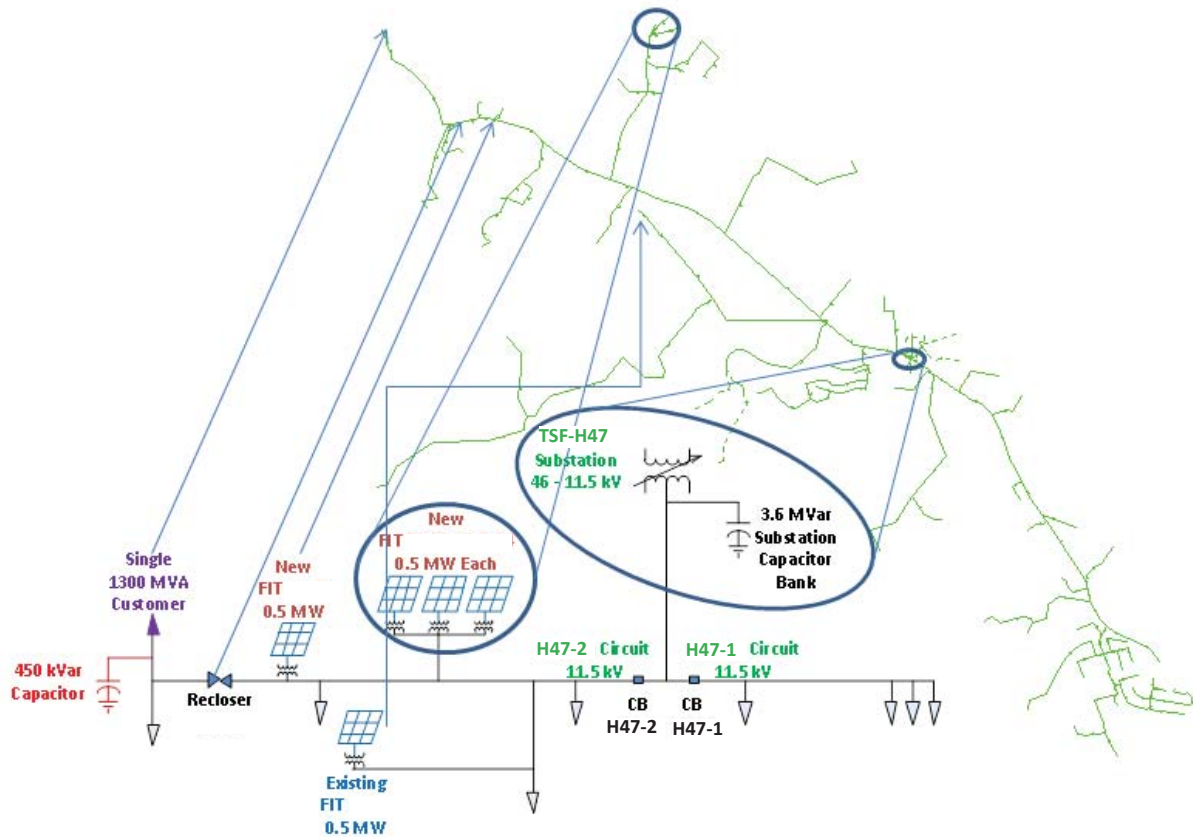

Figure 3 Image and 1-Line Schematic of TSF-H47 Substation model used for study

The Steady State Study was broken into three stages:

- Stage 1: Compare and validate the model used against the original model
- Stage 2: Study NEMs only up to 200% penetration
- Stage 3: Study NEMs and FITs up to 300% penetration

Three feeder loads were modeled for the studies which include:

- 1573 kVA – H47-2 Daytime Minimum Load (DML)
- 2869 kVA – H47-2 Peak Load (Pk)
- 4000 kVA – Higher Load Case

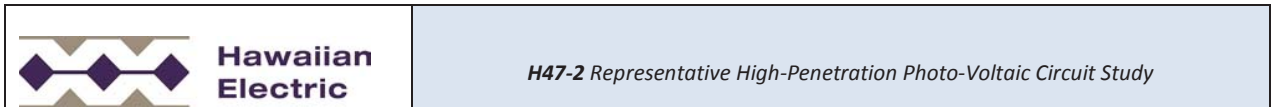

Each feeder load was modeled with several different penetrations of NEMs and FITs to include:

- 20% - 200% and 300% NEM Penetration without 5-FITs (Stage 2 of the Evaluation)
 - Steps of 20% penetration
- 160% - 300% Total Penetration with 5-FITs (Stage 3 of the Evaluation)
 - Steps of 20% penetration
 - .99 pf consuming vars
 - .95 pf producing vars

Data was recorded at three points along the backbone of both circuits to get a clear picture of circuit behavior to include:

K_TAP1-TAP2	Circuit Source - H47-2
K_TAP8	Mid-Circuit - H47-2
K_TAP12	Circuit End - H47-2
Kah_TAP1-2	Circuit Source - H47-1
Kah_TAP8-9	Mid-Circuit - H47-1
Kah_TAP12D2	Circuit End - H47-1

The data recorded for each section include:

- Real Power in kW
- Reactive Power in kvar
- Voltage in Per-Unit

The actual data captured is presented in Table 2 Base Model + FITS ON +95 (var producing).

Stage 1: Model Validation

The objective of the overall research being performed to find “generalized” solutions that can be applied to the rest of the Hawaiian Electric Company System does not necessarily depend on the accuracy of the H47-2 circuit model. However, some of the focus of this research is to evaluate the ultimate penetration limit of H47-2 in the presence of the FIT projects that exist and are proposed on that circuit. Therefore, Load Flow was run on the study model using DML. The voltage results of the study model were compared to voltages from the same line sections of the original model in order to verify that the results were comparable and that the modified study model is comparable to the original.

 Hawaiian Electric	<i>H47-2 Representative High-Penetration Photo-Voltaic Circuit Study</i>
--	--

Base Model + FITS ON +95 (Var producing)		
	Study Model	Original Model
Circuit Source - H47-2	1.022	1.024
Mid-Circuit - H47-2	1.027	1.027
Circuit End - H47-2	1.025	1.024
Circuit Source - H47-1	1.022	1.023
Mid-Circuit - H47-1	1.014	1.017
Circuit End - H47-1	1.011	1.012

Table 2 Base Model + FITS ON +95 (var producing)

As shown in Table 2 Base Model + FITS ON +95 (var producing) the voltages are comparable. While the initial tap setting, voltage at the circuit source, is slightly different from one model to the other the overall voltage drop along the line is very similar. The starting point for the study is to assume the load on HPPV circuits has been var corrected.

Base Model + FITS ON -99 (Var consuming)	
	Study Model
Circuit Source - H47-2	1.008
Mid-Circuit - H47-2	1.007
Circuit End - H47-2	1.005
Circuit Source - H47-1	1.008
Mid-Circuit - H47-1	1.000
Circuit End - H47-1	0.997

Table 3 Base Model + FITS ON -99 (var consuming)

The next step is to compare the five FITs operating at .95 power factor (producing vars) to the five FITs operating at a -.99 power factor (consuming vars). In the study model the NEMs are modeled with a -.99 power factor. The commercial solar installations, the FITs, tend to primarily be profit motivated. Operating inverters in a mode to which they are providing vars back to the distribution system by having the pf set to .95 actually reduces the inverters output capability. Therefore, it is not in the financial interest of the FIT operators to operate at .95. With this in mind, it was considered to be worthwhile to verify that if the large Fit Installations operate at -.99 pf rather than the recommended .95 pf that no voltage problems arise. As seen in Table 3 Base Model + FITS ON -99 (var consuming) there are no voltage issues of concern even near the mid circuit of H47-2 where the highest concentration of FITs are located.

 UC SYNERGETIC <i>Innovative Thinking. Engineered Solutions.</i>	Filename: H47-2_Final.Docx Modified: 2/25/14 Page: 24 of 113
---	--

 Hawaiian Electric	<i>H47-2 Representative High-Penetration Photo-Voltaic Circuit Study</i>
--	--

Inverters with power factor correction regulate the pf to near unity, enough so to be marketed as operating at unity. Without power factor correction the pf is a function of inverter output. With power factor correction, while pf is still a function of inverter power output it is far less so. IEC EN 61000-3-2 [2] is the only standard found as part of this research which addresses pf in relation to inverter power output. The IEC standard allows for a 1% Variance in the pf. While 1% is quite close to unity and is negligible in small-single PV installations. The aggregate of hundreds of small PV installations and/or a large installations operating at 1% off of unity can have a measurable impact on the var consumption on the feeder. The additional var consumption can contribute to voltage drop and voltage performance. In this research the NEMs were modeled at -.99 pf to capture the potential for the solar inverters installed feeding back on to the Hawaiian Electric Company to be operating slightly off unity. In order to ensure that the results in this project can be compared to results in other research a load-flow was run at unity and another at -.99 pf. These findings are presented in Table 4 Inverter @ Unity vs. .99 pf Comparison.

Table 4 Inverter @ Unity vs. .99 pf Comparison illustrates that the -.99 pf has some impact on the voltage drop along the backbone of the feeder. The 1% potential Variation of hundreds of inverters installed on the feeder can amount to a significant increase in var demand on the feeder. This additional potential var demand needs to be investigated further using metering in the field.

RESULTS COMPARISON FOR UNITY pf Vs -99 pf for NEMs
LTC@0+ FITS OFF + PEAK LOAD+ NEM Penetration@ 100% (V, KW, KVAR measurements) Peak Load 2583 KW @ 90% PF 100% NEM Penetration Results for NEMs with -99 pf and Unity pf (Red text is for -99 pf and Blue text is for Unity pf case)

% Change in reference to Unity Power Factor												
	Voltage	Voltage	% Change	KW	KW	% Change	KVAR	KVAR	% Change	KVA	KVA	% Change
Circuit Source - H47-2	119.36	120.27	0.756631	254	276	7.971014	724	355	-103.944	767.2627	449.6677	-70.6288
Mid-Circuit - H47-2	118.92	120.05	0.941274	580	596	2.684564	85	-96	188.5417	586.1954	603.682	2.89667
Circuit End - H47-2	118.75	119.91	0.967392	1104	1118	1.252236	-204	-258	20.93023	1122.69	1147.383	2.152157
Circuit Source - H47-1	119.3	120.21	0.757009	2606	2629	0.874857	1208	1212	0.330033	2872.368	2894.924	0.779145
Mid-Circuit - H47-1	117.39	118.39	0.844666	1941	1954	0.665302	892	898	0.668151	2136.152	2150.47	0.665799
Circuit End - H47-1	116.81	117.71	0.764591	1161	1169	0.684346	529	533	0.750469	1275.838	1284.776	0.695723

Table 4 Inverter @ Unity vs. .99 pf Comparison

Stage 1 Summary

Stage 1 of the study verifies that the model is comparable to the original model and is appropriate for use in the HPPV study. Stage 1 also shows how using .99 pf for the inverters has very little impact on the voltage but has a measurable impact on var flow in the case of HPPV.

	Filename: H47-2_Final.Docx Modified: 2/25/14 Page: 25 of 113
---	--

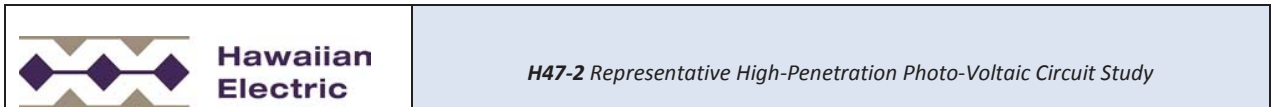

Stage 2: NEMs Evaluation

In this stage of the load flow evaluation the FITs were turned off and the NEMs were turned on. This evaluation breaks away from specifically studying H47-2 as it was at the time of the study and extends the evaluation to NEM Penetration on an arbitrary 11.5 kV circuit. This stage of the study is specifically focused on what might be expected on “similar” circuits in the Hawaiian Electric Company system in the presence of small rooftop HPPV. While the study model does closely represent the H47-2 circuit, close representation of H47-2 is not the focus nor is it necessary for this stage of the load-flow study.

The study model includes sixty 100 kW PV installations, one for each line section of the H47-2 circuit. By having a PV installation on each modeled line section the result is a generally even distribution of PV across the H47-2 circuit. Each of the 100 kW PV installations is a 3 phase installation, which makes the PV evenly distributed across phases. Neither of these conditions is necessarily reality in the field. The more or less even distribution of solar is believed to be sufficient for the initial research into rooftop HPPV. It is advised that further research should extend this work to review:

- Circuit Penetration Imbalance
- Lateral Penetration Imbalance
- Phase Penetration Imbalance

With aforementioned caveats in mind the NEM installations were scaled from 20% to 200% in increments of 20% based on the circuit kW load. An additional penetration of 300% was run to compare with the LPV findings of 300% penetration limit due to reverse flow thermal limitations.

Generally speaking beyond and including this evaluation voltage problems are more prevalent on heavily loaded circuits. Lightly loaded circuits require very little use of the Load-Tap Changer (LTC) and have lower requirements for capacitor support or Var correction. For all the penetration three different load levels were modeled which include:

- 1573 kVA – this is the annual minimum daytime load for the H47-2 circuit
- 2869 kVA – this is the annual maximum load for the H47-2 circuit
- 4000 kVA – this is an alternative high load case to help evaluate higher loading conditions

Stage 2 Summary

While in many cases the LTC would have to operate in order to regulate the substation voltage within the desired range, in all cases up to 300% penetration no voltage violations were found on the feeder backbone or any of the feeder laterals (what was modeled in the study model).

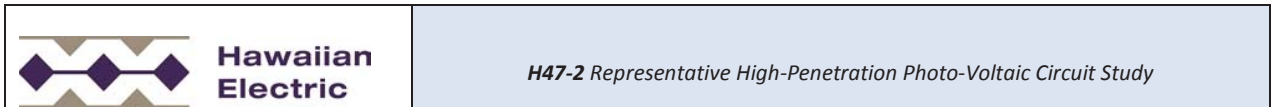

Stage 3: NEMs with FITs Evaluation

In this stage of the load flow evaluation the FITs and the NEMs were turned on. This stage of the evaluation more closely simulates H47-2 as it was at the time of the study and extends the NEM penetration beyond what H47-2 had the time of the study. This stage of the study is specifically focused on what might be expected on “similar” circuits in the Hawaiian Electric Company system in the presence of small rooftop HPPV when combined with larger FITs on the same circuit.

The study model includes sixty 100 kW PV installations, one for each line section of the H47-2 circuit. By having a PV installation on each modeled line section the result is a generally even distribution of PV across the H47-2 circuit. Each of the 100 kW PV installations is a 3 phase installation, which makes the PV evenly distributed across phases. Neither of these conditions is necessarily reality in the field. The more or less even distribution of solar is believed to be sufficient for the initial research into rooftop HPPV. It is advised that further research should extend this work to review:

- Circuit Penetration Imbalance
- Lateral Penetration Imbalance
- Phase Penetration Imbalance

With aforementioned caveats in mind the NEM installations were scaled from 160% to 300% in increments of 20% based on the circuit kW load. For all the penetration levels the same three load levels that were used in Stage 2 were used in Stage 3.

Stage 3 Summary

While in many cases the LTC would have to operate in order to regulate the substation voltage within the desired range, in all cases up to 300% penetration no voltage violations were found on the feeder backbone or any of the feeder laterals (what was modeled in the study model).

No voltage violations are indicated for NEMs to 200% or for NEMs with FIT’s to 300%. No thermal overload conditions are indicated from the steady state study.

Implications to H47-2

No voltage or thermal over load conditions are indicated to 300% penetration.

 Hawaiian Electric	<i>H47-2 Representative High-Penetration Photo-Voltaic Circuit Study</i>
--	--

Application to other feeders

No voltage or thermal over load conditions are expected up to 290% penetration and with as much as the planning limit of 7MVA load. Longer feeders should be specifically studied to verify HPPV does not lead to voltage violations on very long feeders.

Protection

Criticality

Protection falls within the Equipment Damage and Equipment Operation categories of Priority of Issues/Concerns. These topics carry **High and Intermediate Priorities** with respect to criticality.

Likelihood of Occurrence or Problems Related To:

In general protection problems are unlikely. The fault contribution due to inverter-based generation is generally not sufficient, even at high penetration levels, to significantly impact the protection scheme. Periodic review of device interrupting ratings, loading, reach, and coordination is generally accepted engineering practice in any distribution system.

Protection Review

For any Distributed Resource, the contribution to system available fault current must be considered. For rotating machines such as induction or synchronous generators this could be significant, possibly 4 – 10 times the rated steady state current of the generator. Fortunately, for inverter based DG such as solar PV, fault contribution is significantly less. The fault contribution from an inverter is specified by the manufacturer, but typically falls in the range of 1 – 1.25 times the output of the inverter. For the purposes of this study, we assumed fault contribution of 1.2 times the inverter rating. This value is consistent with other studies performed on behalf of Hawaiian Electric Company and other utilities.

On a 12 kV system, this results in approximately 55 amps fault contribution per megawatt of rated solar PV output. While the effect of any individual smaller PV unit is minimal, the total contribution should be taken into account with particular consideration to the spatial distribution of solar PV. For the purpose of this representative study, only FIT locations were considered -- precise locations of smaller PV units, or NEMS, were not known. The effect of fault contribution will be more noticeable on portions of the feeder where large PV (> 1 MVA) is concentrated. There is a remote possibility for these large FITs to exceed the ratings of protective devices out on the feeder, such as fuses and reclosers and therefore

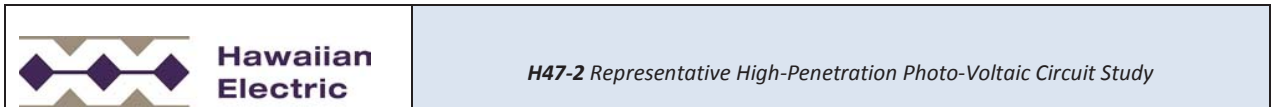

should be investigated individually. In addition, the coordination of protective devices should be reviewed when connecting large FIT installations.

There is a remote possibility for the additional fault current from large FIT installations to adversely impact fuse saving schemes or protective device coordination. It should be noted, that the fault contribution from solar PV at the substation bus will be minimal. Faults on the feeder beyond the substation will experience the additional fault contribution, but not the feeder breaker. With that understanding, the presence of solar PV on the feeder will not require a review of the interrupting rating of the feeder breaker.

Other considerations

The available fault current on a system is an indicator of the type of steady state and temporary issues that might be expected from any type of operation that could involve a change in voltage. This applies to not only distributed generation, but also motor starting and capacitor switching as well. A handy tool that can be used to evaluate the potential for adverse system affects from DG is the Short Circuit Current Ratio, or SCCR, which is the ratio of the fault contribution of the DG to the utility fault contribution, expressed in percent. SCCR is defined in the equation below:

$$\% \text{ SCCR} = (I_{SC \text{ DG}} / I_{SC \text{ utility}}) \times 100$$

Industry experience has shown that where the SCCR is 5% or greater, potential system impacts may raise a flag [3] and more detailed study is warranted.

Inversely, the ratio of utility short circuit contribution to DG short circuit contribution should be 20 or more, or

$$\text{Where } (I_{SC \text{ utility}} / I_{SC \text{ DG}}) \geq 20, \text{ no adverse impacts are expected [3].}$$

For the Hawaiian Electric Company system, available fault current at the substation bus is typically around 5000 amps. This is based on a typical substation with a 10 MVA transformer at approximately 9% nameplate impedance. Using the guideline above, 5% of 5000 A = 250 A. The maximum ampacity of the wire for Hawaiian Electric Company is approx. 400 amps. The DML can be calculated as 40% of the peak load [4], so for a circuit loaded to its maximum ampacity the DML would be about 160 amps. Considering a feeder with is 100% penetration means about 160 Amps of solar. Assuming the fault contribution of the inverter based PV is 1.2 times of the rated capacity, the total short circuit duty contribution from solar should not exceed 1.2 x 160 = 192, or roughly 200. So for 100% penetration for the faults near the substation this will give a ratio of about 200 / 5000 = 25. Therefore, no issue is expected based on the 5% guideline.

 Hawaiian Electric	<i>H47-2 Representative High-Penetration Photo-Voltaic Circuit Study</i>
--	--

Looking at it a different way, remember 1 MVA of solar results in an additional 55 amps fault contribution. This means that any location on the system where the utility fault current is less than 1100 amps the potential exists for adverse impact. This is rare on the Hawaiian Electric Company system. This is covered more under the flicker section.

For adding NEMs to circuits with up to 300% penetration, the short circuit current contribution is not expected be significant enough to require changing the protection settings on the breaker. However, for the faults far away from the station short circuit current drops significantly and the relay can have greater difficulty distinguishing between fault and load current at the end of very long lines. In these cases it is important to rely on the inverters or some local form of protection to distinguish local faults closer to the end of electrically long lines³. Interconnection standards UL 1741 and IEEE 1547 are helpful to address these protection issues.

% of Pick-Up	Time to Trip
115%	shall ultimately trip
150%	2.0 Seconds
250%	1.0 Second

Table 5 UL 1741 Table 54.1 Operating Time

In the case of end of line faults on long lines where the relay already has difficulty distinguishing between load and fault current, the solar will most likely trip faster than the circuit breaker. However, this would not address the preexisting condition of the circuit breaker tripping for distant faults.

While protection issues are not specifically expected for NEMs, there is standard calculation that ensures there will be no issues for HPPV exceeding 100% under HECO’s situation where the solar is typically small rooftop installations less than 100 kW.

Implications to H47-2

In general, for distribution feeders with fault levels and loading characteristics similar to the H47-2 study feeder, protection problems are unlikely at the substation circuit breaker, at mid-circuit reclosers, or a backbone or lateral fuses. On the H47-2 feeder, no adverse impacts to the protective coordination scheme were identified. It should be noted again that precise NEM locations were not known, so local impacts to fuse saving and, while unlikely, recloser operations may be impacted. Measurement of

³ Long line could mean significant amounts of impedance between the fault location and the station, which can be physically long lines or high impedance wire or the combination of low voltage lines with high impedance wire.

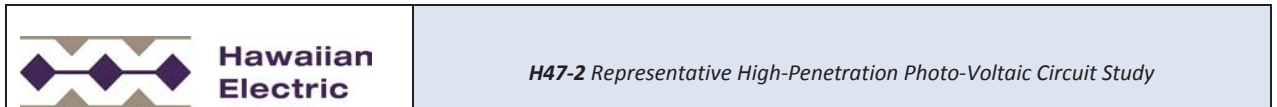

actual values, through the use of electronic reclosers and comprehensive programs to gather and analyze fault data, is strongly recommended.

Application to other feeders

In general protection problems are unlikely at the substation circuit breaker, at mid-circuit reclosers, or a backbone or lateral fuses. While unlikely, recloser operations may be impacted. Measurement of actual values, through the use of electronic reclosers and comprehensive programs to gather and analyze fault data, is strongly recommended.

Flicker

Criticality

Flicker falls within the Customer Perception category of Priority of Issues/Concerns. This topic carries a **Moderate Priority** with respect to criticality.

Likelihood of Occurrence or Problems Related To:

It is unlikely that voltage flicker due to PV penetration of any level will be perceptible to customers.

Flicker Review

IEEE 1453 [5] defines voltage flicker as:

- Impression of unsteadiness of visual sensation induced by a light stimulus whose luminance or spectral distribution fluctuates with time.
- NOTE: Flicker is the effect on the incandescent lamps while the electromagnetic phenomenon causing it is referred as voltage fluctuations.

Simply put, flicker is a rapid change in voltage level that is most noticeable with incandescent lighting. It is a customer perception issue and it generally not something that is detrimental to equipment or system operations. On the distribution system this is typically caused by things such as:

- Motor starting
- Rapid connection or disconnection of loads
- Loads that change rapidly such as arc welders
- Capacitor bank switching

Some utilities use flicker irritation curves such as the one shown in Figure 4 Flicker Curves (known as the GE flicker curve) to determine the limits of flicker.

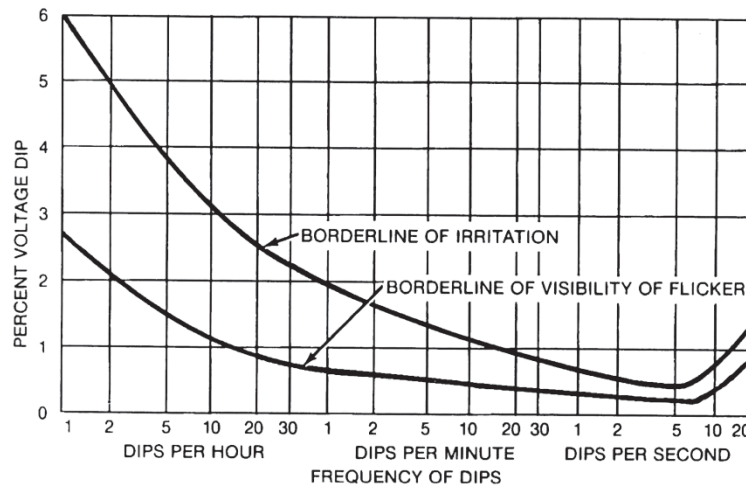

Figure 4 Flicker Curves

The curves show flicker irritation is a function of the magnitude of the fluctuation and the frequency of occurrence. For a PV system there are two cases that can result in flicker:

- Full on or full off of the PV plant.
- Clouding; this is where cloud cover reduces the PV output resulting in voltage Variations on the feeder. This also includes the voltage change when the clouds clear and the PV output increases.

Full on or full off of the PV generation should be a rare event. For the full on case, the inverters have a ramp rate that limits the visual impact of the change in PV generation. This rate is typically adjustable for larger three phase inverters and is factory set for single phase inverters. Either way the time required from turn on to full output is from one to several seconds or even minutes for larger inverters. This is not a rapid fluctuation defined as flicker and is not noticeable to customers along the feeder. Full off will normally only occur if the PV inverter senses a problem in the utility supply that requires it to trip or if it is being taken out of service for maintenance or other reasons.

Clouding is not a true flicker event as normally thought of. The individual PV inverters ramp up or down over a finite period of time during clouding. Depending on the physical size of the plant this can take several seconds and for the feeder as a whole, several minutes may pass before the full impact of clouding is realized. As a result, the voltage Variation may not be as noticeable as it would be if the

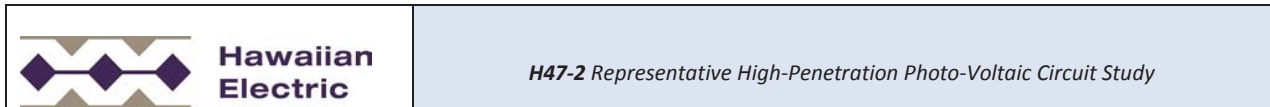

change occurred rapidly. For this review, UCS considered all PV plants on the feeder to change from full on to full off for the initial analysis. If it meets these criteria then Hawaiian Electric Company should not have flicker complaints due to the operation of PV systems. If not, then further evaluation would be necessary.

IEEE 1453¹ provides guidelines for assessment of emission limits for the connection of fluctuating loads. It contains a statistical approach for use with single and multiple fluctuating loads on MV (distribution) or EV (transmission) systems and also includes the impact of distributed generation, such as PV. This method is complex and requires lots of measured data to be of use. The guide also contains a simpler approach using tables and curves that are similar to what utilities have used in the past, such as the flicker curve in Figure 4 Flicker Curves. These can be easily applied for this review.

Table 6 IEEE 1453 ranges for acceptable flicker shows the IEEE 1453 planning guidelines for voltage fluctuations due to fluctuating loads or generators.

Number of changes n	$\Delta U/U_N$ %	
	MV	HV/EHV
n ≤ 4 per day	5-6	3-5
n ≤ 2 per hour and > 4 per day	4	3
2 < n ≤ 10 per hour	3	2,5

Table 6 IEEE 1453 ranges for acceptable flicker

The column labeled “number of changes” represents the expected number of rapid voltage fluctuations during the given time frame. The other columns under the heading “ $\Delta U/ U_N$ ” represent the allowable percent voltage fluctuation at the medium voltage (MV) or distribution level and high voltage (HV) or transmission level of the power delivery system. For this analysis the number of changes is assumed to be less than 4 per day, so a limit of 6% voltage Variation is assumed based on the information in the table. Using the Load-flow model the full on/full off voltage fluctuations were determined for the individual 500kW plants. The worst case showed a voltage fluctuation of less than 1%. The model was also used to determine the largest plant that can be interconnected while meeting the 6% criteria. The worst case would be an installation at the end of the feeder. In this case the plant size that can be interconnected and meet the criteria is 2 MVA.

The next step was to determine if the cumulative impact of all PVs operating in unison. As previously mentioned this is not realistic but it can be used as a guide to determine any limits on PV penetration, due to flicker. In this case a feeder penetration level of 200% was used while at DML. The resulting

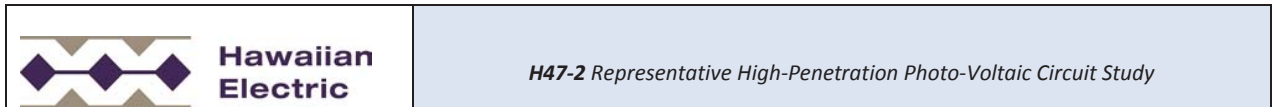

voltage fluctuation was 4.8%. Additional PV generation was added and evenly distributed across the feeder. A Penetration level of over 500% was required to exceed the 6% threshold.

Recommendation for Flicker mitigation

The analysis was made assuming all PV inverters were full on or full off simultaneously. This conservative approach still yielded acceptable levels of voltage fluctuations, per the IEEE 1453 guideline. The analysis was done at 200% penetration. Penetration higher than 500% could yield fluctuations at or above the 6% threshold used here.

Even so, mitigation of flicker or limitations on PV penetration based on flicker limits is not recommended. In reality voltage fluctuations due to clouding is not a true flicker event. The PV generation would ramp down then up across the feeder and not all inverters would vary simultaneously. As a result the voltage Variation would likely not be noticeable to the customers on the feeder. If it should become a problem that is noticeable to customers on the feeder then the ramp rates on the larger inverters can be adjusted to mitigate any flicker.

Implications to H47-2

Based on the analysis, the penetration level would need to exceed 500% (at maximum feeder load of 7MVA) before exceeding the flicker criteria. Other factors will limit PV penetration before a flicker limit is reached.

Application to other feeders

Assuming the typical feeder is similar to H47-2 in terms of these parameters and load levels are similar, then penetrations of 500% should not pose any risk of unacceptable flicker. Since this is not a true flicker event the penetration level could go even higher without causing noticeable voltage fluctuations on the feeder. The impact to LTC operations should be minimal, and can be limited depending on the amount of LDC or other types of control schemes used. As with H47-2, other factors will limit PV penetration before flicker becomes unacceptable.

Temporary Overvoltage (TOV)

Criticality

TOV falls within the Equipment Damage category of Priority of Issues/Concerns. This topic carries a **High Priority** with respect to criticality.

 Hawaiian Electric	<i>H47-2 Representative High-Penetration Photo-Voltaic Circuit Study</i>
--	--

Likelihood of Occurrence or Problems Related To:

Unacceptable TOV is very unlikely with PV below 150% penetration, based on other studies [6]. The potential for unacceptable TOV increases as the penetration level increases above 150%. In this case it requires a sudden interruption of reverse power flow such as inadvertent opening of the substation breaker, resulting in unacceptable levels of TOV.

TOV Review

Temporary overvoltage, TOV, is something that can occur with any power delivery system [6]. It is a situation where the voltage rises above the normal operating voltage for a very brief time. The most severe type of TOV in terms of magnitude and duration results from line to ground faults in a grounded wye distribution system, like the Hawaiian Electric Company system. Equipment standards used by utilities account for these events and ensure failures due to TOV are quite minimal.

The introduction of PV generation onto the distribution feeder adds to the TOV concerns. There is an additional source of fault current that can worsen the TOV resulting from ground faults. Another TOV situation can result from opening the feeder breaker during a reverse power flow condition, when there is no fault on the feeder. Both of these conditions are described in the sections to follow.

Causes of TOV related to PV generation

There are two primary concerns regarding TOV and PV generation. The first is a situation known as neutral point shift. This occurs anytime there is a line to ground fault on the distribution feeder, and can occur whether or not PV generation exists. Figure 1 shows the voltages in relations to each other and to ground both before and during a line to ground fault on the feeder.

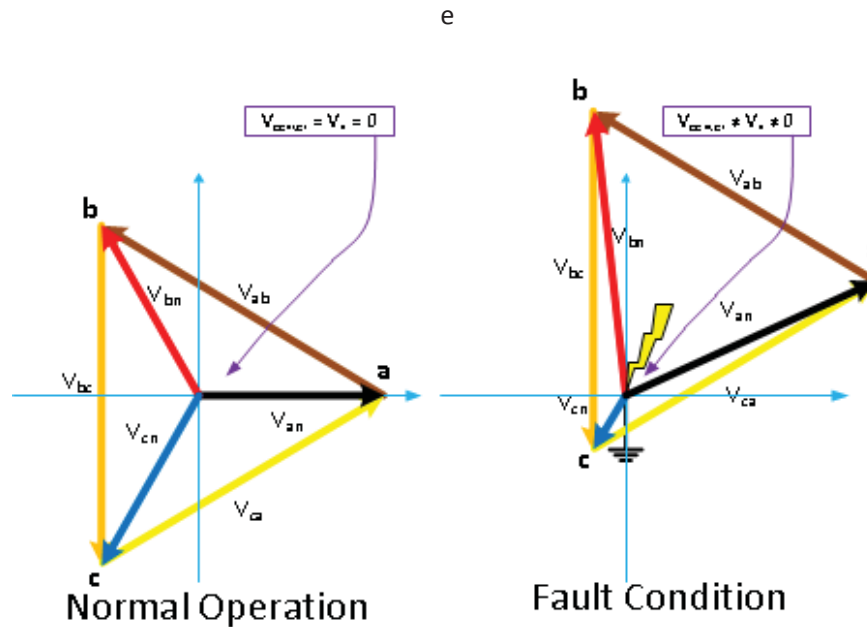

Figure 5 Neutral Shift due to Line-to-Ground Fault

Figure 5 Neutral Shift due to Line-to-Ground Fault is worst case for this situation; the neutral is fully shifted by the magnitude of one of the phase voltages. It can be seen the resulting overvoltage at point “c” or point “a” to ground is the full phase to phase voltage, or 1.73 (square root of 3) times the previous phase to ground voltage. In reality the magnitude of the overvoltage is a function of the impedance path through ground and the magnitude of the fault current so the TOV will be less than 1.73 times the nominal voltage.

The duration of the overvoltage is a function of the relaying time for the protective device that will interrupt the fault. TOV of this nature is taken into consideration when sizing equipment insulation and protective devices such as surge arresters. Due to the low contribution levels of fault current by the PV generation, they do not add an appreciable level of TOV to this condition and, as a result, it is not a primary consideration for this study. In addition the inverters are required to trip upon sensing a phase to ground fault condition on the system so the duration of their contribution is also minimized.

A second type of overvoltage condition related to PV generation is known as load rejection. This occurs when a switch, such as the substation feeder breaker, opens while the PVs are generating and exporting a significant amount of power back to the system. Figure 6 Current Flows Before and During Load Rejection depict the current flow from a PV (I_{pv}) to the load on the feeder (I_{load}) and to or from the system (I_{grid}).

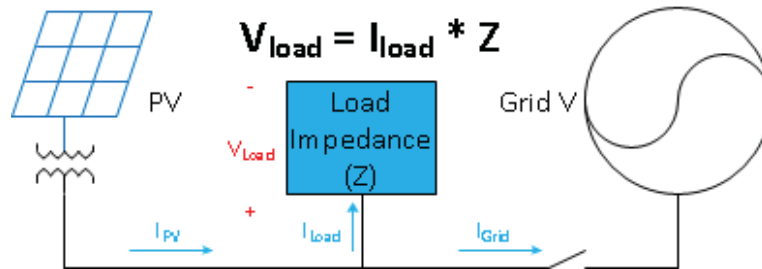



Figure 6 Current Flows Before and During Load Rejection

If the load on the feeder is more than what the PV is generating then I_{grid} flows from the system to the load. If the breaker is opened during this condition the current from the source (the utility grid) is interrupted, the PV will continue to generate for a short time. It will not be able to match the load, will sense the voltage drop and determine it as an interruption and shut down. During this transition there are no adverse voltage conditions on the system or at the customer load. There is a condition that can occur if the load and PV generation are very closely matched at the time of the breaker opening referred to as an unintended island. This is described in more detail in another section but even if an unintended island occurs no TOV condition will be present.

In the case of the PV generation being greater than the feeder load, I_{grid} flows toward the utility source and power will be pushed back onto the system. If the breaker opens during that time, current continues to flow from the PV to the load for a short time just like before. In this case the current, I_{load} becomes equal to I_{pv} and is greater in magnitude than before. As a result, V_{load} increases proportionally since $V_{load} = I_{load} \times Z_{load}$ (the load impedance, which remains constant). This overvoltage condition is temporary in nature and can be greater in magnitude than the neutral shift TOV previously described. If the PV generation to load ratio is sufficiently high then the resulting TOV could be damaging to utility and customer equipment.

As long as the PV generation can be fully absorbed on the feeder there is little or no concern for TOV due to load rejection. As a result PV generation to load ratios of 100% or less will not pose a threat for excessive TOV. Ratios above this can put the system at risk for excessively high TOV. The most sensitive equipment on the utility distribution system in regards to TOV is typically the surge arresters. These are normally sized to withstand TOV levels of 150% [7] of nominal voltage for several seconds. This exceeds the PV shutdown time duration, including any voltage ride through requirements. If this is used as a guide then the total penetration of PV on the feeder connected to the system at the time of breaker opening should not exceed 150%.

 Hawaiian Electric	<i>H47-2 Representative High-Penetration Photo-Voltaic Circuit Study</i>
--	--

Eliminating or mitigating TOV

The following are several methods of minimizing or eliminating TOV that have been incorporated among utilities.

Transfer tripping – This solution only applies to the FIT installations. For this solution the PV inverter controls are given a signal to shut down prior to the feeder breaker opening. This usually applies to larger PV plants on the feeder where communication systems are already in place for remote monitoring and control of the plant. A transfer trip scheme, with high-speed communications between the substation protection system and the individual PV inverter controls, is required to implement this solution. The transfer trip signal can be initiated by the protective relays sensing the need to trip or by anything that results in a breaker opening for other reasons. The communication means used to implement transfer tripping is typically fiber optic or radio.

In addition power line carrier and hard-wired communication can be used. Note this only needs to be performed during a reverse power situation. The relaying and trip scheme should be designed to account for this.

High speed ground switches – For this solution a ground switch is installed at the substation, on the load side of the feeder breaker. When the feeder breaker opens, it initiates closing the ground switch which essentially puts a three-phase to ground fault on the system. This provides a place for any excess current from PV generation to flow while clamping the phase voltages to ground potential and mitigating TOV. Some have included a resistive path to ground for this solution in which case a load is in the path to ground in lieu of a solid fault. Since this transition from breaker open to ground switch closed cannot be made instantaneously there may still be enough TOV rise to exceed desired thresholds. As a result this solution may not prove to be sufficient for every case.

Grounding transformers – One of the issues with the line to ground fault scenario or the breaker opening/load rejection scenario is the loss of the ground reference from the utility supply side. Installing a grounding bank, typically a wye-delta connected transformer across the primary and typically at or near the substation, will provide a ground reference when the PVs become the generation source [7], [8]. This solution only applies to the neutral shift TOV scenario. It does little for the load rejection TOV condition except to maintain a ground reference that is similar to the pre-opening condition.

Limit the PV penetration – Limiting the total PV generation on the feeder is another way of mitigating TOV. This applies to both the neutral shift and load rejection scenarios. Limiting the PV to load ratio to 150% or below will keep the load rejection TOV levels at or below what the system is already designed for. This can be done in two ways. One is to simply limit the sum of all PV, FITs and NEMs, to that

 UC SYNERGETIC <i>Innovative Thinking. Engineered Solutions.</i>	Filename: H47-2_Final.Docx Modified: 2/25/14 Page: 38 of 113
---	---

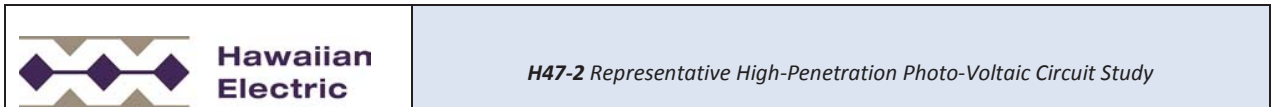

amount. Another is to utilize the transfer trip scheme previously described to remove the larger units (primarily FITs) from the system prior to the breaker opening. In this case the TOV will not limit the amount of PV generation on the feeder until the remaining units exceed 150% of DML.

Voltage sensing and rapid disconnect of the inverters - Some of the inverter manufacturers claim to have devices that will sense a high voltage condition and disconnect rapidly enough to avoid or mitigate TOV. Hawaiian Electric Company can require these for installations where the feeder penetration is above 150% to avoid the potential for TOV problems.

Recommendation for TOV mitigation

Limiting TOV by limiting the PV penetration, in conjunction with the transfer trip option for FITs is a solution that:

- Does not limit the amount of FIT generation integrated on a given feeder.
- Allows for an appreciable amount of NEMs and other PV generation. For many feeders this will allow for a NEM PV on every residence.

The remaining PV generation, after FITs are tripped off prior to opening the feeder breaker, should be at or below 150% of DML. When implementing this solution, Hawaiian Electric Company should closely monitor the feeder load and FIT generation to determine the margin that remains for NEM installations.

If penetration levels above this are desired then Hawaiian Electric Company will need to require any PV inverters installed to have a fast trip device that can sense a high voltage condition and disconnect rapidly enough to avoid excessive TOV.

Implications to H47-2

According to the data provided to UCS the penetration on this feeder is already at a level where reverse power flow can occur and in excess of 150%. Unless recommended measures are taken there may be a risk of excessive TOV.

Application to other feeders

Many of the feeders on the Hawaiian Electric Company system are currently not at the penetration levels to be at risk for TOV above design guidelines. However, as penetration levels rise the recommended solution should be implemented to ensure risk of unacceptable TOV is not incurred.

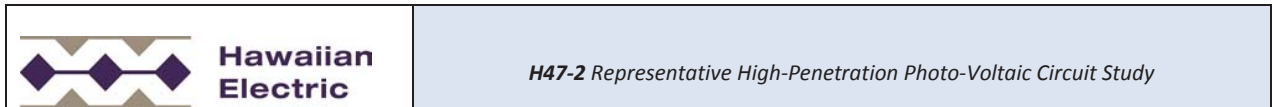

Unintended Islands

Criticality

Unintended Islands fall within the Safety category of Priority of Issues/Concerns. This topic carries a Very **High Priority** with respect to criticality.

Likelihood of Occurrence or Problems Related To:

Above 85% penetration there is an intermediate chance for and unintended island to form.⁴

Unintended Island Review

Inverters that are UL 1741 and IEEE 1547 compliant are tested to separate from the grid with the loss of the utility source.

IEEE 1547 CL 4.4.1 Unintentional islanding

For an unintended island in which the DR energizes a portion of the Area EPS through the PCC, the DR interconnection system shall detect the island and cease to energize the Area EPS within two seconds of the formation of an island.

Some examples by which this requirement may be met are:

1. The DR aggregate capacity is less than one-third of the minimum load of the Local EPS.
2. The DR is certified to pass an applicable non-islanding test.
3. The DR installation contains reverse or minimum power flow protection, sensed between the Point of DR Connection and the PCC, which will disconnect or isolate the DR if power flow from the Area EPS to the Local EPS reverses or falls below a set threshold.
4. The DR contains other non-islanding means, such as a) forced frequency or voltage shifting, b) transfer trip, or c) governor and excitation controls that maintain constant power and constant power factor.”

10 kW and 100 kW customers will fall under the category where DR aggregated capacity is less than one-third of the minimum load of the local EPS. On top of it, if those inverters are 1547 certified there

⁴ The existing Hawaiian Electric Guideline of allowing 100% penetration opens the door to possible unintended island formation. It is presumed that Hawaiian Electric has operating procedures in place to ensure the safety of the Hawaiian Electric construction and maintenance crews.

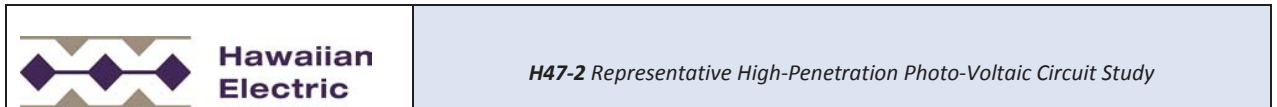

shouldn't be an issue per above guidelines. However, with penetration levels of PV above 85% penetration there is some opportunity, while remote, for unintended islands to form which poses a safety issue to workers.

Implications to H47-2

- Operating procedures need to be in place to protect workers
 - Check for voltage before work
 - Hang grounds before work
 - Wear appropriate Personal Protective Equipment
- Installing a grounding switch at the substation when the breaker opens can add an extra level of protection for workers

Application to other feeders

- Operating procedures need to be in place to protect workers
 - Check for voltage before work
 - Hang grounds before work
 - Wear appropriate Personal Protective Equipment
- Installing a grounding switch at the substation when the breaker opens can add an extra level of protection for workers

Harmonics

Criticality

Harmonics falls within the Equipment Damage category of Priority of Issues/Concerns. This topic carries a **High Priority** with respect to criticality.

Likelihood of Occurrence or Problems Related To:

Harmonic issues are unlikely at any penetration level of PV.

Harmonic Review

The inverters that convert the DC to AC in a PV system introduce additional harmonics onto the distribution system. There are already harmonic sources on the system due to nonlinear loads such as power supplies, Variable speed drives, electronic ballasts for lighting, and computers, among other sources [9]. Equipment manufacturers adhere to industry standards for harmonic output and, in

general, this prevents any issues related to harmonics on the power system. Problems that do arise will result in equipment overheating and overvoltage conditions that can lead to equipment failure [10].

Harmonics become problematic when the system has both a harmonic source and circuit impedance with which the harmonic frequencies can resonate. There are two forms of resonance that can occur, series and parallel [11]. These circuit resonant frequencies are primarily due to the interaction between capacitive reactance of power factor correction capacitors and overhead line inductive reactance or substation transformer reactance.

Series resonance is first described here. Figure 7 Simplified One-Line Depicting Series Resonance shows a simplified diagram of a harmonic source, such as a PV inverter, the line impedance and a shunt capacitor. The red line shows the series current path from the harmonic source through the capacitor bank.

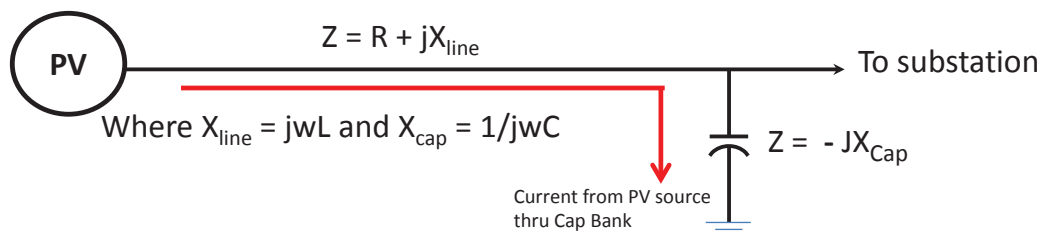

Figure 7 Simplified One-Line Depicting Series Resonance

It can be seen if $X_{line} = X_{cap}$ the impedances cancel each other (the capacitive reactance is shown as negative with reference to the line inductive reactance) and a condition exists where the path from the PV to ground through the capacitor bank is limited by R only. This is known as series resonance. High currents would flow, at the harmonic order where resonance occurs, and the high current flowing in series through the capacitor will also result in high voltage. These high currents can result in blown capacitor bank fuses and the high voltage can damage equipment or result in blown surge arrestors.

Figure 8 Simplified One-Line Depicting Parallel Resonance depicts the parallel resonance condition. In this case the resonant condition occurs between the capacitor bank and the substation transformer. It is more likely with situations where a capacitor bank is in close proximity to the substation transformer.

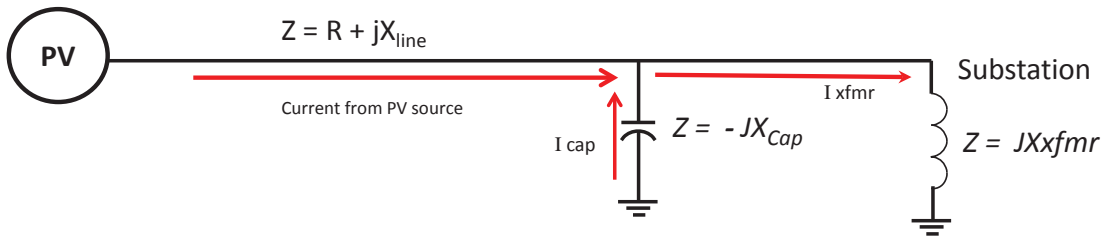

Figure 8 Simplified One-Line Depicting Parallel Resonance

If the magnitude of $X_{cap} = X_{xfmr}$ then the impedance of the parallel combination appears infinite to the harmonic source where resonance occurs. Remember, for a parallel combination of impedances you multiply them together then divide by the sum of the two. In this case the sum of the two is zero since they are equal and opposite in value. In this case high currents at the harmonic order of resonance will flow in the loop between the capacitor and transformer winding. This can also result in damaging voltages and excessive currents.

Typically the conditions rarely exist with 60 cycle currents to result in resonance between these elements in a distribution system. When analyzing for harmonic resonance conditions related to PV system, the harmonic content of the 2nd, 3rd, 5th and 7th order are of particular interest [12] as these are predominant in the output from the PV inverters.

Analysis tools are available to assist in determining harmonic resonance points on the system [13]. Accurate analysis on a distribution feeder is difficult because:

- The harmonic output spectrum Varies among inverter manufacturers, making modeling of the harmonic sources difficult. The harmonic output also Varies with the level of generation.
- The software does not account for the cancellation effect previously mentioned. As a result, the analysis will show things worse than they really are. With the high number of NEMs on the H47-2 feeder there should be a lot of cancellation so the levels harmonics are likely much lower that what an analysis would show.
- The system is very dynamic in nature due to changes in load, Variations in impedance, Variations in generation, etc.
- In many cases all components of the feeder are not modeled and even if they are, the values are approximations in many cases. For example when service transformers are modeled impedance is assumed. The actual impedance value can vary greatly. The same holds true for the PV step up transformer.

Software was used to perform a harmonic analysis. The FIT at location K_TAP8B1 was used as the harmonic source and default values for the harmonic spectrum were assumed in the software. Figure 9

 <p>Hawaiian Electric</p>	<p><i>H47-2 Representative High-Penetration Photo-Voltaic Circuit Study</i></p>
---	---

Harmonic Analysis Results shows the results of interaction between the FIT and the 3600 kvar substation capacitor bank.

The results show a potential parallel resonant point, indicated by the impedance “peak” at around the 4th harmonic and a series resonant point, indicated by the “valley” at the 6th harmonic. The inverter output for the 4th harmonic is less than 0.6% distortion and for the 6th harmonic is only 0.1%. At these levels the resulting impact to the system is minimal. Note the harmonic currents are limited by the step up transformer and line resistances even though resonance is achieved. In addition the capacitor ratings account for a normal amount of harmonic currents (generally less than 5% distortion) so this will not pose as a problem to their operation.

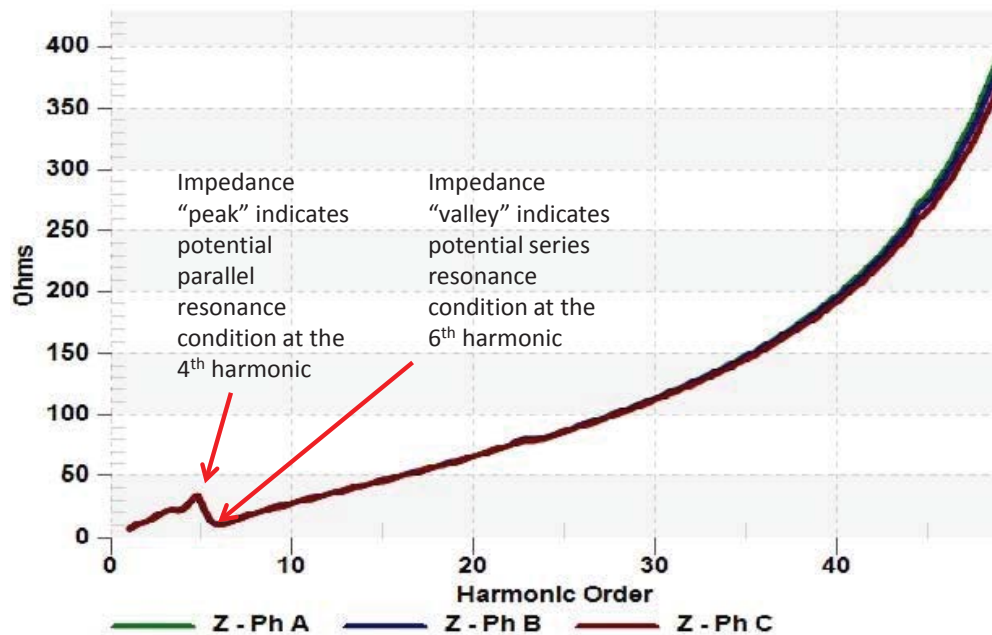



Figure 9 Harmonic Analysis Results

In order to show the impact of using a smaller capacitor bank the 3600 kvar bank was changed to 1800 kvar. Figure 10 1800 kvar Capacitor Bank at Substation shows the results of that frequency scan.

 Hawaiian Electric	<i>H47-2 Representative High-Penetration Photo-Voltaic Circuit Study</i>
--	--

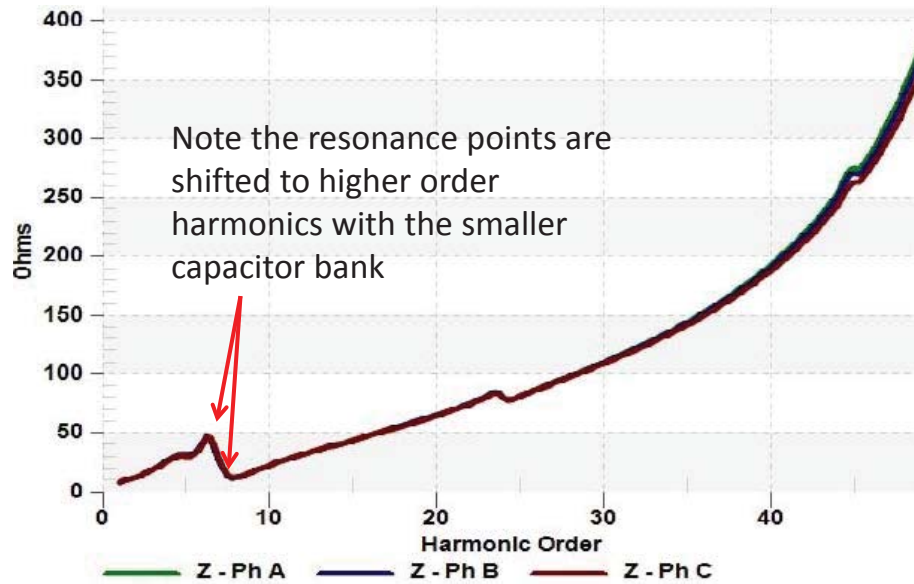



Figure 10 1800 kvar Capacitor Bank at Substation

It can be seen that decreasing the capacitor size pushes the resonant point further out on the frequency spectrum. In this case the parallel resonant point is at the 6th harmonic and the series point is at the 8th harmonic. The distortion at these harmonic orders is 0.1% or below so they pose no threat to the system.

A 450 kvar line capacitor was added to the model for volt/var correction purposes during the steady state analysis. This introduces more potential resonance points on the feeder and Figure 11 Frequency Results with 450 kvar Capacitor Bank Addition shows this.

 Hawaiian Electric	<i>H47-2 Representative High-Penetration Photo-Voltaic Circuit Study</i>
--	--

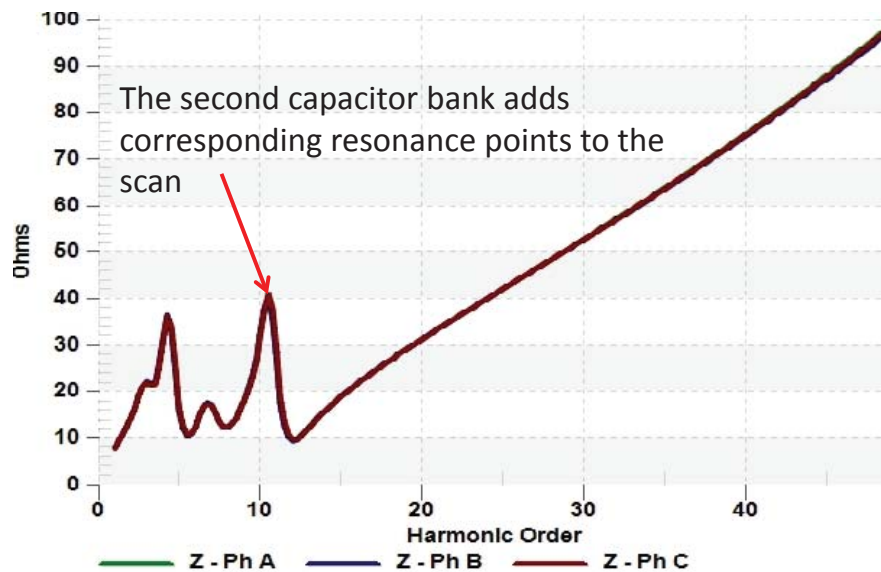



Figure 11 Frequency Results with 450 kvar Capacitor Bank Addition

Several other observations can be made from these results.

- The larger the capacitor bank, the lower the resonant harmonic frequency order where resonance can potentially occur.
- Conversely, smaller banks result in resonance points that are at higher harmonics. The harmonic distortion at these higher orders is low with PV inverters so resonance will not be an issue.
- Each capacitor bank will introduce separate potential resonance points [14].
- The capacitor bank sizes typically used for line applications are small (1200 kvar and below) compared to what is required to create resonance points at lower order harmonics. As a result, they pose little risk for series or parallel resonance conditions that impact system operations.

In addition, the current and voltage distortion at the point of interconnection should be within the IEEE-519 standard's specified limits, as in Table 7 IEEE 519 Harmonic Voltage Distortion limits and Table 8 IEEE 519 Harmonic Current Distortion limits. As long as the inverter manufacturers meet UL 1741 requirements the harmonic voltage and current distortion on the feeder should be within the shown in the tables. The total harmonic distortion, THD, is a measure of the percentage which harmonics make up the total output.

Harmonic Voltage Distortion in % at PCC (substation in this case)			
	2.3 - 69 kV	69 - 161 kV	> 161 kV

	Filename: H47-2_Final.Docx Modified: 2/25/14 Page: 46 of 113
---	---

 Hawaiian Electric	<i>H47-2 Representative High-Penetration Photo-Voltaic Circuit Study</i>
--	--

Maximum for Individual Harmonic	3.0	1.5	1.0
Total Harmonic Distortion (THD)	5.0	2.5	1.5

Table 7 IEEE 519 Harmonic Voltage Distortion limits

Harmonic Current Distortion in % at PCC (substation in this case)			
Ranges of harmonic order	h < 11	11 < h < 17	17 < h < 23
For I _{load} /I _{sc} ratio less than 20 (H47-2)	4.0	2.0	1.5

Table 8 IEEE 519 Harmonic Current Distortion limits

The voltage THD at the substation with all FITs in operation was less than 1%. The current THD was below 2%. These values are well within the standards and based on the analysis there should be no harmonic issues with HPPV. With multiple harmonic sources there is also something known as harmonic cancellation [15], [16]. The harmonic currents are vectors and have a magnitude and an angle. The magnitudes from two different harmonic sources may be identical but the angles can be quite different so the summation of the two can be less than when simply adding the magnitudes. Because of this cancellation the combination of multiple harmonic sources will generally have less of an impact on the system than a single source.

Implications to H47-2

Harmonics due to the PV inverter sources should not be a problem with the H47-2 feeder, even after the addition of var compensation capacitor banks. The capacitors create a harmonic resonance point where high voltage or excessive currents could present a problem. In the case of H47-2 these resonance points involve harmonic orders that are not prevalent or of high enough magnitude to create such problems.

Application to other feeders

As with H47-2, there should be little or no risk of harmonic issues due to the PV inverter sources. High penetration levels will not present added risk. As line capacitors are added for volt/var correction on the feeders, these will add little or no risk of harmonic resonance. In addition, harmonic cancellation will reduce the risk of adverse impacts of HPPV.

 <i>Innovative Thinking. Engineered Solutions.</i>	Filename: H47-2_Final.Docx Modified: 2/25/14 Page: 47 of 113
--	--

 Hawaiian Electric	<i>H47-2 Representative High-Penetration Photo-Voltaic Circuit Study</i>
--	--

Harmonics are difficult to study analytically due to the issues previously stated. As a result, measurements should be taken on select feeders with the highest penetration levels to ensure harmonics do not pose a threat to the system.

LPV Plot Study

Solar Penetration also known as the Minimum Load to Generation Ratio (MLGR) is a metric often used in reviewing ground fault overvoltage potential and the potential for unintended islanding. It describes the maximum generation of the PV at a time of peak solar irradiation, typically around noon time, to the minimum feeder load. The ratio is quite useful in getting a general sense of certain risks. However, by using the peak solar generation and the minimum daytime load it tends to be conservative and gives very little depth in understanding of what is going on when dealing with HPPV feeders. For greater understanding of the behavior of the relationship of feeder load to feeder based PV generation Load-to-PV (LPV) Plots are used.

LPV Plots

The Various limitations such as TOV, unintended islanding, reverse power, etc. are dependent on the Load to PV generation ratio. The Load to PV generation ratio for each hour of the day can be plotted as a “LPV Curve”. The Load to PV generation ratio, LPV Curves, can vary greatly hour to hour and day to day. The “LPV Box” represents all combinations of LPV Curves that can occur throughout the year, based on an annual generation and load cycle. If the LPV Box does not violate any of the thresholds for various adverse conditions, then the exposure risks are minimal. If the LPV Box does violate any of the thresholds, then there is additional exposure risk incurred and mitigation techniques should be employed.

Unintended Islands

The chance for unintended islanding occurs at around an even match between load and generation. In other words when there is 1 to 1 match between load and generation there is a chance for unintended islanding. On the LPV Plot a 1:1 line is a line with a slope of 1. To add some margin of safety the criteria slightly two lines are used defining a zone of potential islanding, one with a 0.85 slope and another with a 1.15 slope. This gives a range of +/- 15% match between load and generation.

Ground-fault Overvoltage (TOV)

Ground fault over voltage occurs when a single line to ground fault leads to an over voltage condition on the un-faulted phases. This overvoltage can be as much as $\sqrt{3}$ times the un-faulted voltage. A guideline for screening for Suppression Analysis for Ground Fault Overvoltage is a MLGR of 3. [3] In the LPV Plot this represents a line with a slope of 3.

 <p>UC SYNERGETIC <i>Innovative Thinking. Engineered Solutions.</i></p>	<p>Filename: H47-2_Final.Docx Modified: 2/25/14 Page: 48 of 113</p>
---	---

 Hawaiian Electric	<i>H47-2 Representative High-Penetration Photo-Voltaic Circuit Study</i>
--	--

Load Rejection TOV

Load Rejection TOV occurs when a switch, such as the substation feeder breaker, opens while the PVs are generating and exporting a significant amount of power back to the system. It is a situation where the voltage can rise above the normal operating voltage for a very brief time. A guideline for screening for Load Rejection TOV is a MLGR of 1.5. [3] In the LPV Plot this represents a line with a slope of 1.5.

Reverse Overload (thermal capacity limit)

A reverse overload, also referred to as thermal capacity limit, occurs when there is sufficient solar generation on the feeder to lead to enough reverse power flow on the feeder such that the wire reaches a thermal overload from current flowing in the reverse direction. In this case the line in the LPV Plot that shows the reverse overload limitation has a slope of 1, but has a y intercept of 7 MVA. The slope intercept of 7 MVA describes a condition where a feeder has 7 MVA of generation with no load. This is for a feeder that has a 7 MVA allowable thermal limit. [17] Using the Allowable loading limit allows for single contingencies of circuits that have two feeder ties where all circuits involved have an emergency loading limit of approximately 600A.

Voltage Regulation

Older regulator controllers and LTC controllers were designed from the perspective of power flowing down the circuit from the substation. If these older regulators experience reverse power flow then there is a tendency for the regulator, if called on to regulate voltage, to regulate in the opposite direction from what is needed. When a tap rise is needed the regulator will call for a lower when experiencing reverse flow.

Newer controllers have a co-generation mode available to correct for the inability of older controllers to regulate properly in the presence of reverse power due to distributed generation. In circumstances where there is reverse flow on the LTC and/or voltage regulator due to penetration levels above 100% penetration it is necessary for the LTC controller to be switched to co-generation mode. If such a mode is not available for the existing controller it is advisable to replace the controller with one that has co-generation mode once the circuit or substation approaches 100% penetration.

Implications to H47-2

- 100% Penetration: Increased risk for Unintended Islands (safety concern)

 UC SYNERGETIC <i>Innovative Thinking. Engineered Solutions.</i>	Filename: H47-2_Final.Docx Modified: 2/25/14 Page: 49 of 113
---	--



H47-2 Representative High-Penetration Photo-Voltaic Circuit Study

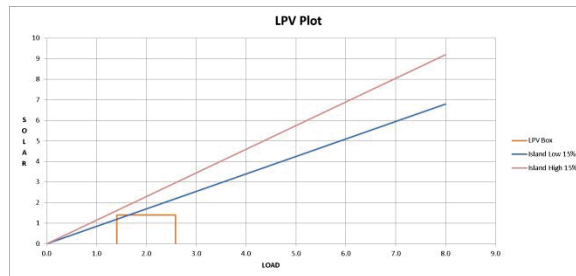

-
- 110% Penetration: Increased risk for Reverse flow (equipment operation concern)

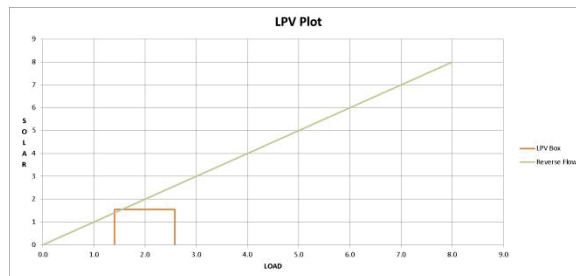

-
- 170% Penetration: Increased risk for TOV due to Load-Rejection (equipment damage concerns)

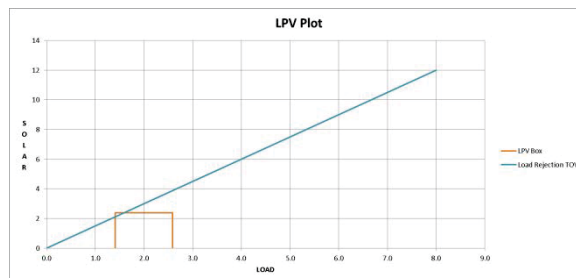

-
- 330% Penetration: Increased risk for TOV due to Line-to-ground fault (equipment damage concerns)

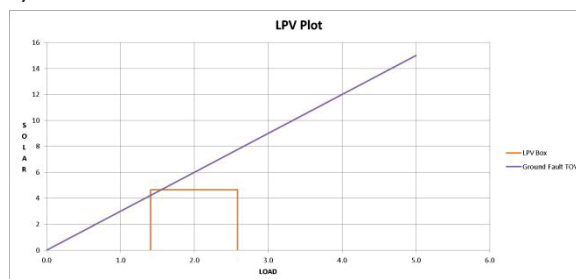

-
- 630% Penetration: Increased risk for Reverse Overload (equipment damage concern)

	<p>Hawaiian Electric</p>	<p><i>H47-2 Representative High-Penetration Photo-Voltaic Circuit Study</i></p>
---	---------------------------------	---

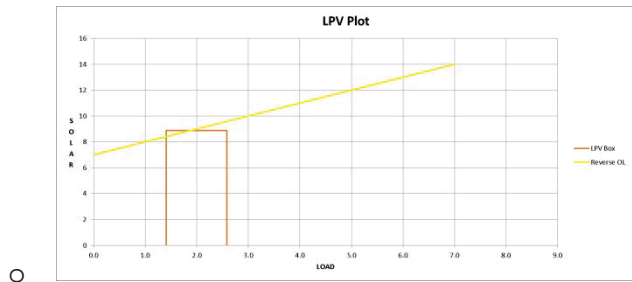

Application to other feeders

- 100% Penetration: Increased risk for Unintended Islands (safety concern)

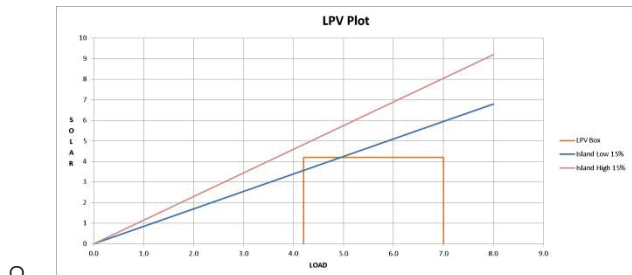

- 110% Penetration: Increased risk for Reverse flow (equipment operation concern)

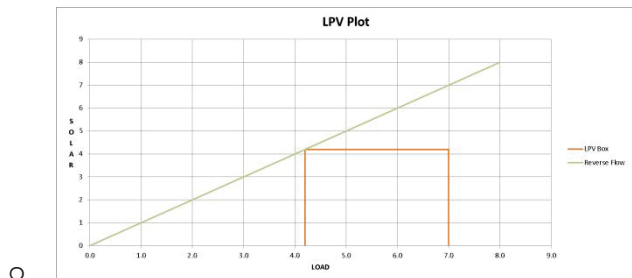

- 170% Penetration: Increased risk for TOV due to Load-Rejection (equipment damage concerns)

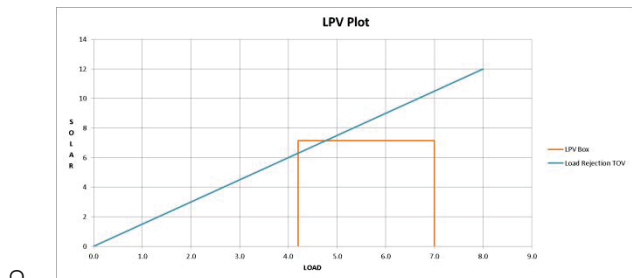

- 290% Penetration: Increased risk for Reverse Overload (equipment damage concern)

 <p>Hawaiian Electric</p>	<p><i>H47-2 Representative High-Penetration Photo-Voltaic Circuit Study</i></p>
---	---

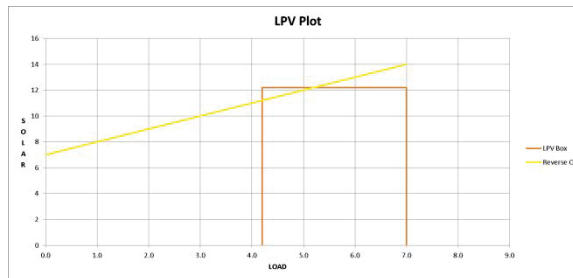

-
- 330% Penetration: Increased risk for TOV due to Line-to-ground fault (equipment damage concerns)

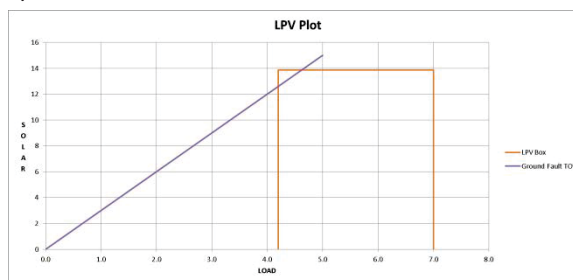

LPV Plot Findings for the H47-2 Circuit

The H47-2 circuit was evaluated under the circuit conditions at the time of the study.

- 2583 kW Peak Load
- 1407 kW DML
- 7 MVA is used as the thermal limit in the LPV calculations [17]
- 700% Penetration: Increased risk for Reverse Overload (equipment damage concern)

LPV Plot Findings Generalized for the Hawaiian Electric Company System

In order to generalize the findings from LPV Plots to be applicable to similar circuits throughout the Hawaiian Electric Company System, a peak feeder load and DLR are assumed based on the following:

- Feeder peak load
 - Allowable circuit ampacity of 360 A is used for thermal circuit loading [17]
 - Feeder voltage = 11.5 kV or 12.5 kV
 - $360 * 11.5 \text{ kV} * \sqrt{3} = 7170 \text{ kVA}$
 - $360 * 12.5 \text{ kV} * \sqrt{3} = 7794 \text{ kVA}$
- 7 MVA is used as the thermal limit in the LPV calculations

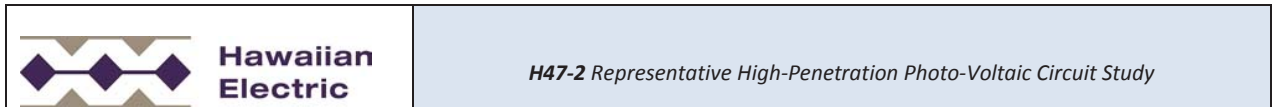

- DLR
 - 40% is the standard value used by Distribution planning when no other data is available⁵
 - H47-2 has a moderate amount of commercial load and its DLR is approx. 55%
 - To accommodate circuits with higher levels of commercial and/or industrial load a DLR of 60% is used for the Generalized LPV analysis.
 - NOTE: some circuits that have heavy concentrations of commercial and/or industrial load may have DLR values greater than 60%. Care must be taken for circuits with high concentrations of commercial and/or industrial loads as the following values may be too liberal for such situations.

Summary and Recommendations

The goal of this study was to identify the risks and/or limitations of accepting more PV generation interconnections onto the H47-2 circuit. The H47-2 circuit was selected as a representative feeder, with the intent of extrapolating results of this study to other similar feeders. Caution must be exercised when applying results of this study to other feeders. The following issues were analyzed for this study:

1. Steady State impacts to voltage (including regulation) and equipment loading
2. Protection – relay, recloser and fuse coordination
3. Voltage Flicker – short duration voltage fluctuations that are noticeable to customers
4. Temporary overvoltage (TOV) – a short duration high voltage condition
5. Unintended Islanding – a condition where the inverters remain in service when the supply feeder trips
6. Harmonics – these are a product of generation with electronic power conversion equipment. Excessively high levels can be detrimental to equipment overheating and other operational issues.

The following assumptions were made for the analysis:

- Existing and known FIT locations were used.
- When adding PV generation to the above, an even distribution was assumed.
- Existing loads are balanced within 10% among the phases.

⁵ HECO Distribution Planning department data indicates that DML is approximately 40% of peak feeder load.

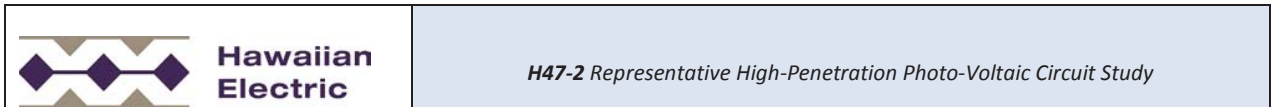

- FITs can operate between delivering 0.95 power factor vars and 0.99 power factor absorbing vars.
- The loads operate at 0.90 power factor absorbing vars.

Factors that limit PV penetration

Thus far the focus in the industry about how much PV to allow on a circuit has centered on penetration level. For this study the findings are reported in penetration level as a percent of the daily minimum load (DML). While penetration limit is a primary factor in evaluating how much PV can be added to a distribution circuit without issue, it is not the only factor. This is particularly true in the case of high penetration PV (HPPV) where the penetration levels are approaching and/or exceeding 100% of Day-time Minimum Load. This study has found the following factors to have significant influence in limitations:

- Day-time Minimum Load (DML)
 - The minimum load on a circuit during the daytime hours (9am-5pm) over a calendar year.
- % Penetration based on DML
 - PV generation divided by the load, expressed as a percent.
- Circuit Peak Load (Pk)
 - The maximum load on a circuit over a calendar year.
- Daytime Load Ratio
 - The ratio of Daytime Minimum Load to Peak Load.

It is believed, while not yet entirely verified, that additional factors may have influence on the ultimate limits and should be studied further which include:

- Circuit load phase balance
 - The amount of load on the highest loaded phase vs the average phase loading
- Circuit PV phase balance
 - The amount of PV on the highest PV penetration phase vs the average phase PV penetration
- Circuit lateral PV penetration balance
 - The penetration of PV on one lateral vs that of another on the same circuit
- Circuit PV penetration balance
 - The penetration of PV on one circuit vs that of another fed from the same LTC/Transformer

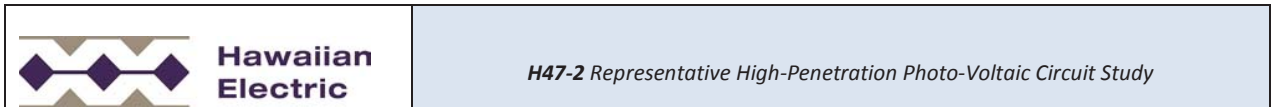

- Transformer PV penetration
 - The PV penetration limit of the substation transformer and LTC
- Sub-transmission PV penetration
 - The PV penetration limit of the sub-transmission system

Limitations on PV Penetration

The reverse power overload condition is a limitation that cannot be mitigated. As a result, this is the ultimate limit for PV penetration on a distribution feeder. Assuming 7MVA peak allowable load capacity, the penetration limit was shown to be 290%. This equates to about 8 MVA of PV generation. This amount of generation accommodates single contingency load switching capability when the 7 MVA allowable loading limit applies and is respected. This assumes the possibility of TOV during sudden interruption of exporting power has been mitigated as recommended in the section on TOV via transfer trip schemes with the FITs or with rapid sensing/disconnect devices on the inverter controls including the NEMs. It also assumes a protection review is conducted and device settings and sizes are revised as necessary to accommodate the FITs. The following are other issues to consider as the PV generation begins to exceed the feeder load:

- 100% Penetration: Increased risk for Unintended Islands (safety concern)
 - Operating procedures need to be in place to protect workers
 - Installing a grounding switch at the substation when the breaker opens can add an extra level of protection for workers
- 110% Penetration: Increased risk for Reverse flow (equipment operation concern)
 - The LTC needs to have a controller that has co-generation mode.
 - The LTC needs it's controller set to co-generation mode.
- 150% NEM Penetration: Increased risk for TOV due to Load-Rejection (equipment damage concerns)
 - Ensure inverters have capability for rapid response to high voltage conditions due to TOV.
 - Or, limit NEM penetration to 150% of DML and install transfer trip schemes on the FIT installations.

The maximum PV expressed in percent of DML will change with feeder load, but the maximum that can be installed is still 8 MVA. This accounts for up to 10% load imbalance and imbalance in PV distribution, and DLR values within 10 percentage points of the assumed 60% ratio. Any large variations from these assumptions will require additional study. For example some circuits that have heavy concentrations of

 Hawaiian Electric	<i>H47-2 Representative High-Penetration Photo-Voltaic Circuit Study</i>
--	--

commercial and/or industrial load may have DLR values greater than 60%. Care must be taken for circuits with high concentrations of commercial and/or industrial loads as the following values may be too liberal for such situations.

Overall Levels of Concern for HPPV on Distribution Feeders

Table 9 Overall Levels of Concern, shows the likelihood of occurrence along with the criticality of each item that may be of concern for HPPV. Red cells are of very high concern, orange cells are of high concern, yellow cells are of intermediate concern, and green cells are of little or no concern.

Levels of Overall Concern		Likelihood of Occurrence or Problems Related To		
		<i>Highly Likely</i>	<i>Intermediate Likeliness</i>	<i>Unlikely</i>
Criticality	<i>Very High Priority</i>		Unintended Islands	
	<i>High Priority</i>	Voltage Problems		TOV Protection
	<i>Intermediate Priority</i>		Overload Problems	Harmonics
	<i>Moderate Priority</i>			Flicker

Table 9 Overall Levels of Concern

There are no issues that are highly likely and also of very high priority. Unintentional islanding is the only issue that cannot be totally avoided or mitigated, once 100% penetration is achieved. Even so, it does not present a safety concern to the customers. Safe work practices must be used to ensure utility workers are aware the feeder could remain energized under certain conditions even after the feeder breaker is open.

Bibliography

[1] UC Synergetic, "Addendum to H47-2 Representative High-Penetration Photo-Voltaic Circuit Study:

	Filename: H47-2_Final.Docx Modified: 2/25/14 Page: 56 of 113
---	--

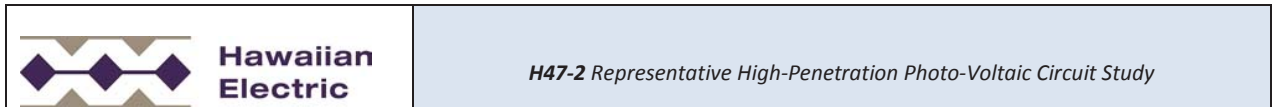

Concerns & Assumptions," UC Synergetic, Raleigh, NC, 2014.

- [2] IEC, *IEC 61000-3-2*, IEC.
- [3] P. Barker, "Experiences in Integrating PV and Other DG to the Power System," in *Utility Wind Interest Group (UWIG) 6th Annual Distributed Wind/Solar Interconnection Workshop*, Golden, CO, 2012.
- [4] R. Ueda, *HECO Distribution Planning department has indicated that their evaluation of DML has indicated that DML is approximately 40% of peak for typical HECO feeders.*, HECO, 2013.
- [5] IEEE, *Adoption of IEC/TR 61000-3-7:2008, Electromagnetic compatibility (EMC)—Limits—Assessment of emission limits for the connection of fluctuating installations to MV, HV and EHV power systems*, 2011.
- [6] Y. W. W. X. Janak R. Acharya, "Temporary overvoltage and GPR characteristics of distribution feeders with multigrounded neutral," *IEEE Transactions*, vol. 25, no. 2, pp. 1036-1044, 2010.
- [7] P. D. S. S. C. M.E. Ropp, "Temporary Overvoltage issues in Distribution Connected PV Systems and Mitigation Strategies," in *Proceedings of the 47th Minnesota Power Systems Conference*, St Paul, 2011.
- [8] O. B. E. C. C. B. W. D. T. S. T. S. M. R. B. R. W. M. Brandt, "Wind power plant grounding, overvoltage protection, and insulation coordination," *IEEE PES collector system working group*, 2011.
- [9] IEEE 519, *Recommended practices and requirements for Harmonic Control in Electrical Power Systems*, IEEE, 1992.
- [10] S. T. B. O. M. Davudi, "Analysis of Harmonics and Harmonic Mitigation methods in Distribution systems," *Australian Journal of Basic and Applied Sciences*, vol. 5, no. 11, pp. 996-1005, 2011.
- [11] S. R. a. W. Xu, "An overview of harmonics modeling and simulation.," *IEEE Task Force on Harmonics Modeling and Simulation*, p. 1, 2007.
- [12] P. M. Z.-M. Soonwook Hong, "Harmonics and noise in PV inverter and the mitigation strategies," *Solectria Renewables White Paper*, 2012.

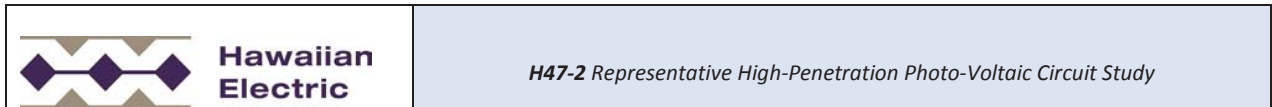

- [13] P. F. R. J. S. Mark Halpin, "Frequency-Domain Harmonic Analysis Methods.," *IEEE Power Engineering Society: Tutorial in Harmonics Modeling and Simulation*, pp. 49-54, 1998.
- [14] B. B. E. C. D. M. J. S. T. S. T. S. M. S. R. W. M. Brandt, "Harmonics and resonance issues in wind power plants.," in *Transmission and Distribution Conference and Exposition (T&D)*, Orlando, 2012.
- [15] Controlled Power Company, *Controlled Power Company application guidelines – Ultra K – UK#23, Phase shifting for harmonic cancellation*, Controlled Power Company, July 1999.
- [16] R. A. O. J. J. a. R. P. B. Arghandeh, "Harmonic interactions of multiple distributed energy resources in power distribution networks.," *Electric Power Systems Research*, vol. 105, pp. 124-133, 2013.
- [17] UC Synergetic, *Allowable Loading.pptx*, Raleigh: UC Synergetic, 2013.
- [18] U. Synergetic, "LPV_Plot.xlsx," UC Synergetic, Raleigh, NC, 2013.

 Hawaiian Electric	<i>H47-2 Representative High-Penetration Photo-Voltaic Circuit Study</i>
--	--

Appendix A – Recommendations for Further Investigation

It is important to note that this representative study is limited to distribution 12 kV class feeder level PV penetration. The impact of HPPV at the transmission and generation level must also be considered. To say that a penetration level of 300% is achievable on a similar feeder does not address the potential for adverse impacts at the sub-transmission or transmission system level. There may be significant impacts from:

- Electrically long feeders should be specifically studied to verify HPPV does not lead to voltage violations⁶.
- Circuit load phase balance
- Circuit PV phase balance
- Circuit lateral PV penetration balance for laterals on the same circuit
- Circuit PV penetration balance for circuits originating from the same LTC/Transformer
- Transformer PV penetration
- Sub-transmission PV penetration
- Penetration at the service transformer level

These factors may further limit the amount of PV that can be accepted on a given feeder. More analysis should be performed to better determine the penetration levels that can be accommodated on each sub-transmission line, substation transformer, feeder and service transformer.

It would also be valuable to perform an hourly load flow of a feeder for an entire year (8760 hours) to gain a clearer understanding of the behavior of HPPV on the Hawaiian Electric Company system.

Generation and transmission impacts must be reviewed well before a penetration level of 300% becomes a reality on a growing number of distribution feeders. Further study is required to determine these limits and should include impacts to normal and emergency loading, system voltages (steady state and transient) and switching and operating actions. Also, a review of Hawaiian Electric transmission planning standards and operating practices is recommended. This would be done in comparison to NERC standards. Although Hawaiian Electric is not bound by these standards, they provide established guidelines for comparison. This can be used to demonstrate to the public and the commission why certain interconnections cannot be accepted without the requisite capital infrastructure investment to maintain reliability margins and operating performance.

⁶ Electrically long feeders could mean significant amounts of impedance between the end of the feeder backbone and the station, which can be physically long lines or high impedance wire or the combination of low voltage lines with high impedance wire.

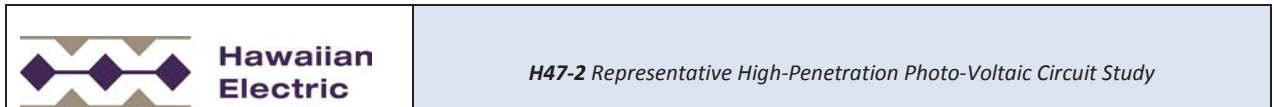

Harmonics are difficult to study analytically for Hawaiian Electric Company's case due to the limitations of data, limitations of software, lack of sufficiently accurate power system analysis models, and lack of industry standards that appropriately apply to single phase roof-top HPPV. As a result, measurements should be taken on select feeders with the highest penetration levels to ensure harmonics do not pose a threat to the system.

 Hawaiian Electric	<i>H47-2 Representative High-Penetration Photo-Voltaic Circuit Study</i>
--	--

Appendix B – Load to Generation (LPV) Plots

Solar Penetration also known as the Minimum Load to Generation Ratio (MLGR) is a metric often used in reviewing ground fault overvoltage potential and the potential for unintended islanding. It describes the maximum generation of the PV at a time of peak solar irradiation, typically around noon time, to the minimum feeder load. The ratio is quite useful in getting a general sense of certain risks. However, by using the peak solar generation and the minimum daytime load it tends to be conservative and gives very little depth in understanding of what is going on when dealing with HPPV feeders. For greater understanding of the behavior of the relationship of feeder load to feeder based PV generation Load-to-PV (LPV) Plots are used.

As a foundation to understanding LPV plots some understanding of load curves and solar generation curves is necessary.

Load Curve

A load curve is a plot of the feeder load over a 24 hour period. The x-axis of the curve is the hour of the day and the y-axis of the curve is the feeder load. The load readings are often marked off in hours, but higher resolution data can be plotted in the same way. Figure 12 Feeder Load Curve shows a typical load profile. This load shape is fairly typical of circuits which have a high concentration of residential customers. A “residential” circuit load profile often has a minimum load around 2-3 am in the morning the load grows in the morning to reach a morning peak around 8-9 am. After the morning peak there is often a plateau or a slight drop in load in the mid-day. The load then grows to the feeder peak at around 5-6 pm. After the evening peak the feeder load begins to drop off until the load returns to the minimum load around 2-3 am. The utility system peak load is often seen around 5-6 pm.

	<p>Hawaiian Electric</p> <p><i>H47-2 Representative High-Penetration Photo-Voltaic Circuit Study</i></p>
---	---

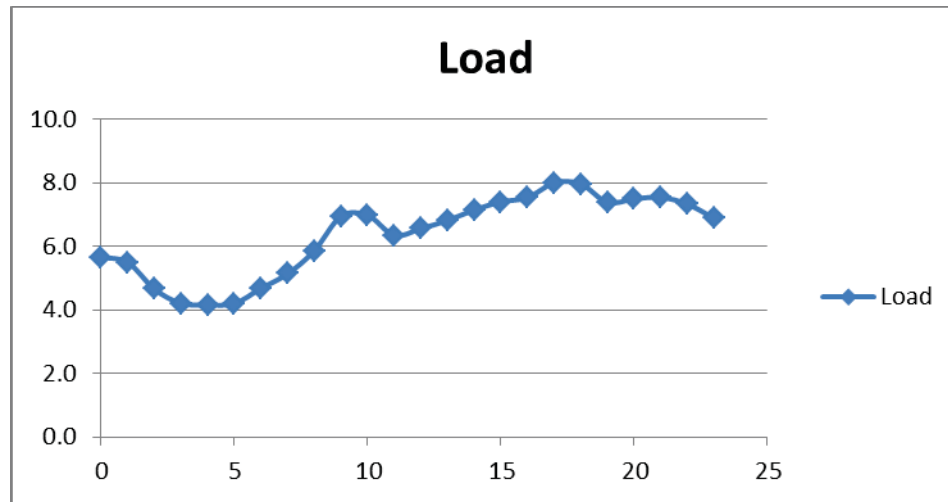

Figure 12 Feeder Load Curve

Solar Curve

The solar generation profile follows the intensity of the sun. In the morning the sun comes up when the solar irradiance is quite low. The peak solar irradiance is typically around noon to 1 pm. After which the solar irradiance drops off until the sun sets in the afternoon. The time of sun rise and sun set Varies depending on latitude and time of year but the general shape is more or less the same throughout the year. Figure 13 Solar Generation shows typical generation profile in this case a large solar array.

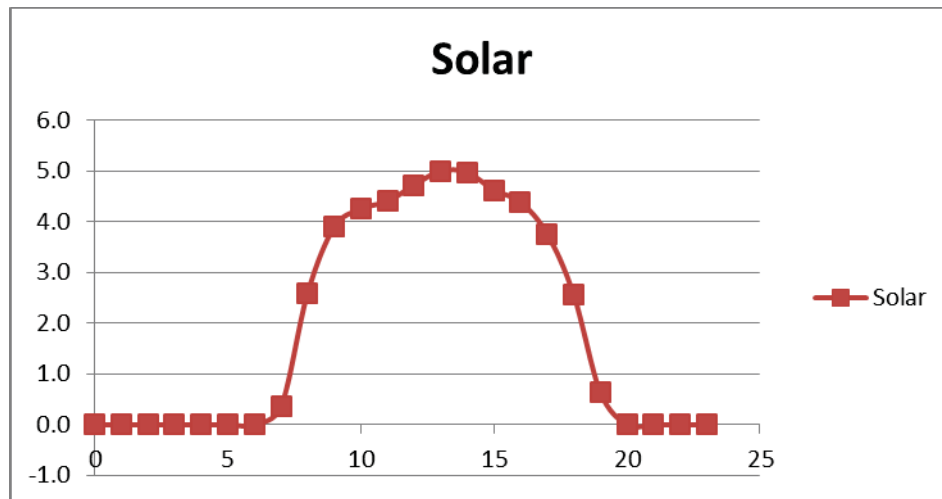

Figure 13 Solar Generation

Load and Solar Profiles

When both curves are plotted on top of each other it becomes easy to see that the solar peak does not happen at the same time as either the feeder day minimum load or at the feeder peak load.

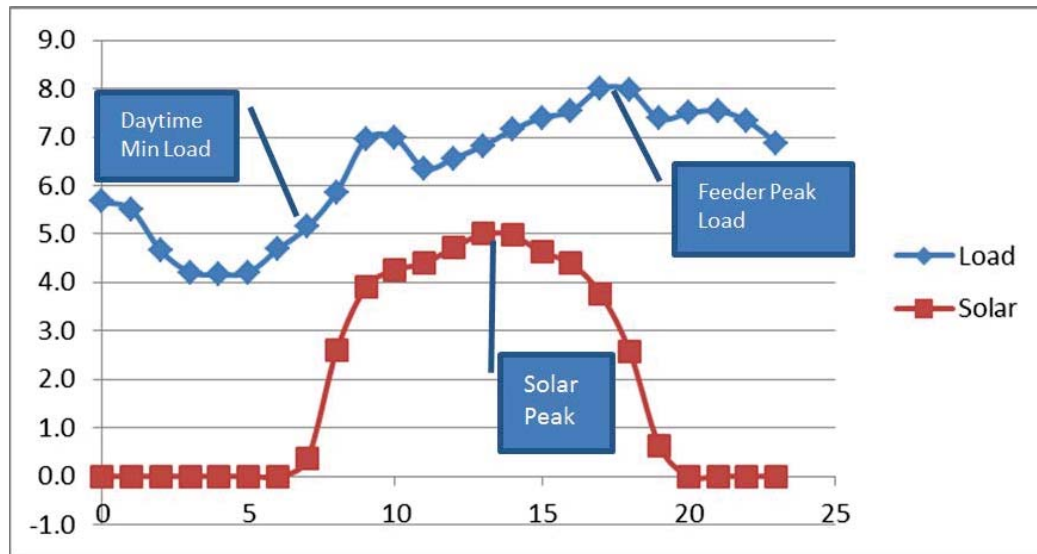

Figure 14 Solar Generation and Feeder Load

Plotting the load curve with the solar generation curve is helpful as can be seen in Figure 14 Solar Generation and Feeder Load. However, to gain understanding of grounding, unintended islanding and other concerns it is necessary to see the relationship between the load and generation as they interact on the feeder.

LPV Plot

This is where the LPV Plot becomes useful. On the LPV Plot the load is load to generation ratio for each hour of the day is plotted against each other in x-y pairs. The x-value of the x-y pair is the load reading for the hour. The y-value is the generation output for the same hour. Each hour is plotted for the daytime hours such that a curve is plotted as shown in Figure 15 LPV Plot.

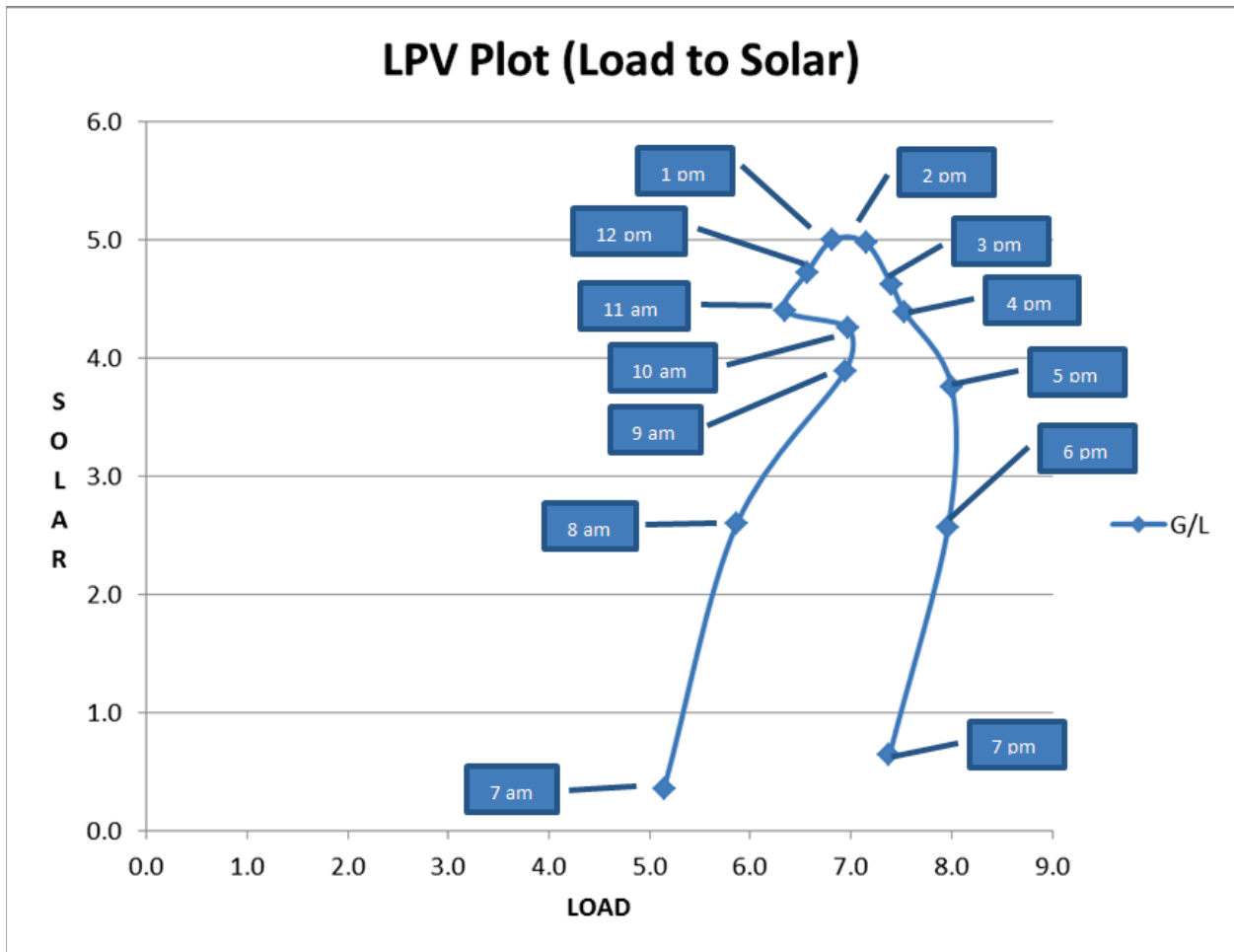

Figure 15 LPV Plot

Unintended Islands (Islanding)

By Plotting the load and generation data in this way makes it simpler to distinguish if there is concern for unintended islanding. There is little opportunity for unintended islanding if the load and generation are not matched. Therefore, by using the LPV Plot it can be easily seen whether there is chance for unintended islanding and for how much of the day and what hours of the day there is a chance for unintended islanding. The chance for unintended islanding occurs at around an even match between load and generation. In other words when there is 1 to 1 match between load and generation there is a chance for unintended islanding. On the LPV Plot a 1:1 line is a line with a slope of 1. To broaden the criteria slightly consider two lines one with a 0.9 slope and another with a 1.1 slope. This gives a range of +/- 10% match between load and generation.

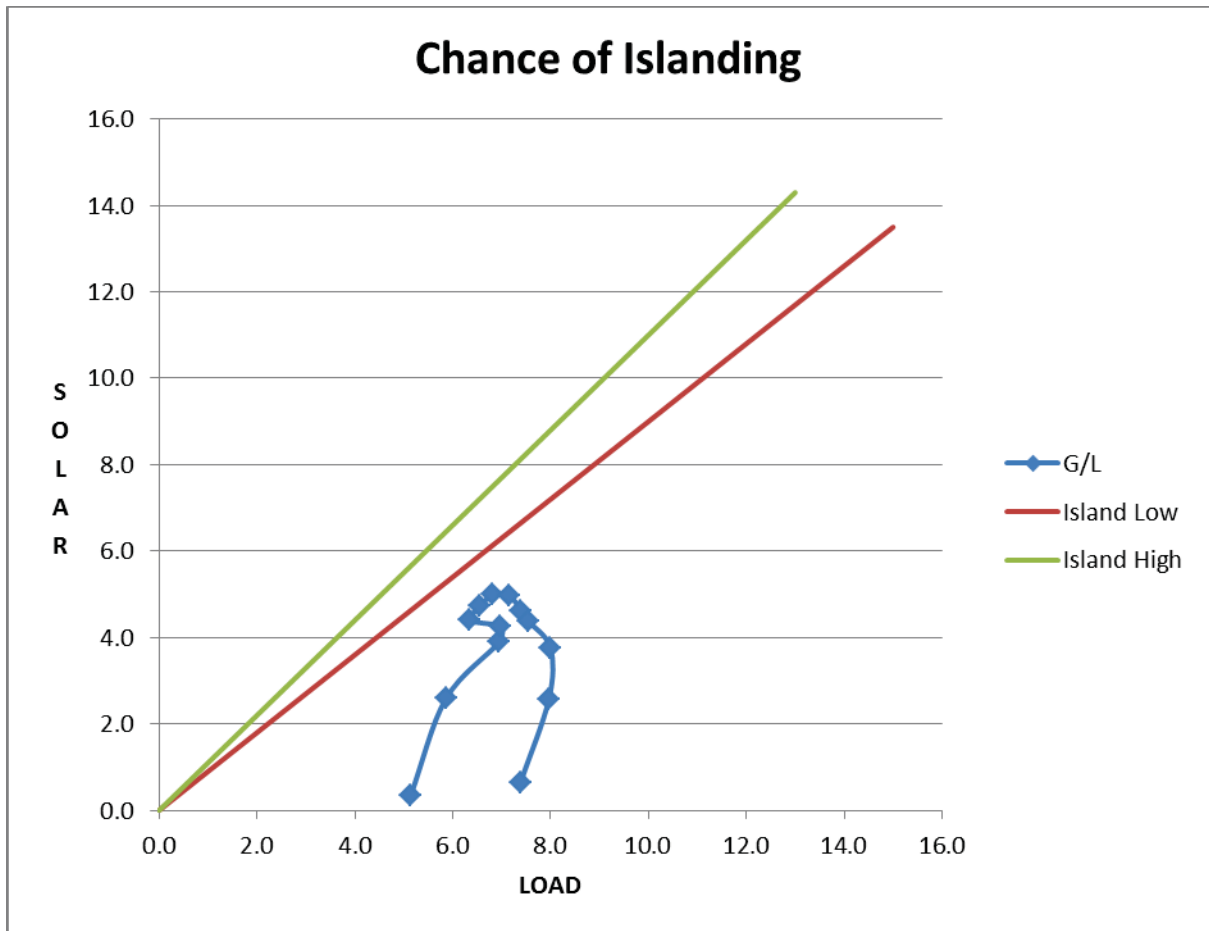



Figure 16 Chance for Unintended Islanding

In Figure 16 Chance for Unintended Islanding it is apparent that there is no chance for unintended islands to develop for this particular loading and generation scenario. If the blue Load-to-Generation curve crosses over the red islanding line then there would be some concern for unintended islanding. Figure 17 Islanding is a Possibility for 2 hours shows a case in which the feeder load and the solar generation are such that islanding becomes a possibility. In this example enough solar generation has been added to the feeder to cause the Load-to-Generation curve to grow vertically which brings the curve into the islanding zone of the plot. The island zone is the area between the red line (Island Low = 0.9 slope) and the green line (Island High = 1.1 slope). In this case with these particular load and generation profiles there is about a 5 hour period in which islanding is a possibility. Figure 18 Islanding is a Possibility for 5 hours shows another case in which the Load-to-Generation curve hovers within the islanding zone for about five hours.

	Hawaiian Electric	<i>H47-2 Representative High-Penetration Photo-Voltaic Circuit Study</i>
---	--------------------------	--

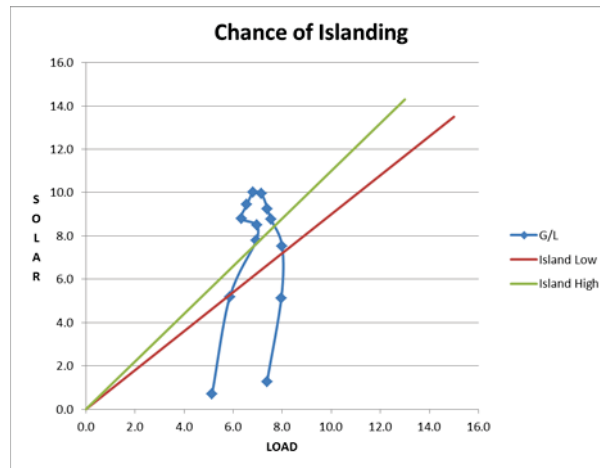

Figure 17 Islanding is a Possibility for 2 hours

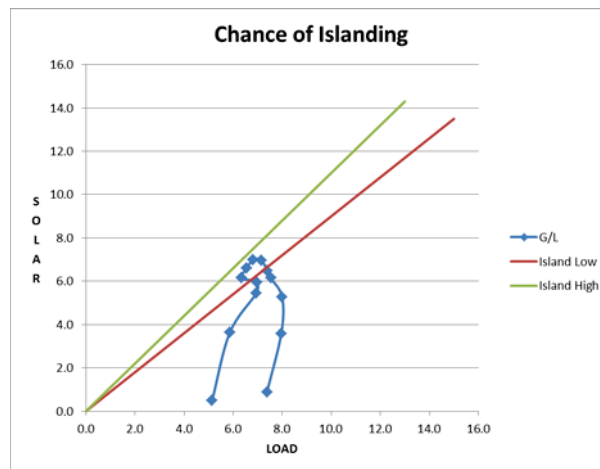

Figure 18 Islanding is a Possibility for 5 hours

Load-Generation Box

It is often the case that the Load profile and/or generation profile is unavailable. In this case by knowing the feeder minimum day-time load, the feeder peak load, and the peak solar generation a box can be drawn that will enclose any conceivable path that the Load-to-generation path may take. Simply draw vertical lines for the minimum day-time load and the peak load. Then draw a horizontal line for the peak solar generation as depicted in Figure 19 Load-Generation Box. The upper left corner of the Load-Generation Box happens to be the MLGR previously discussed. When compared to the islanding zone in Figure 20 Load-Generation Box w/Island Zone MLGR indicates a likelihood of islanding where the upper left corner of the Load-Generation Box (MLGR) crosses over into the islanding zone of the plot. This



demonstrates the conservative nature, albeit not incorrect, of using MLGR to determine the likelihood of islanding.

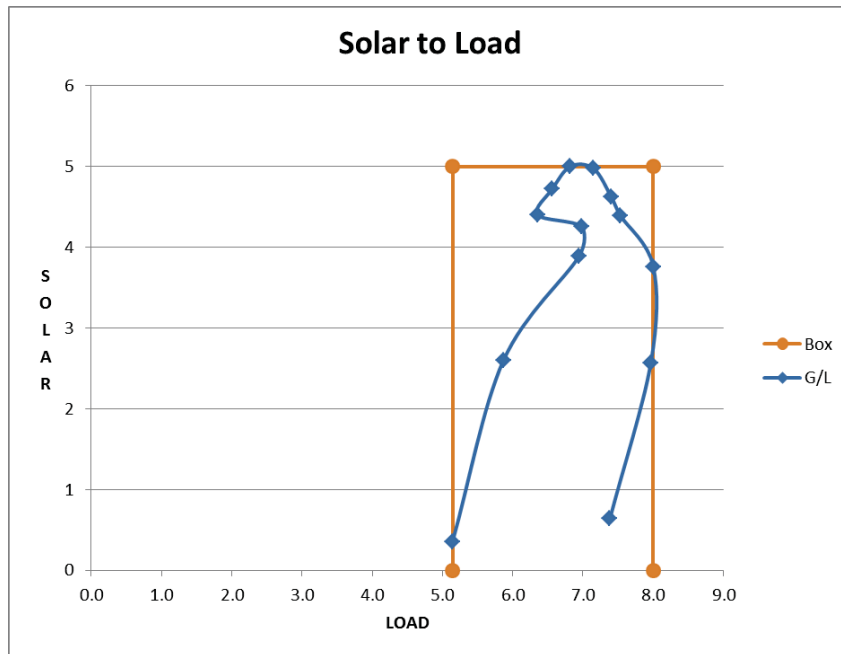

Figure 19 Load-Generation Box

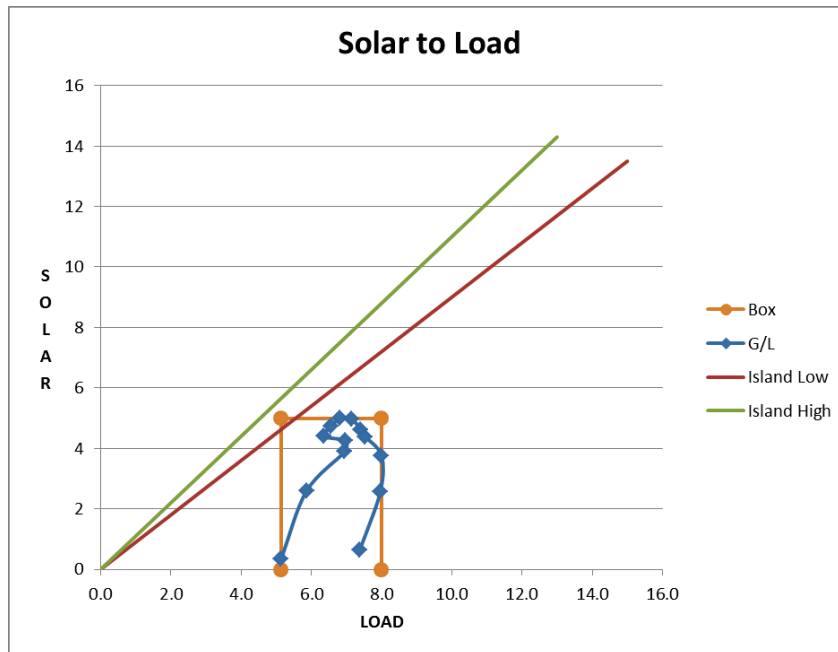



Figure 20 Load-Generation Box w/Island Zone

Ground Fault Overvoltage

Ground fault over voltage occurs when a single line to ground fault leads to an over voltage condition on the un-faulted phases. This overvoltage can be as much as $\sqrt{3}$ times the un-faulted voltage. A guideline for screening for Supression Analysis for Ground Fault Overvoltage is a MLGR of 3. In the LPV Plot this represents a line with a slope of 3.

	Hawaiian Electric	<i>H47-2 Representative High-Penetration Photo-Voltaic Circuit Study</i>
---	--------------------------	--

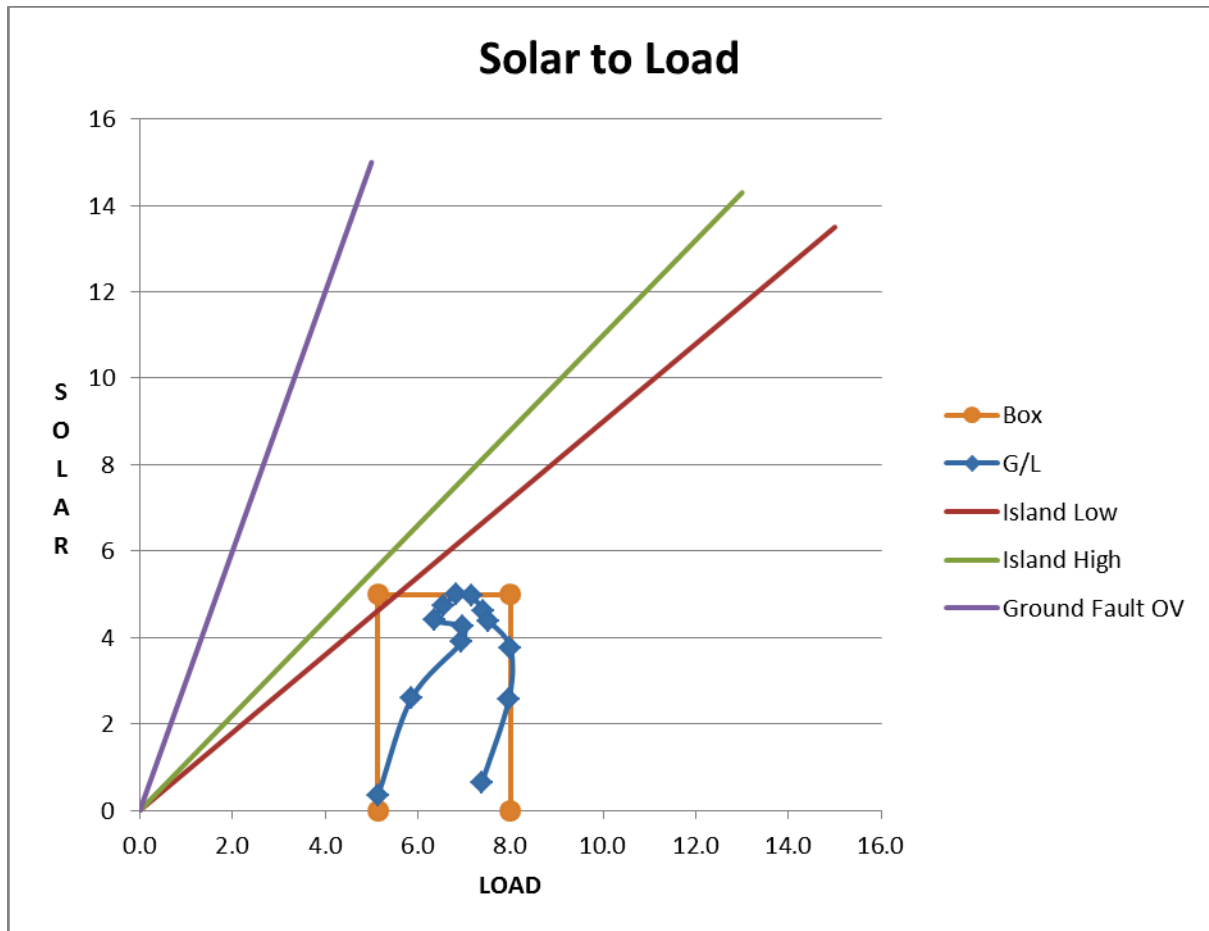



Figure 21 Ground Fault Overvoltage

Figure 21 Ground Fault Overvoltage shows the line with a slope of 3 (purple line) which represents the screening criteria for Ground Fault Overvoltage. If any portion of the LPV Curve or LPV Box is above the purple line then there is a potential for Ground Fault Overvoltage. If then entire LPV Box is below the purple line then there is no expected risk of Ground Fault Overvoltage.

Reverse Overload

A reverse overload occurs when there is sufficient solar generation on the feeder to lead to enough reverse power flow on the feeder such that the wire reaches a thermal overload from current flowing in the reverse direction. In this case the line in the LPV Plot that shows the reverse overload limitation has a slope of 1, but has a y intercept of 8 MVA. The slope intercept of 8 MVA describes a condition where a feeder has 8 MVA of generation with no load. This is for a feeder that has an 8 MVA thermal limit. The slope of 1 carries the 8 MVA limit forward. If a feeder has 10 MVA of generation and 2 MVA of load then

	Hawaiian Electric	<i>H47-2 Representative High-Penetration Photo-Voltaic Circuit Study</i>
---	--------------------------	--

there can be 8 MVA of reverse flow. Therefore, a slope of 1 accounts for the generation consumed by the local load.

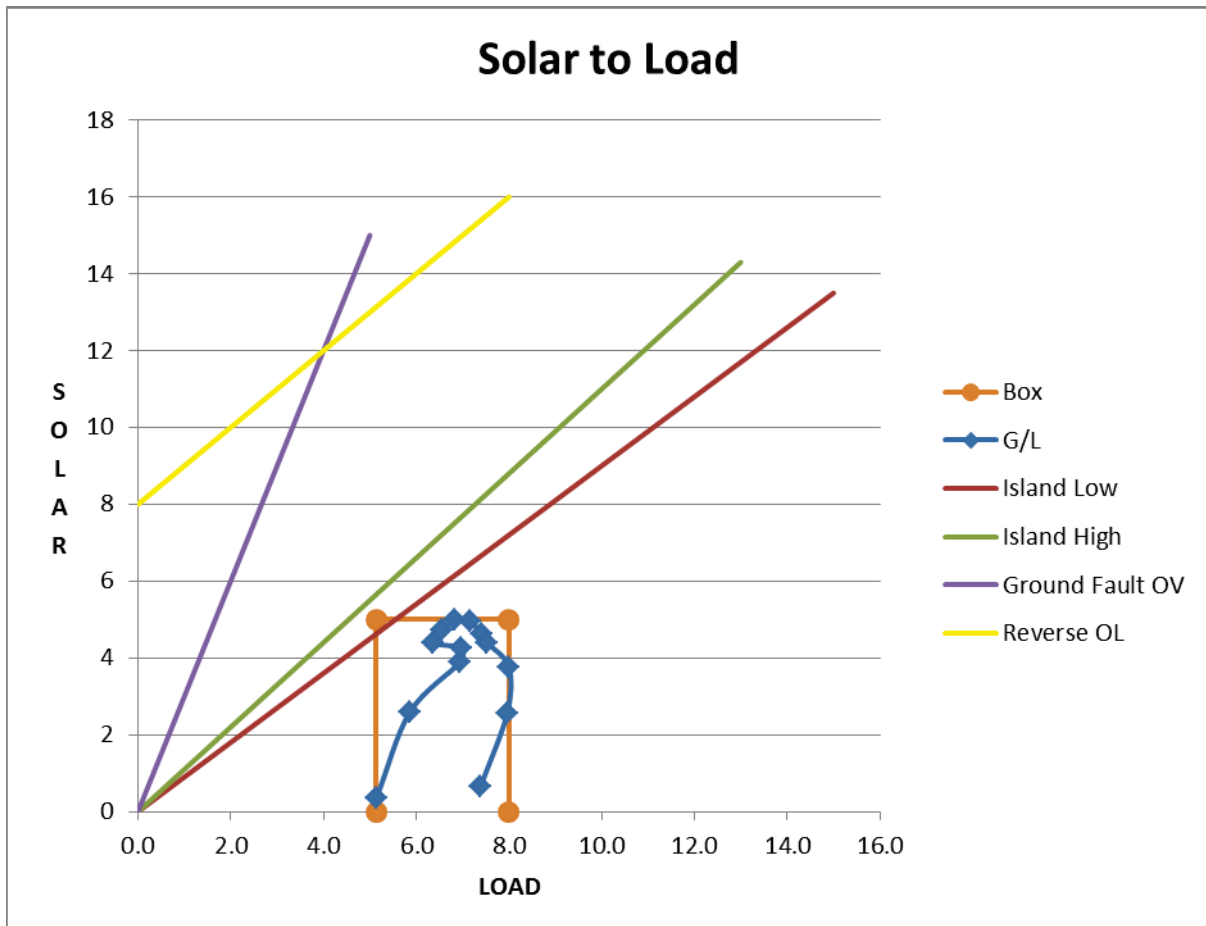

Figure 22 Reverse Overload

Figure 22 Reverse Overload demonstrates the plot of the reverse overload on the LPV Plot in yellow.

Risk of the Occurrence of an Event

Using the LPV Plot risk associated with particular events of concern can be calculated by calculating the area of the Load-Generation box and calculating the area of the box that crosses the line of a particular risk area. Take for example the risk of islanding. Once the Load-Generation box crosses over the islanding line there is some risk that an unintended island could occur. For any particular event, calculate the risk by following these steps:

1. Calculate the area of the Load-Generation Box (Load-Generation Area)
2. Calculate the area of the Load-Generation Box that falls within the zone where the event is a possibility (Event Risk Area)
3. Divide the Event Risk Area by the Load-Generation Area
4. Divide by 100 to convert to percent risk

Example

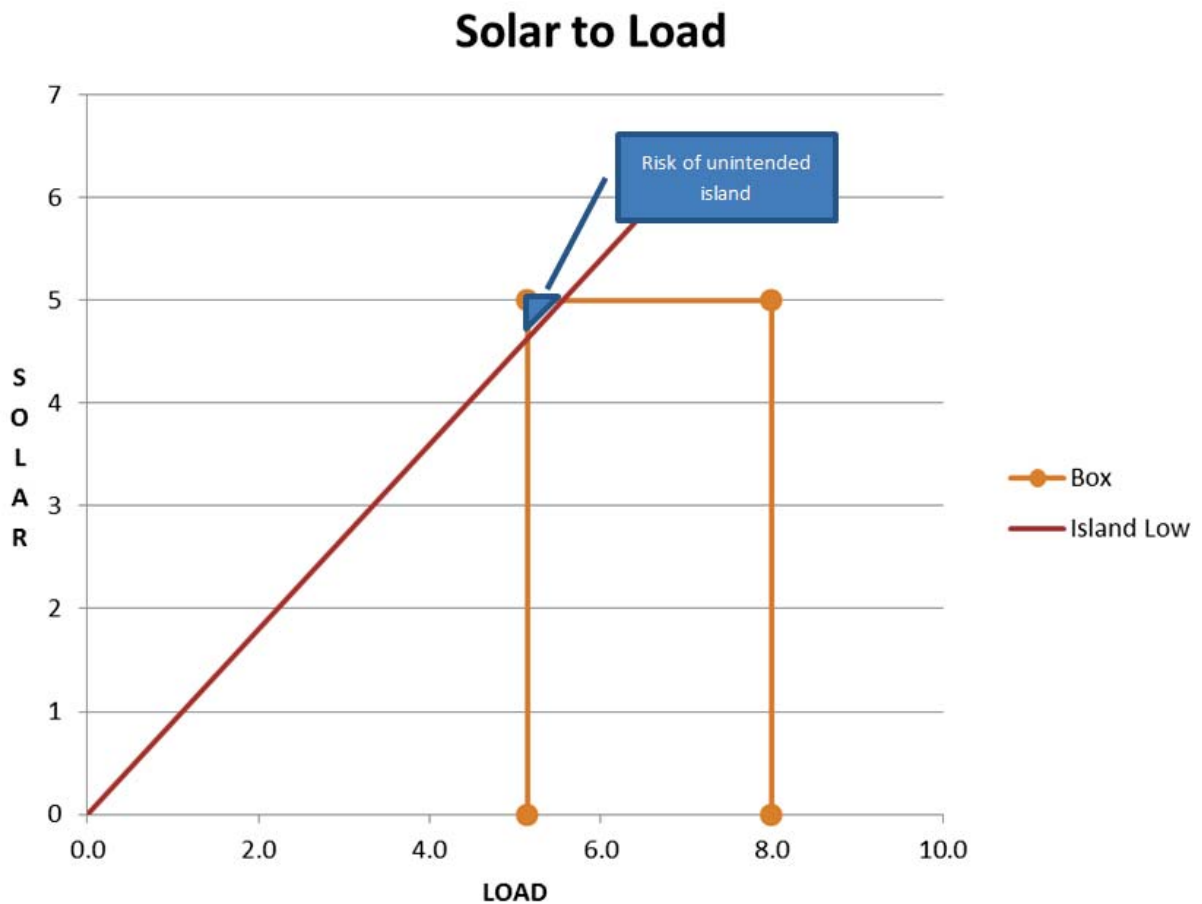
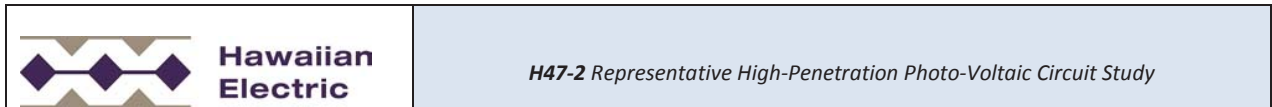

Figure 23 Risk of Islanding

Area of Load-Generation Box

$$8.0 - 5.1 = 2.9 \text{ width of box}$$

$$2.9 * 5 = 14.5 \text{ Area of box}$$



$Y = .9 * 5.1 = 4.59$ height to bottom of triangle

$5 - 4.59 = .41$ height of triangle

$X = y / .9 = 5 / .9 = 5.5555$ x position of right tip of triangle

$5.5555 - 5 = .5555$ width of triangle

$(.5555 * .41) / 2 = 0.1138775$ Area of triangle

$0.1138775 / 14.5 = 0.007853 / 100 = \mathbf{0.8\% \text{ risk of islanding}}$

In the above example a risk of 0.8% of the daytime hours there could be a possibility for conditions to exist such that an unintended island could occur. Depending on the path of the Load-to-Generation curve this risk may or may not have any bearing on reality. Figure 24 Box vs. L-G Path shows how it is possible that the path that the Load-to-Generation may take may never cross into the zone where islanding is a possibility. However, the Load-Generation Box does cross over. It is important to understand that the Load-to-Generation path will always be enclosed by the Load-Generation Box. It is also important to understand that the Load-to-Generation path is not necessarily perfectly consistent from day to day or season to season. However, the Load-Generation Box is more or less fixed for a particular feeder due to the Feeder Daytime Minimum Load and the Feeder Peak load being (or should be) based on an annual load profile and should be the extremes for the feeder. The solar peak should similarly be for the peak expected solar generation on the feeder for the year. Therefore, the risk calculation method presented here will tend to be more conservative than what actually exists on the feeder. If a more accurate calculation is required then use the Load-to-Generation path and evaluate how many hours (or minutes) it crosses over the risk area of interest. Be sure to consider that the path may vary slightly throughout the year. Also bear in mind that the risk calculated is based on daytime hours, in this case 7 am to 7 pm. The daytime hours are when the sun shines.

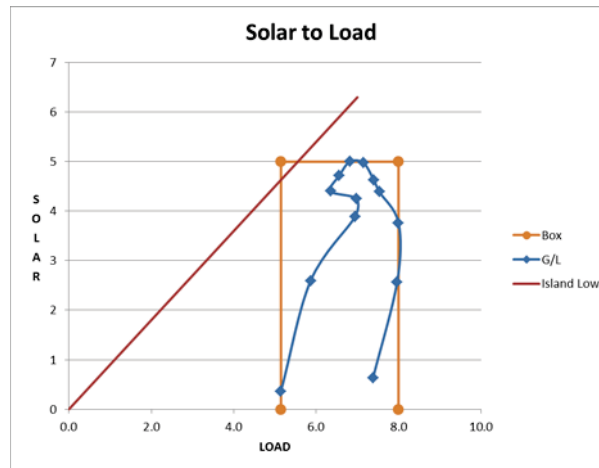
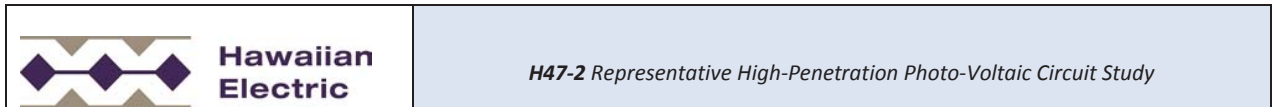



Figure 24 Box vs. L-G Path



Appendix C – LPV Findings

The following tables are the findings from bracketed penetrations of solar for H47-2 at the time of the study as well as generalized findings that can apply across the Hawaiian Electric Company System. The calculator used is: LPV_Plot.xlsx [18].

 Hawaiian Electric	H47-2 Representative High-Penetration Photo-Voltaic Circuit Study
--	--

H47-2

Peak	DML	Solar	% Penetration	Load Limit	Reverse Flow	Island 15%	TOV Load Rejection	TOV Ground Fault	Reverse Over-Load
2.583	1.407	0.14	10%	7	0%	0%	0%	0%	0%
2.583	1.407	0.28	20%	7	0%	0%	0%	0%	0%
2.583	1.407	0.42	30%	7	0%	0%	0%	0%	0%
2.583	1.407	0.56	40%	7	0%	0%	0%	0%	0%
2.583	1.407	0.70	50%	7	0%	0%	0%	0%	0%
2.583	1.407	0.84	60%	7	0%	0%	0%	0%	0%
2.583	1.407	0.98	70%	7	0%	0%	0%	0%	0%
2.583	1.407	1.13	80%	7	0%	0%	0%	0%	0%
2.583	1.407	1.27	90%	7	0%	0%	0%	0%	0%
2.583	1.407	1.41	100%	7	0%	2%	0%	0%	0%
2.583	1.407	1.55	110%	7	1%	4%	0%	0%	0%
2.583	1.407	1.69	120%	7	2%	7%	0%	0%	0%
2.583	1.407	1.83	130%	7	4%	10%	0%	0%	0%
2.583	1.407	1.97	140%	7	7%	13%	0%	0%	0%
2.583	1.407	2.11	150%	7	10%	16%	0%	0%	0%
2.583	1.407	2.25	160%	7	13%	18%	0%	0%	0%
2.583	1.407	2.39	170%	7	17%	20%	1%	0%	0%
2.583	1.407	2.53	180%	7	21%	21%	2%	0%	0%
2.583	1.407	2.67	190%	7	25%	21%	3%	0%	0%
2.583	1.407	2.81	200%	7	29%	21%	5%	0%	0%
2.583	1.407	2.95	210%	7	32%	20%	7%	0%	0%
2.583	1.407	3.10	220%	7	36%	19%	9%	0%	0%
2.583	1.407	3.24	230%	7	38%	18%	11%	0%	0%
2.583	1.407	3.38	240%	7	41%	18%	13%	0%	0%
2.583	1.407	3.52	250%	7	43%	17%	16%	0%	0%
2.583	1.407	3.66	260%	7	45%	16%	19%	0%	0%
2.583	1.407	3.80	270%	7	47%	16%	21%	0%	0%
2.583	1.407	3.94	280%	7	49%	15%	24%	0%	0%
2.583	1.407	4.08	290%	7	51%	15%	27%	0%	0%
2.583	1.407	4.22	300%	7	53%	14%	29%	0%	0%
2.583	1.407	4.36	310%	7	54%	14%	31%	0%	0%
2.583	1.407	4.50	320%	7	56%	13%	34%	0%	0%
2.583	1.407	4.64	330%	7	57%	13%	36%	1%	0%
2.583	1.407	4.78	340%	7	58%	13%	37%	1%	0%
2.583	1.407	4.92	350%	7	59%	12%	39%	1%	0%
2.583	1.407	5.07	360%	7	61%	12%	41%	2%	0%
2.583	1.407	5.21	370%	7	62%	11%	43%	3%	0%
2.583	1.407	5.35	380%	7	63%	11%	44%	3%	0%
2.583	1.407	5.49	390%	7	64%	11%	45%	4%	0%
2.583	1.407	5.63	400%	7	65%	11%	47%	5%	0%
2.583	1.407	5.77	410%	7	65%	10%	48%	6%	0%
2.583	1.407	5.91	420%	7	66%	10%	49%	7%	0%
2.583	1.407	6.05	430%	7	67%	10%	51%	8%	0%
2.583	1.407	6.19	440%	7	68%	10%	52%	9%	0%
2.583	1.407	6.33	450%	7	68%	9%	53%	10%	0%
2.583	1.407	6.47	460%	7	69%	9%	54%	11%	0%
2.583	1.407	6.61	470%	7	70%	9%	55%	12%	0%
2.583	1.407	6.75	480%	7	70%	9%	56%	13%	0%
2.583	1.407	6.89	490%	7	71%	9%	57%	15%	0%
2.583	1.407	7.04	500%	7	72%	9%	57%	16%	0%
2.583	1.407	7.18	510%	7	72%	8%	58%	17%	0%
2.583	1.407	7.32	520%	7	73%	8%	59%	19%	0%
2.583	1.407	7.46	530%	7	73%	8%	60%	20%	0%
2.583	1.407	7.60	540%	7	74%	8%	61%	21%	0%
2.583	1.407	7.74	550%	7	74%	8%	61%	23%	0%
2.583	1.407	7.88	560%	7	75%	8%	62%	24%	0%
2.583	1.407	8.02	570%	7	75%	7%	63%	25%	0%
2.583	1.407	8.16	580%	7	75%	7%	63%	25%	0%
2.583	1.407	8.30	590%	7	76%	7%	63%	27%	0%
2.583	1.407	8.44	600%	7	76%	7%	64%	28%	0%
2.583	1.407	8.58	610%	7	76%	7%	65%	29%	0%
2.583	1.407	8.72	620%	7	77%	7%	65%	30%	0%
2.583	1.407	8.86	630%	7	77%	7%	66%	31%	0%
2.583	1.407	8.86	630%	7	77%	7%	66%	32%	1%

	Hawaiian Electric	<i>H47-2 Representative High-Penetration Photo-Voltaic Circuit Study</i>
---	--------------------------	--

5 MVA Pk, 2 MVA DML, 40% DLR

Peak	DML	Solar	% Penetration	Load Limit	Reverse Flow	Island 15%	TOV Load Rejection	TOV Ground Fault	Reverse Over-Load
5	2	0.20	10%	7	0%	0%	0%	0%	0%
5	2	0.40	20%	7	0%	0%	0%	0%	0%
5	2	0.60	30%	7	0%	0%	0%	0%	0%
5	2	0.80	40%	7	0%	0%	0%	0%	0%
5	2	1.00	50%	7	0%	0%	0%	0%	0%
5	2	1.20	60%	7	0%	0%	0%	0%	0%
5	2	1.40	70%	7	0%	0%	0%	0%	0%
5	2	1.60	80%	7	0%	0%	0%	0%	0%
5	2	1.80	90%	7	0%	0%	0%	0%	0%
5	2	2.00	100%	7	0%	1%	0%	0%	0%
5	2	2.20	110%	7	0%	2%	0%	0%	0%
5	2	2.40	120%	7	1%	4%	0%	0%	0%
5	2	2.60	130%	7	2%	6%	0%	0%	0%
5	2	2.80	140%	7	4%	7%	0%	0%	0%
5	2	3.00	150%	7	6%	9%	0%	0%	0%
5	2	3.20	160%	7	8%	10%	0%	0%	0%
5	2	3.40	170%	7	10%	12%	1%	0%	0%
5	2	3.60	180%	7	12%	13%	1%	0%	0%
5	2	3.80	190%	7	14%	14%	2%	0%	0%
5	2	4.00	200%	7	17%	15%	3%	0%	0%
5	2	4.20	210%	7	19%	17%	4%	0%	0%
5	2	4.40	220%	7	22%	18%	5%	0%	0%
5	2	4.60	230%	7	24%	19%	6%	0%	0%
5	2	4.80	240%	7	27%	19%	8%	0%	0%
5	2	5.00	250%	7	30%	19%	9%	0%	0%
5	2	5.20	260%	7	33%	19%	10%	0%	0%
5	2	5.40	270%	7	35%	19%	12%	0%	0%
5	2	5.60	280%	7	38%	19%	13%	0%	0%
5	2	5.80	290%	7	40%	18%	15%	0%	0%
5	2	6.00	300%	7	42%	17%	17%	0%	0%
5	2	6.20	310%	7	44%	17%	18%	0%	0%
5	2	6.40	320%	7	45%	16%	20%	0%	0%
5	2	6.60	330%	7	47%	16%	22%	0%	0%
5	2	6.80	340%	7	49%	15%	24%	1%	0%
5	2	7.00	350%	7	50%	15%	25%	1%	0%
5	2	7.20	360%	7	51%	15%	27%	1%	0%
5	2	7.40	370%	7	53%	14%	29%	1%	0%
5	2	7.60	380%	7	54%	14%	31%	2%	0%
5	2	7.80	390%	7	55%	13%	33%	2%	0%
5	2	8.00	400%	7	56%	13%	34%	3%	0%
5	2	8.20	410%	7	57%	13%	36%	3%	0%
5	2	8.40	420%	7	58%	13%	38%	4%	0%
5	2	8.60	430%	7	59%	12%	39%	4%	0%
5	2	8.80	440%	7	60%	12%	40%	5%	0%
5	2	9.00	450%	7	61%	12%	42%	6%	0%
5	2	9.20	460%	7	62%	11%	43%	6%	0%
5	2	9.40	470%	7	63%	11%	44%	7%	0%
5	2	9.60	480%	7	64%	11%	45%	8%	1%

	Filename: H47-2_Final.Docx Modified: 2/25/14 Page: 76 of 113
---	---

 Hawaiian Electric	<i>H47-2 Representative High-Penetration Photo-Voltaic Circuit Study</i>
--	--

7 MVA Pk, 2.8 MVA DML, 40% DLR

Peak	DML	Solar	% Penetration	Load Limit	Reverse Flow	Island 15%	TOV Load Rejection	TOV Ground Fault	Reverse Over-Load
7	2.8	0.28	10%	7	0%	0%	0%	0%	0%
7	2.8	0.56	20%	7	0%	0%	0%	0%	0%
7	2.8	0.84	30%	7	0%	0%	0%	0%	0%
7	2.8	1.12	40%	7	0%	0%	0%	0%	0%
7	2.8	1.40	50%	7	0%	0%	0%	0%	0%
7	2.8	1.68	60%	7	0%	0%	0%	0%	0%
7	2.8	1.96	70%	7	0%	0%	0%	0%	0%
7	2.8	2.24	80%	7	0%	0%	0%	0%	0%
7	2.8	2.52	90%	7	0%	0%	0%	0%	0%
7	2.8	2.80	100%	7	0%	1%	0%	0%	0%
7	2.8	3.08	110%	7	0%	2%	0%	0%	0%
7	2.8	3.36	120%	7	1%	4%	0%	0%	0%
7	2.8	3.64	130%	7	2%	6%	0%	0%	0%
7	2.8	3.92	140%	7	4%	7%	0%	0%	0%
7	2.8	4.20	150%	7	6%	9%	0%	0%	0%
7	2.8	4.48	160%	7	8%	10%	0%	0%	0%
7	2.8	4.76	170%	7	10%	12%	1%	0%	0%
7	2.8	5.04	180%	7	12%	13%	1%	0%	0%
7	2.8	5.32	190%	7	14%	14%	2%	0%	0%
7	2.8	5.60	200%	7	17%	15%	3%	0%	0%
7	2.8	5.88	210%	7	19%	17%	4%	0%	0%
7	2.8	6.16	220%	7	22%	18%	5%	0%	0%
7	2.8	6.44	230%	7	24%	19%	6%	0%	0%
7	2.8	6.72	240%	7	27%	19%	8%	0%	0%
7	2.8	7.00	250%	7	30%	19%	9%	0%	0%
7	2.8	7.28	260%	7	33%	19%	10%	0%	0%
7	2.8	7.56	270%	7	35%	19%	12%	0%	0%
7	2.8	7.84	280%	7	38%	19%	13%	0%	0%
7	2.8	8.12	290%	7	40%	18%	15%	0%	0%
7	2.8	8.40	300%	7	42%	17%	17%	0%	0%
7	2.8	8.68	310%	7	44%	17%	18%	0%	0%
7	2.8	8.96	320%	7	45%	16%	20%	0%	0%
7	2.8	9.24	330%	7	47%	16%	22%	0%	0%
7	2.8	9.52	340%	7	49%	15%	24%	1%	0%
7	2.8	9.80	350%	7	50%	15%	25%	1%	0%
7	2.8	10.08	360%	7	51%	15%	27%	1%	0%
7	2.8	10.36	370%	7	53%	14%	29%	1%	0%
7	2.8	10.64	380%	7	54%	14%	31%	2%	1%

 Hawaiian Electric	<i>H47-2 Representative High-Penetration Photo-Voltaic Circuit Study</i>
--	--

7 MVA Pk, 2.8 MVA DML, 50% DLR

Peak	DML	Solar	% Penetration	Load Limit	Reverse Flow	Island 15%	Island 10%	TOV Load Rejection	TOV Ground Fault	Reverse Over-Load
7	3.5	0.35	10%	7	0%	0%	0%	0%	0%	0%
7	3.5	0.70	20%	7	0%	0%	0%	0%	0%	0%
7	3.5	1.05	30%	7	0%	0%	0%	0%	0%	0%
7	3.5	1.40	40%	7	0%	0%	0%	0%	0%	0%
7	3.5	1.75	50%	7	0%	0%	0%	0%	0%	0%
7	3.5	2.10	60%	7	0%	0%	0%	0%	0%	0%
7	3.5	2.45	70%	7	0%	0%	0%	0%	0%	0%
7	3.5	2.80	80%	7	0%	0%	0%	0%	0%	0%
7	3.5	3.15	90%	7	0%	0%	0%	0%	0%	0%
7	3.5	3.50	100%	7	0%	1%	1%	0%	0%	0%
7	3.5	3.85	110%	7	0%	3%	2%	0%	0%	0%
7	3.5	4.20	120%	7	2%	6%	4%	0%	0%	0%
7	3.5	4.55	130%	7	3%	8%	5%	0%	0%	0%
7	3.5	5.25	150%	7	8%	13%	8%	0%	0%	0%
7	3.5	5.60	160%	7	11%	15%	10%	0%	0%	0%
7	3.5	5.95	170%	7	14%	17%	11%	1%	0%	0%
7	3.5	6.30	180%	7	18%	19%	13%	2%	0%	0%
7	3.5	6.65	190%	7	21%	20%	14%	3%	0%	0%
7	3.5	7.00	200%	7	25%	21%	14%	4%	0%	0%
7	3.5	7.35	210%	7	29%	21%	14%	6%	0%	0%
7	3.5	7.70	220%	7	32%	20%	14%	7%	0%	0%
7	3.5	8.05	230%	7	35%	20%	13%	9%	0%	0%
7	3.5	8.40	240%	7	38%	19%	13%	11%	0%	0%
7	3.5	8.75	250%	7	40%	18%	12%	13%	0%	0%
7	3.5	9.10	260%	7	42%	17%	12%	16%	0%	0%
7	3.5	9.45	270%	7	44%	17%	11%	18%	0%	0%
7	3.5	9.80	280%	7	46%	16%	11%	20%	0%	0%
7	3.5	10.50	300%	7	50%	15%	10%	25%	0%	0%
7	3.5	10.85	310%	7	52%	15%	10%	27%	0%	0%
7	3.5	11.20	320%	7	53%	14%	9%	30%	0%	1%
7	3.5	11.55	330%	7	55%	14%	9%	32%	0%	1%
7	3.5	11.90	340%	7	56%	13%	9%	34%	1%	2%

 Hawaiian Electric	<i>H47-2 Representative High-Penetration Photo-Voltaic Circuit Study</i>
--	--

7 MVA Pk, 2.8 MVA DML, 60% DLR

Peak	DML	Solar	% Penetration	Load Limit	Reverse Flow	Island 15%	Island 10%	TOV Load Rejection	TOV Ground Fault	Reverse Over-Load
7	4.2	0.42	10%	7	0%	0%	0%	0%	0%	0%
7	4.2	0.84	20%	7	0%	0%	0%	0%	0%	0%
7	4.2	1.26	30%	7	0%	0%	0%	0%	0%	0%
7	4.2	1.68	40%	7	0%	0%	0%	0%	0%	0%
7	4.2	2.10	50%	7	0%	0%	0%	0%	0%	0%
7	4.2	2.52	60%	7	0%	0%	0%	0%	0%	0%
7	4.2	2.94	70%	7	0%	0%	0%	0%	0%	0%
7	4.2	3.36	80%	7	0%	0%	0%	0%	0%	0%
7	4.2	3.78	90%	7	0%	0%	0%	0%	0%	0%
7	4.2	4.20	100%	7	0%	2%	1%	0%	0%	0%
7	4.2	4.62	110%	7	1%	5%	3%	0%	0%	0%
7	4.2	5.04	120%	7	3%	9%	6%	0%	0%	0%
7	4.2	5.46	130%	7	5%	13%	8%	0%	0%	0%
7	4.2	5.88	140%	7	9%	16%	10%	0%	0%	0%
7	4.2	6.30	150%	7	13%	19%	13%	0%	0%	0%
7	4.2	6.72	160%	7	17%	21%	14%	0%	0%	0%
7	4.2	7.14	170%	7	22%	22%	15%	1%	0%	0%
7	4.2	7.56	180%	7	26%	22%	15%	3%	0%	0%
7	4.2	7.98	190%	7	30%	21%	14%	4%	0%	0%
7	4.2	8.40	200%	7	33%	20%	13%	6%	0%	0%
7	4.2	8.82	210%	7	37%	19%	13%	9%	0%	0%
7	4.2	9.24	220%	7	39%	18%	12%	11%	0%	0%
7	4.2	9.66	230%	7	42%	17%	12%	14%	0%	0%
7	4.2	10.08	240%	7	44%	17%	11%	17%	0%	0%
7	4.2	10.50	250%	7	47%	16%	11%	20%	0%	0%
7	4.2	10.92	260%	7	49%	15%	10%	23%	0%	0%
7	4.2	11.34	270%	7	51%	15%	10%	26%	0%	0%
7	4.2	11.76	280%	7	52%	14%	10%	29%	0%	0%
7	4.2	12.18	290%	7	54%	14%	9%	31%	0%	1%
7	4.2	12.60	300%	7	56%	13%	9%	33%	0%	3%
7	4.2	13.02	310%	7	57%	13%	9%	35%	0%	5%
7	4.2	13.44	320%	7	58%	13%	8%	38%	0%	7%
7	4.2	13.86	330%	7	60%	12%	8%	39%	1%	9%

 <i>Innovative Thinking. Engineered Solutions.</i>	Filename: H47-2_Final.Docx Modified: 2/25/14 Page: 79 of 113
--	---

Appendix D - Load-Flow Results

Stage 2: NEMs study Voltage

H47-2 Day Minimum Load Case

Body Text...

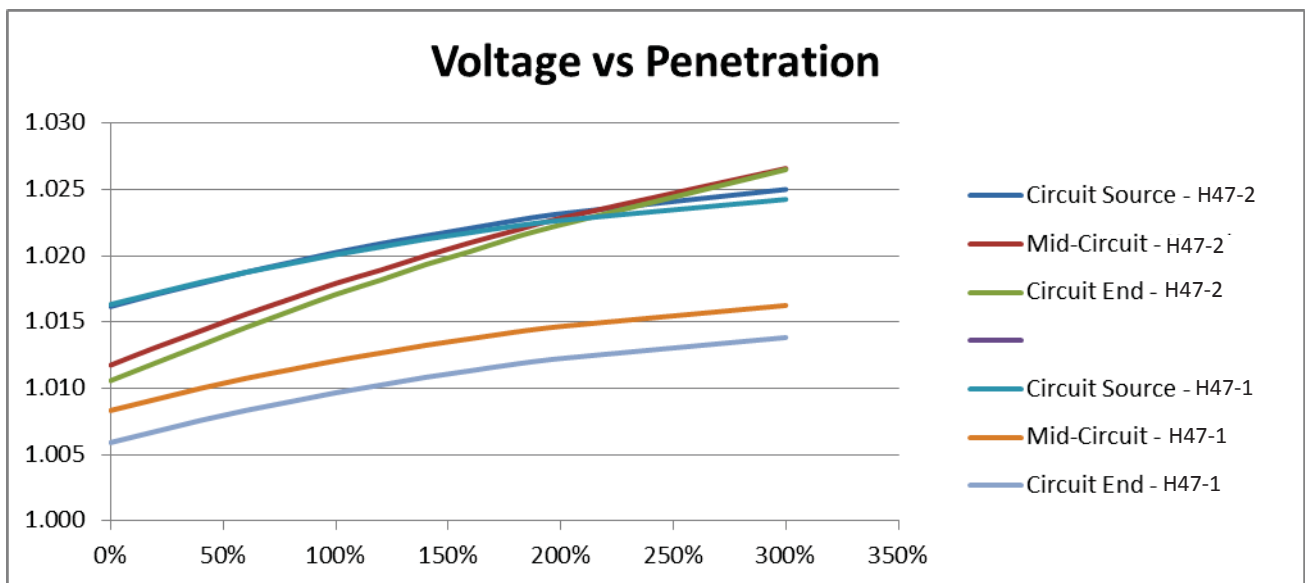

Figure 25 Light Load Voltage VS Penetration - FITS OFF

	Voltage Out - Light Load with a 450 CAP added (% NEM Penetraion pf @ -0.99)											
	0%	20%	40%	60%	80%	100%	120%	140%	160%	180%	200%	300%
Circuit Source - H47-2	1.016	1.017	1.018	1.019	1.020	1.020	1.021	1.022	1.022	1.023	1.023	1.025
Mid-Circuit - H47-2	1.012	1.013	1.014	1.016	1.017	1.018	1.019	1.020	1.021	1.022	1.023	1.027
Circuit End - H47-2	1.011	1.012	1.013	1.015	1.016	1.017	1.018	1.019	1.020	1.021	1.022	1.027
Circuit Source - H47-1	1.016	1.017	1.018	1.019	1.019	1.020	1.021	1.021	1.022	1.022	1.023	1.024
Mid-Circuit - H47-1	1.008	1.009	1.010	1.011	1.011	1.012	1.013	1.013	1.014	1.014	1.015	1.016
Circuit End - H47-1	1.006	1.007	1.008	1.008	1.009	1.010	1.010	1.011	1.011	1.012	1.012	1.014

Table 10 Light Load PU Voltage - FITS OFF



H47-2 Peak Load Case

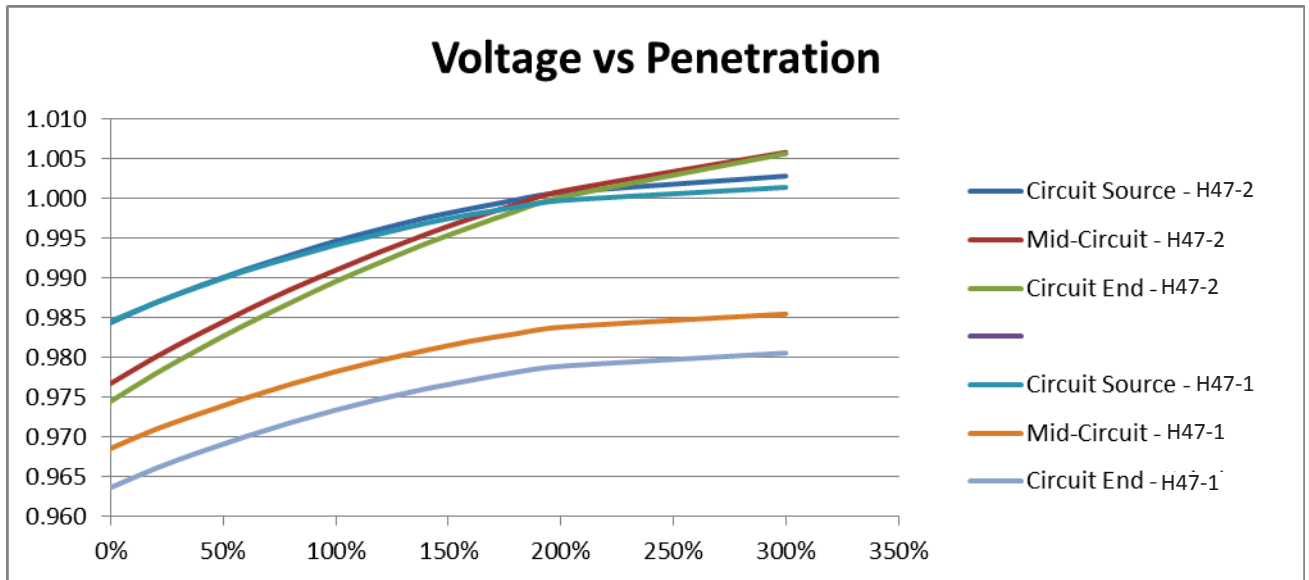



Figure 26 Peak Load Voltage VS Penetration - FITS OFF

	Voltage Out - Peak Load with a 450 CAP added (% NEM Penetraion pf @ -0.99)											
	0%	20%	40%	60%	80%	100%	120%	140%	160%	180%	200%	300%
Circuit Source - H47-2	0.984	0.987	0.989	0.991	0.993	0.995	0.996	0.998	0.999	1.000	1.001	1.003
Mid-Circuit - H47-2	0.977	0.980	0.983	0.986	0.989	0.991	0.993	0.996	0.998	0.999	1.001	1.006
Circuit End - H47-2	0.975	0.978	0.981	0.984	0.987	0.990	0.992	0.994	0.996	0.998	1.000	1.006
Circuit Source - H47-1	0.985	0.987	0.989	0.991	0.993	0.994	0.996	0.997	0.998	0.999	1.000	1.001
Mid-Circuit - H47-1	0.969	0.971	0.973	0.975	0.977	0.978	0.980	0.981	0.982	0.983	0.984	0.986
Circuit End - H47-1	0.964	0.966	0.968	0.970	0.972	0.973	0.975	0.976	0.977	0.978	0.979	0.981

Table 11 Peak Load PU Voltage - FITS OFF

 Hawaiian Electric	<i>H47-2 Representative High-Penetration Photo-Voltaic Circuit Study</i>
--	--

H47-2 High Load Case

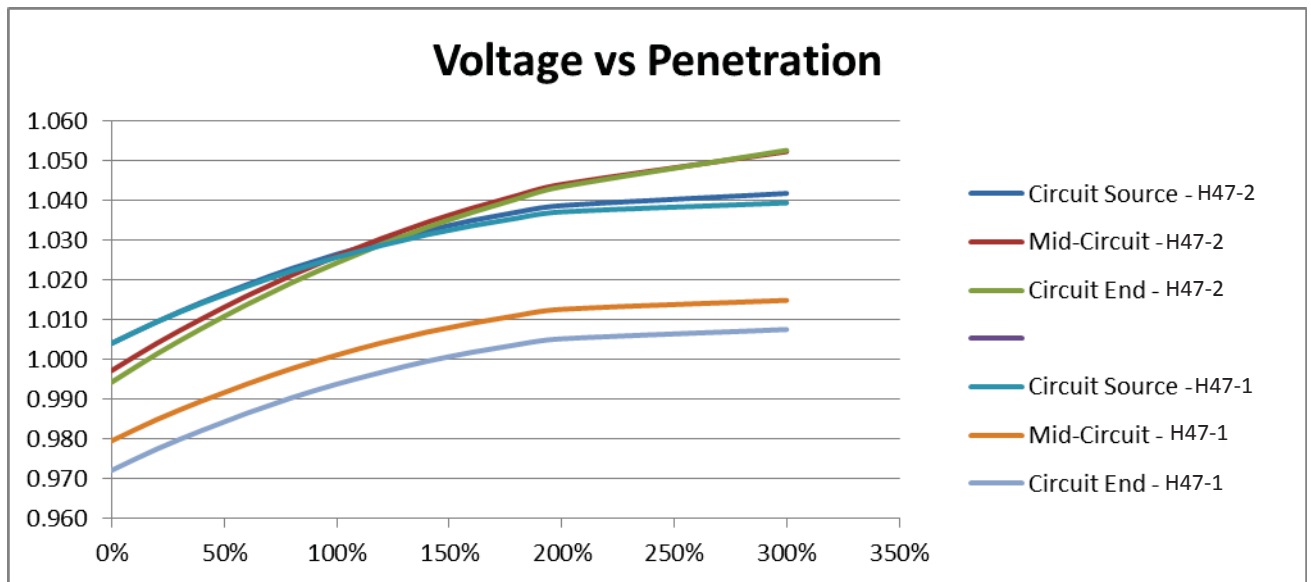

Figure 27 High Load Voltage VS Penetration - FITS OFF

	Voltage Out - High Load with a 2*450 CAP added + LTC@9 + (% NEM Penetraion pf = -0.99)											
	0%	20%	40%	60%	80%	100%	120%	140%	160%	180%	200%	300%
Circuit Source - H47-2	1.004	1.010	1.014	1.019	1.023	1.027	1.030	1.033	1.035	1.037	1.039	1.042
Mid-Circuit - H47-2	0.997	1.004	1.010	1.016	1.021	1.026	1.031	1.035	1.038	1.041	1.044	1.052
Circuit End - H47-2	0.994	1.001	1.008	1.014	1.019	1.024	1.029	1.033	1.037	1.040	1.044	1.053
Circuit Source - H47-1	1.004	1.010	1.014	1.018	1.022	1.026	1.029	1.031	1.034	1.036	1.037	1.039
Mid-Circuit - H47-1	0.980	0.985	0.990	0.994	0.998	1.001	1.004	1.007	1.009	1.011	1.013	1.015
Circuit End - H47-1	0.972	0.978	0.982	0.987	0.990	0.994	0.997	1.000	1.002	1.004	1.005	1.008

Table 12 High Load PU Voltage - FITS OFF

Stage 2: NEMs study kW

H47-2 Day Minimum Load Case



Hawaiian Electric

H47-2 Representative High-Penetration Photo-Voltaic Circuit Study

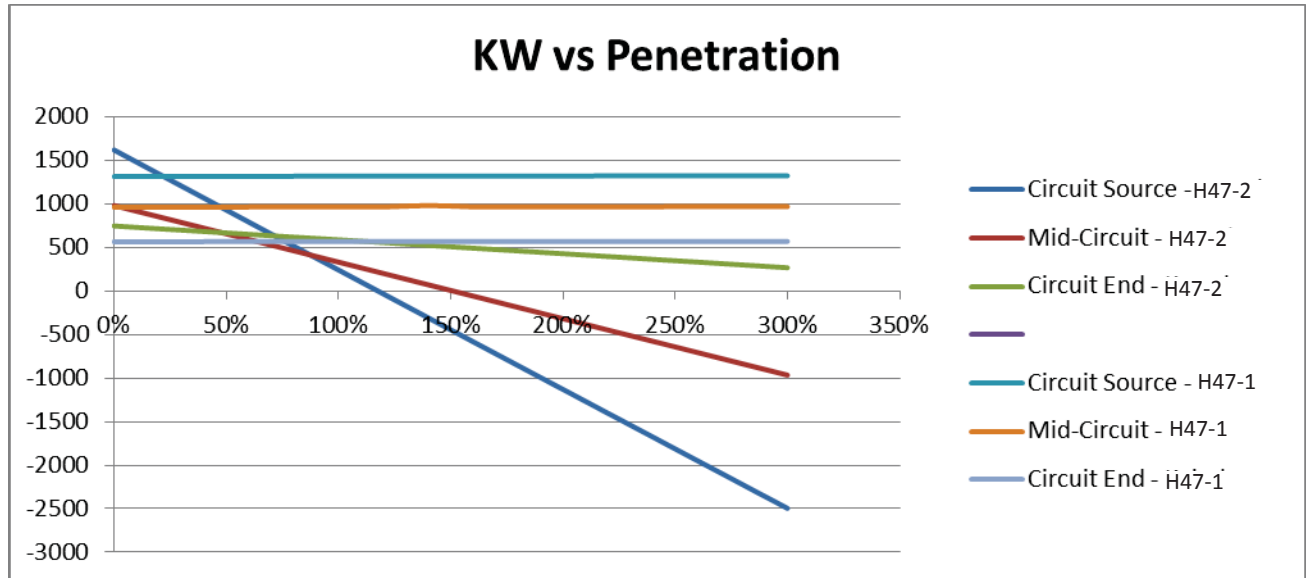

Figure 28 Light Load kW VS Penetration - FITS OFF

	KW Into - Light Load with a 450 CAP added (% NEM Penetration pf @ -0.99)											
	0%	20%	40%	60%	80%	100%	120%	140%	160%	180%	200%	300%
Circuit Source - H47-2	1623	1347	1071	795	519	244	-31	-306	-581	-855	-1129	-2496
Mid-Circuit - H47-2	985	855	725	595	464	334	204	74	-56	-186	-316	-965
Circuit End - H47-2	750	718	686	654	622	591	559	527	495	463	431	270
Circuit Source - H47-1	1317	1318	1319	1320	1321	1321	1322	1323	1323	1324	1324	1326
Mid-Circuit - H47-1	965	965	966	967	967	968	968	985	969	970	970	971
Circuit End - H47-1	568	568	569	569	570	570	570	571	571	571	571	572

Table 13 Light Load kW - FITS OFF



Filename: H47-2_Final.Docx

Modified: 2/25/14 Page: 83 of 113



H47-2 Peak Load Case

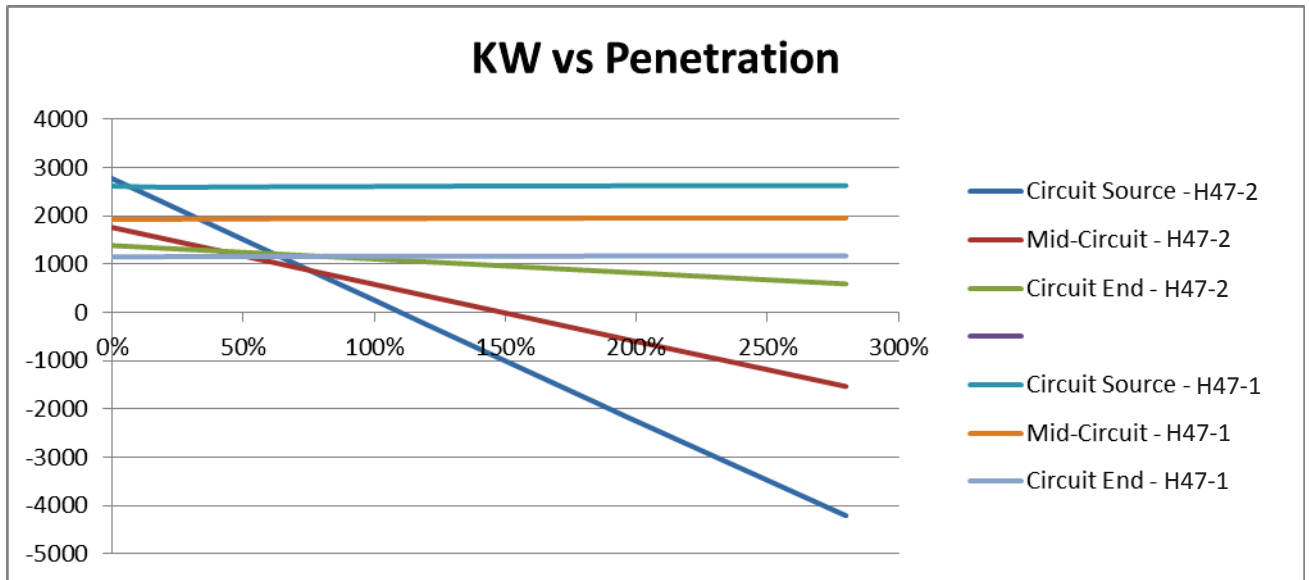

Figure 29 Peak Load kW VS Penetration - FITS OFF

	KW Into - Peak Load with a 450 CAP added (% NEM Penetration pf @ -0.99)											
	0%	20%	40%	60%	80%	100%	120%	140%	160%	180%	200%	280%
Circuit Source - H47-2	2770	2265	1760	1256	753	254	-253	-754	-1253	-1752	-2251	-4208
Mid-Circuit - H47-2	1758	1523	1287	1051	815	580	341	105	-131	-367	-603	-1534
Circuit End - H47-2	1383	1327	1272	1216	1160	1104	1046	990	933	875	818	589
Circuit Source - H47-1	2613	2589	2594	2599	2603	2606	2610	2613	2615	2617	2619	2623
Mid-Circuit - H47-1	1924	1928	1932	1935	1938	1941	1943	1946	1947	1949	1951	1953
Circuit End - H47-1	1151	1153	1155	1157	1159	1161	1162	1164	1165	1166	1167	1168

Table 14 Peak Load kW - FITS OFF



H47-2 High Load Case

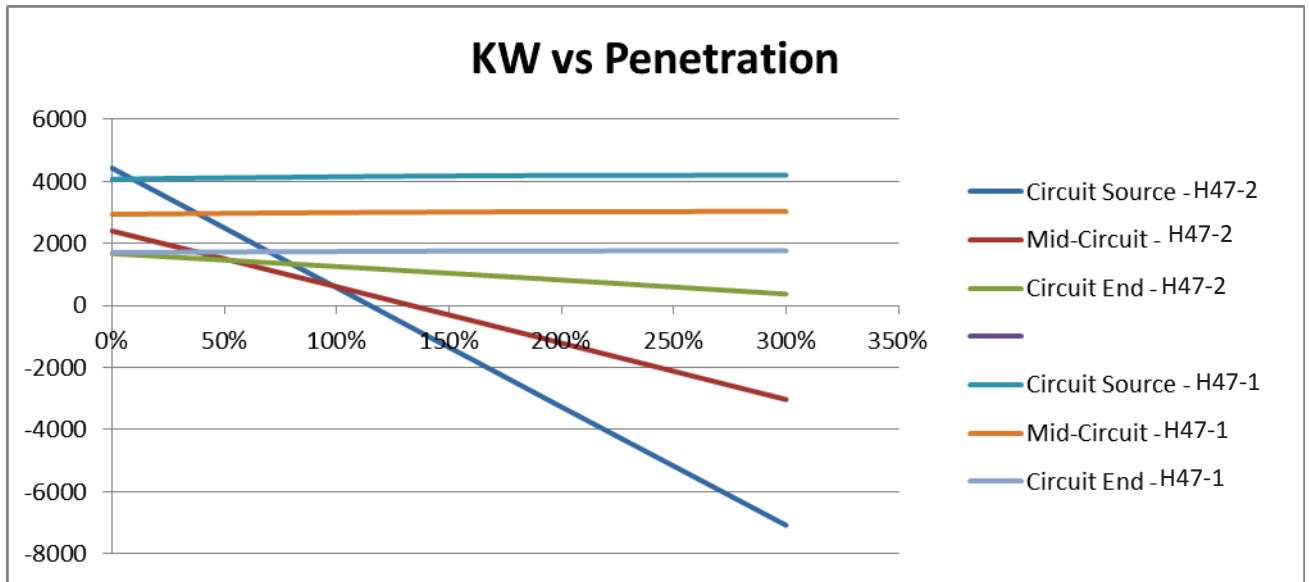

Figure 30 High Load kW VS Penetration - FITS OFF

	KW Into - High Load with a 2*450 CAP added + LTC@9 + (% NEM Penetraion pf = -0.99)											
	0%	20%	40%	60%	80%	100%	120%	140%	160%	180%	200%	300%
Circuit Source - H47-2	4422	3651	2883	2109	1335	573	-199	-970	-1728	-2498	-3266	-7076
Mid-Circuit - H47-2	2398	2041	1684	1322	960	603	241	-123	-481	-845	-1209	-3027
Circuit End - H47-2	1668	1587	1505	1421	1337	1253	1168	1081	996	908	820	370
Circuit Source - H47-1	4066	4085	4102	4117	4131	4144	4155	4165	4173	4180	4186	4195
Mid-Circuit - H47-1	2934	2947	2960	2971	2981	2990	2999	3006	3012	3017	3021	3027
Circuit End - H47-1	1704	1712	1719	1726	1732	1737	1742	1746	1749	1753	1755	1759

Table 15 High Load kW - FITS OFF



Stage 2: NEMs study kvar

H47-2 Day Minimum Load Case

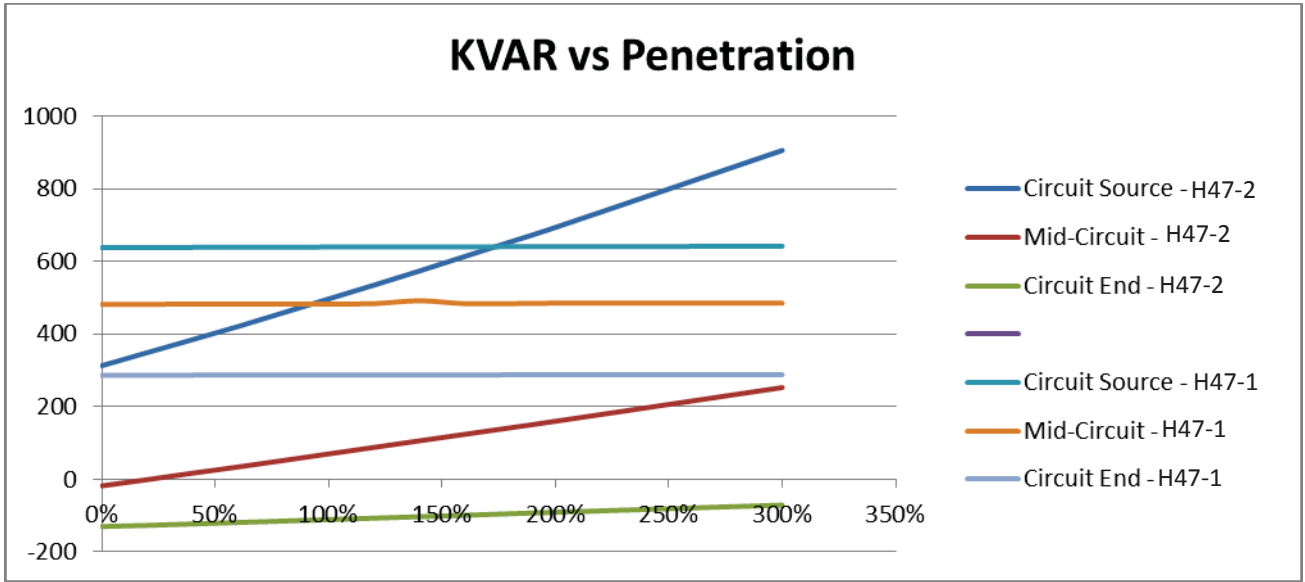

Figure 31 Light Load kvar VS Penetration - FITS OFF

	KVAR Into - Light Load with a 450 CAP added (% NEM Penetration pf @ -0.99)											
	0%	20%	40%	60%	80%	100%	120%	140%	160%	180%	200%	300%
Circuit Source - H47-2	313	349	385	421	459	497	535	574	614	654	694	906
Mid-Circuit - H47-2	-18	-1	17	34	52	70	88	106	124	142	160	253
Circuit End - H47-2	-130	-127	-123	-119	-115	-111	-107	-103	-99	-95	-91	-71
Circuit Source - H47-1	638	638	639	639	639	640	640	640	640	641	641	642
Mid-Circuit - H47-1	482	482	483	483	483	483	484	492	484	484	485	485
Circuit End - H47-1	286	286	287	287	287	287	287	287	287	288	288	288

Table 16 Light Load kvar - FITS OFF





H47-2 Peak Load Case

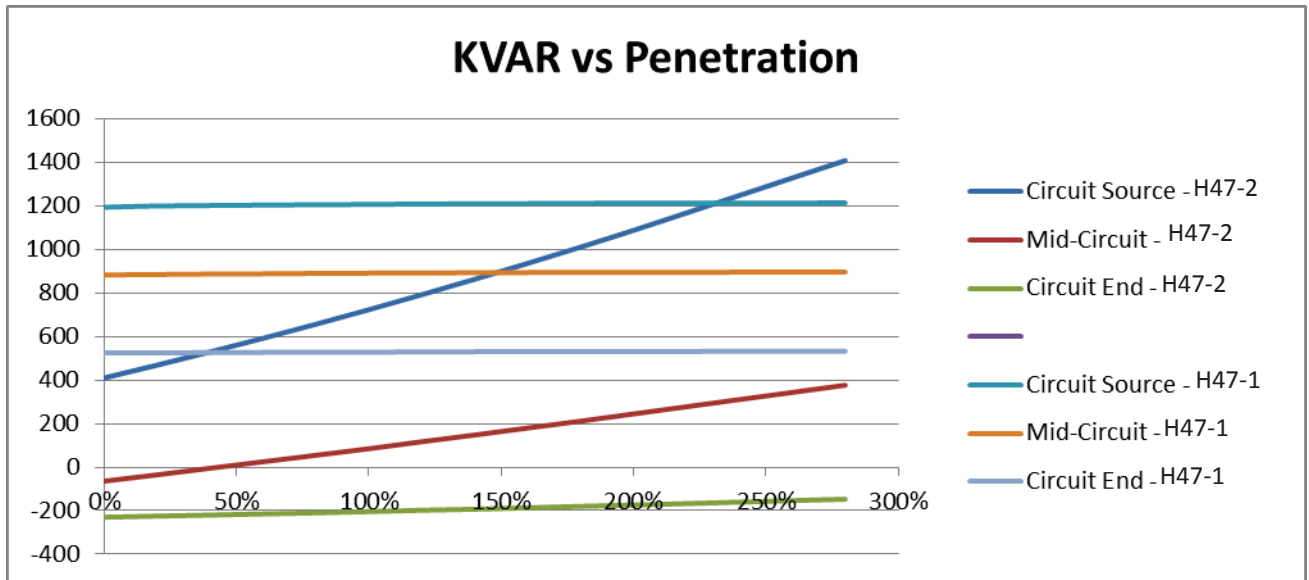

Figure 32 Peak Load kvar VS Penetration - FITS OFF

	KVAR Into - Peak Load with a 450 CAP added (% NEM Penetration pf @ -0.99)											
	0%	20%	40%	60%	80%	100%	120%	140%	160%	180%	200%	280%
Circuit Source - H47-2	410	469	530	592	657	724	793	864	937	1012	1089	1410
Mid-Circuit - H47-2	-64	-35	-5	25	55	85	117	148	180	212	245	377
Circuit End - H47-2	-230	-225	-220	-215	-210	-204	-198	-193	-187	-180	-174	-147
Circuit Source - H47-1	1195	1201	1203	1205	1207	1208	1210	1211	1212	1213	1214	1215
Mid-Circuit - H47-1	884	886	888	889	891	892	893	894	895	895	896	897
Circuit End - H47-1	525	526	527	528	529	529	530	531	531	532	532	533

Table 17 Peak Load kvar - FITS OFF



H47-2 High Load Case

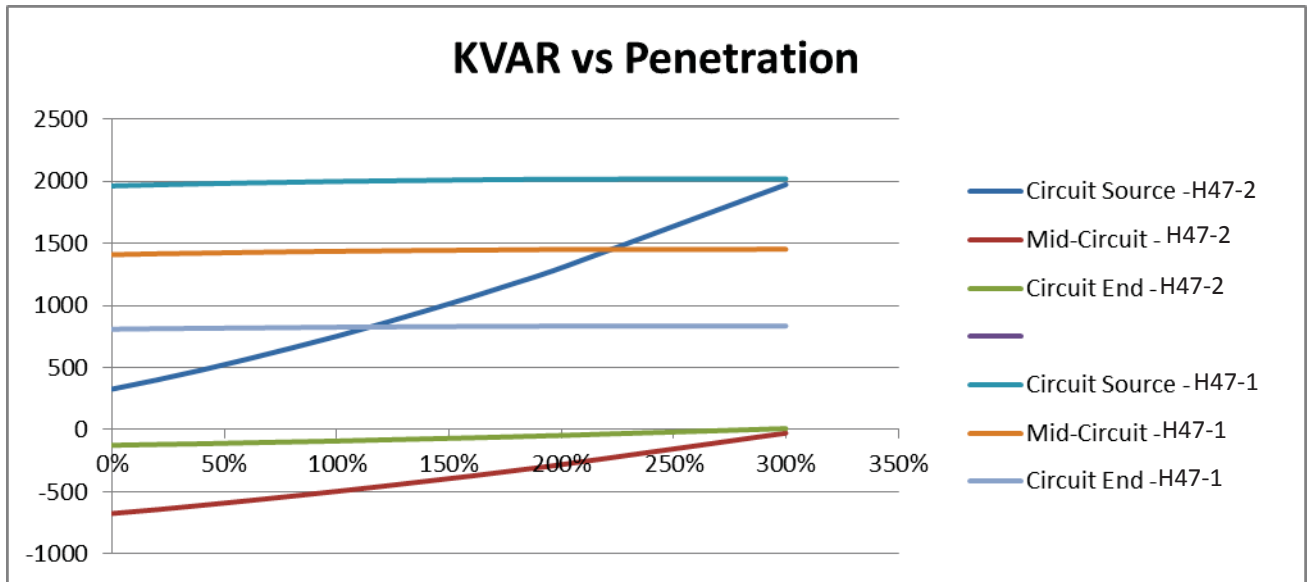

Figure 33 High Load kvar VS Penetration - FITS OFF

KVAR Into - High Load with a 2*450 CAP added + LTC@9 + (% NEM Penetraion pf = -0.99)												
	0%	20%	40%	60%	80%	100%	120%	140%	160%	180%	200%	300%
Circuit Source - H47-2	327	401	481	567	658	752	853	959	1068	1183	1303	1973
Mid-Circuit - H47-2	-674	-643	-608	-572	-535	-496	-456	-414	-372	-327	-281	-27
Circuit End - H47-2	-125	-119	-113	-105	-98	-91	-82	-74	-65	-56	-46	9
Circuit Source - H47-1	1962	1971	1979	1986	1992	1998	2003	2007	2011	2014	2016	2019
Mid-Circuit - H47-1	1409	1416	1421	1427	1432	1436	1439	1443	1445	1448	1450	1452
Circuit End - H47-1	809	813	816	819	822	825	827	829	831	832	833	835

Table 18 High Load kvar - FITS OFF



Stage 3: NEMs study

Voltage - FITs @ 99 pf Consuming

H47-2 Day Minimum Load Case

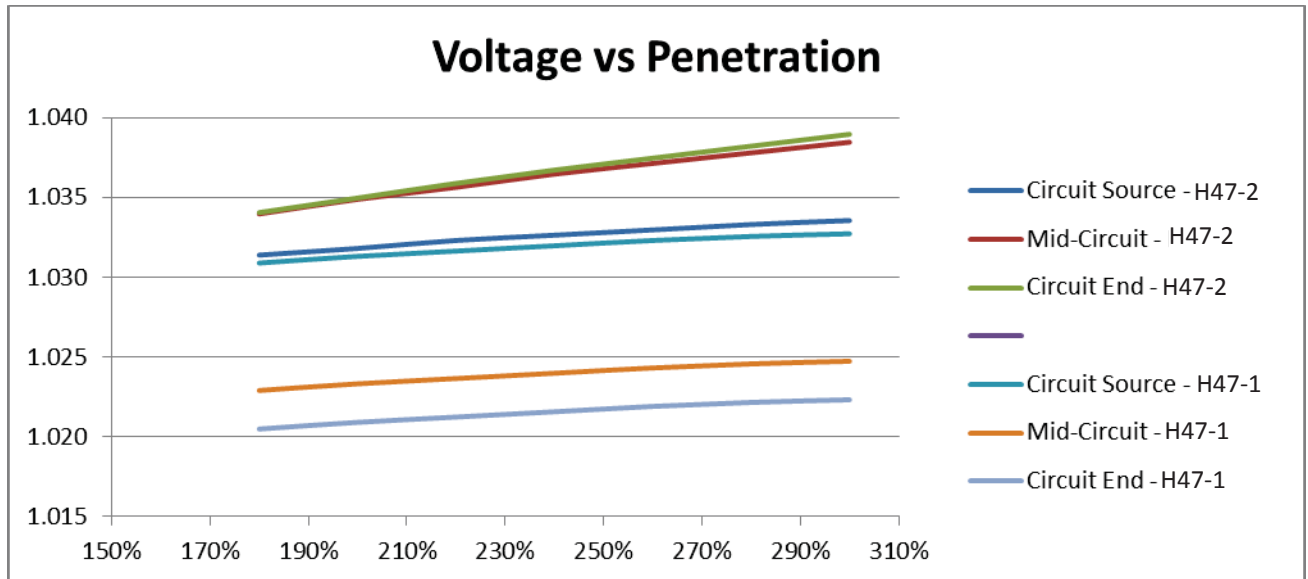

Figure 34 Light Load Voltage VS Penetration - FITS ON -0.99 PF

Voltage Out - Light Load + CAP + FITs (@-0.99) + LTC @ 0 + (% NEM Penetration pf @ -0.99)							
	180%	200%	220%	240%	260%	280%	300%
Circuit Source - H47-2	1.031	1.032	1.032	1.033	1.033	1.033	1.034
Mid-Circuit - H47-2	1.034	1.035	1.036	1.037	1.037	1.038	1.039
Circuit End - H47-2	1.034	1.035	1.036	1.037	1.038	1.038	1.039
Circuit Source - H47-1	1.031	1.031	1.032	1.032	1.032	1.033	1.033
Mid-Circuit - H47-1	1.023	1.023	1.024	1.024	1.024	1.025	1.025
Circuit End - H47-1	1.021	1.021	1.021	1.022	1.022	1.022	1.022

Table 19 Light Load PU Voltage - FITS ON -0.99 PF



 Hawaiian Electric	<i>H47-2 Representative High-Penetration Photo-Voltaic Circuit Study</i>
--	--

H47-2 Peak Load Case

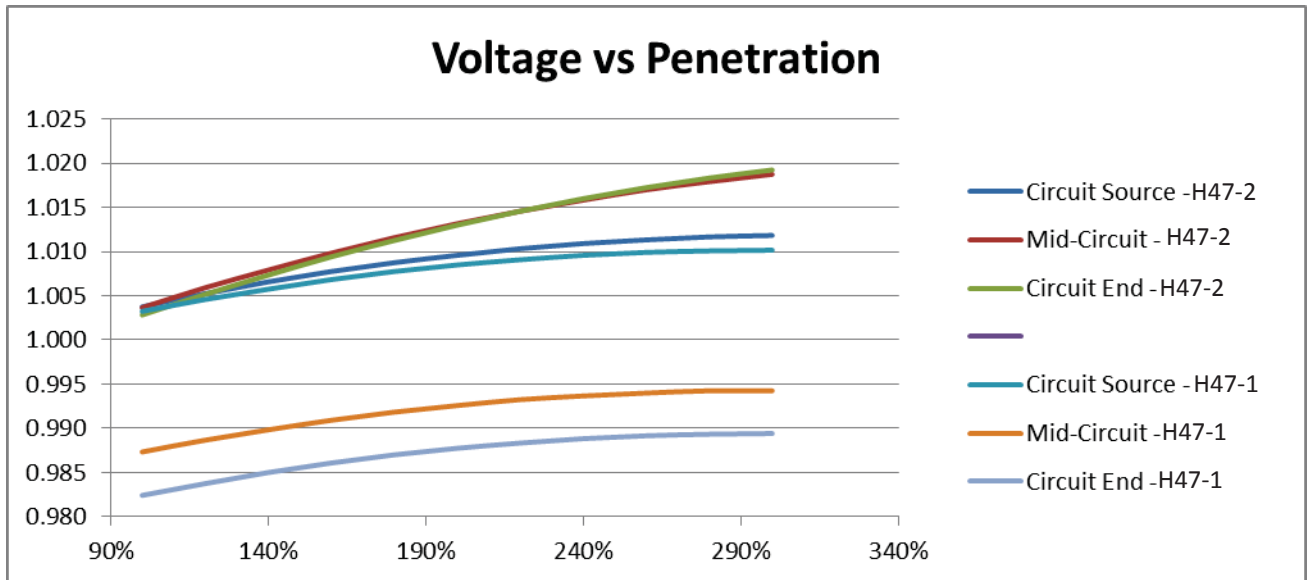

Figure 35 Peak Load Voltage VS Penetration - FITS ON -0.99 PF

	Voltage Out - Peak Load + CAP + FITs (@-0.99) + LTC @ 0 + (% NEM Penetration pf @ -0.99)										
	100%	120%	140%	160%	180%	200%	220%	240%	260%	280%	300%
Circuit Source - H47-2	1.004	1.005	1.007	1.008	1.009	1.010	1.010	1.011	1.011	1.012	1.012
Mid-Circuit - H47-2	1.004	1.006	1.008	1.010	1.012	1.013	1.015	1.016	1.017	1.018	1.019
Circuit End - H47-2	1.003	1.005	1.007	1.009	1.011	1.013	1.015	1.016	1.017	1.018	1.019
Circuit Source - H47-1	1.003	1.005	1.006	1.007	1.008	1.009	1.009	1.010	1.010	1.010	1.010
Mid-Circuit - H47-1	0.987	0.989	0.990	0.991	0.992	0.993	0.993	0.994	0.994	0.994	0.994
Circuit End - H47-1	0.982	0.984	0.985	0.986	0.987	0.988	0.988	0.989	0.989	0.989	0.989

Table 20 Peak Load PU Voltage - FITS ON -0.99 PF

	Hawaiian Electric	<i>H47-2 Representative High-Penetration Photo-Voltaic Circuit Study</i>
---	--------------------------	--

H47-2 High Load Case

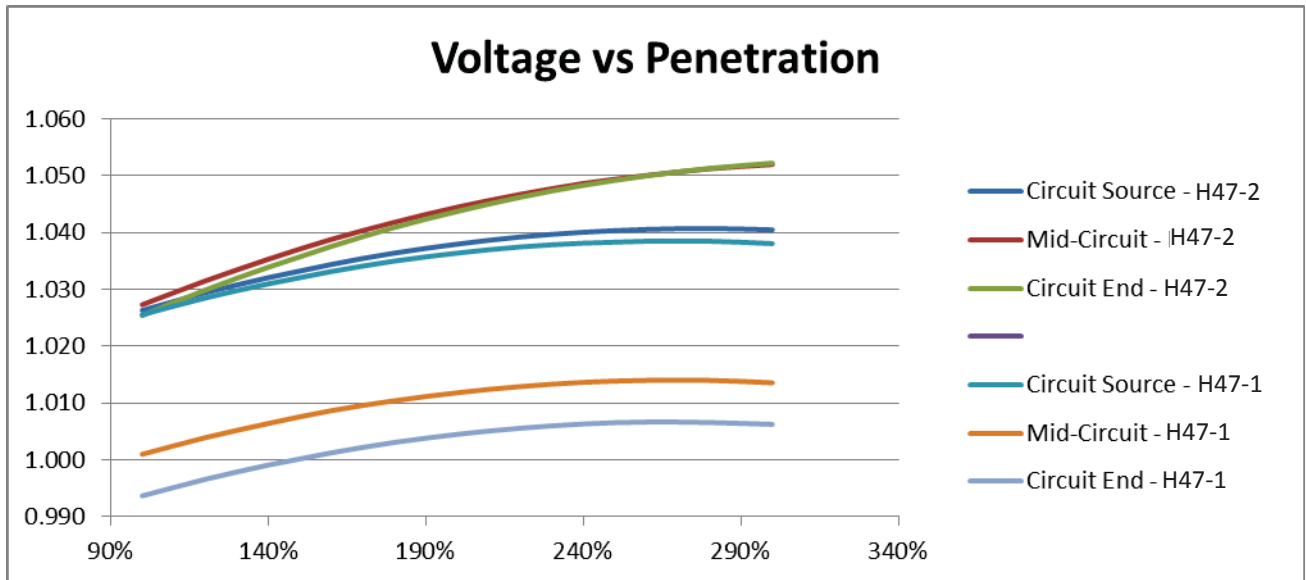

Figure 36 High Load Voltage VS Penetration - FITS ON -0.99 PF

	Voltage Out - HIGH + 2*CAP + FITs (@-0.99) + LTC @ 9 + (% NEM Penetration pf = -0.99)										
	100%	120%	140%	160%	180%	200%	220%	240%	260%	280%	300%
Circuit Source - H47-2	1.026	1.029	1.032	1.034	1.036	1.038	1.039	1.040	1.041	1.041	1.041
Mid-Circuit - H47-2	1.027	1.032	1.035	1.039	1.042	1.045	1.047	1.049	1.050	1.051	1.052
Circuit End - H47-2	1.025	1.030	1.034	1.038	1.041	1.044	1.046	1.048	1.050	1.051	1.052
Circuit Source - H47-1	1.026	1.029	1.031	1.033	1.035	1.036	1.038	1.038	1.039	1.039	1.038
Mid-Circuit - H47-1	1.001	1.004	1.006	1.009	1.010	1.012	1.013	1.014	1.014	1.014	1.014
Circuit End - H47-1	0.994	0.997	0.999	1.001	1.003	1.005	1.006	1.006	1.007	1.007	1.006

Table 21 High Load PU Voltage - FITS ON -0.99 PF



KW - FITs @ 99 pf Consuming

H47-2 Day Minimum Load Case

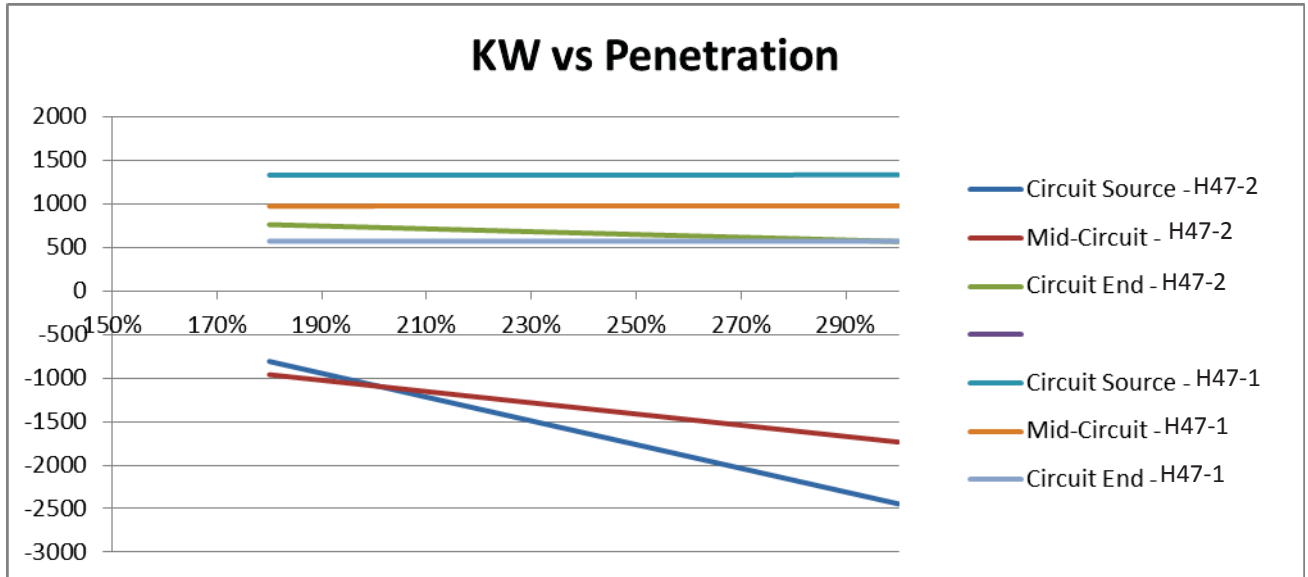



Figure 37 Light Load kW VS Penetration - FITS ON -0.99 PF

	KW Into - Light Load + CAP + FITs (@-0.99) + LTC @ 0 + (% NEM Penetration pf @ -0.99)						
	180%	200%	220%	240%	260%	280%	300%
Circuit Source - H47-2	-807	-1081	-1354	-1627	-1900	-2172	-2444
Mid-Circuit - H47-2	-959	-1088	-1218	-1347	-1476	-1605	-1734
Circuit End - H47-2	765	733	700	668	636	604	571
Circuit Source - H47-1	1334	1334	1335	1335	1335	1336	1336
Mid-Circuit - H47-1	977	978	978	978	978	979	979
Circuit End - H47-1	575	576	576	576	576	576	576

Table 22 Light Load kW - FITS ON -0.99 PF



 Hawaiian Electric	<i>H47-2 Representative High-Penetration Photo-Voltaic Circuit Study</i>
--	--

H47-2 Peak Load Case

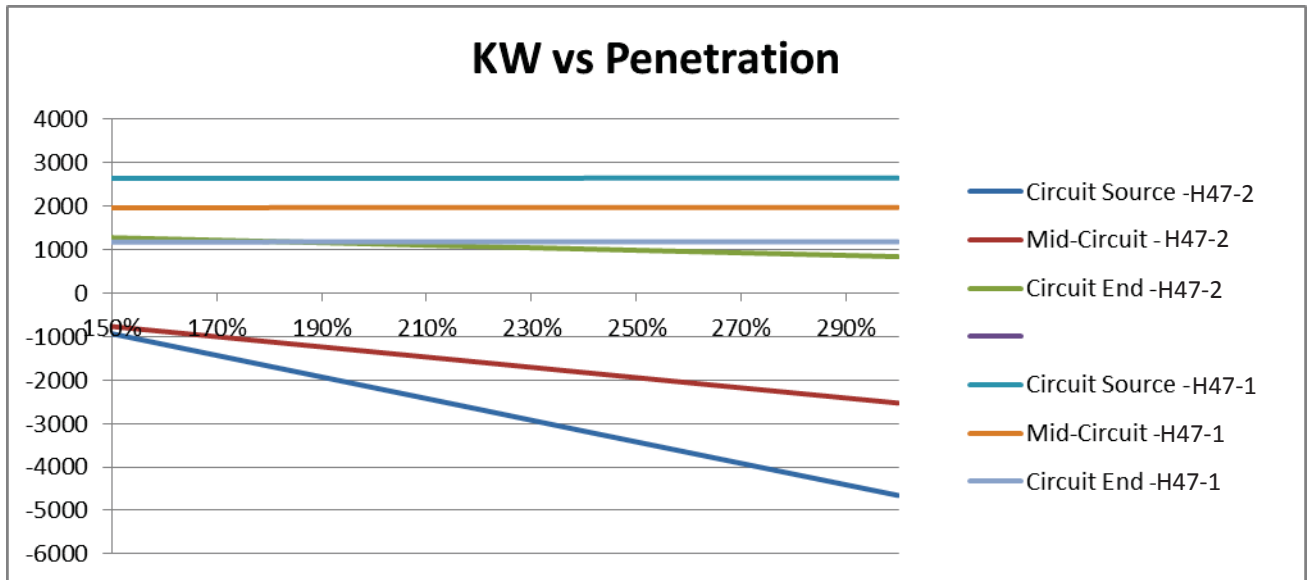



Figure 38 Peak Load kW VS Penetration - FITS ON -0.99 PF

	KW Into - Peak Load + CAP + FITs (@-0.99) + LTC @ 0 + (% NEM Penetration pf @ -0.99)										
	100%	120%	140%	160%	180%	200%	220%	240%	260%	280%	300%
Circuit Source - H47-2	309	-190	-688	-1185	-1682	-2178	-2674	-3174	-3668	-4162	-4654
Mid-Circuit - H47-2	-183	-418	-652	-886	-1120	-1355	-1589	-1826	-2061	-2295	-2530
Circuit End - H47-2	1415	1358	1301	1244	1187	1129	1071	1013	954	896	837
Circuit Source - H47-1	2627	2631	2634	2636	2638	2640	2641	2643	2643	2644	2644
Mid-Circuit - H47-1	1957	1959	1961	1963	1965	1966	1967	1968	1968	1969	1969
Circuit End - H47-1	1170	1172	1173	1174	1175	1176	1176	1177	1177	1178	1178

Table 23 Peak Load kW - FITS ON -0.99 PF

 Hawaiian Electric	<i>H47-2 Representative High-Penetration Photo-Voltaic Circuit Study</i>
--	--

H47-2 High Load Case

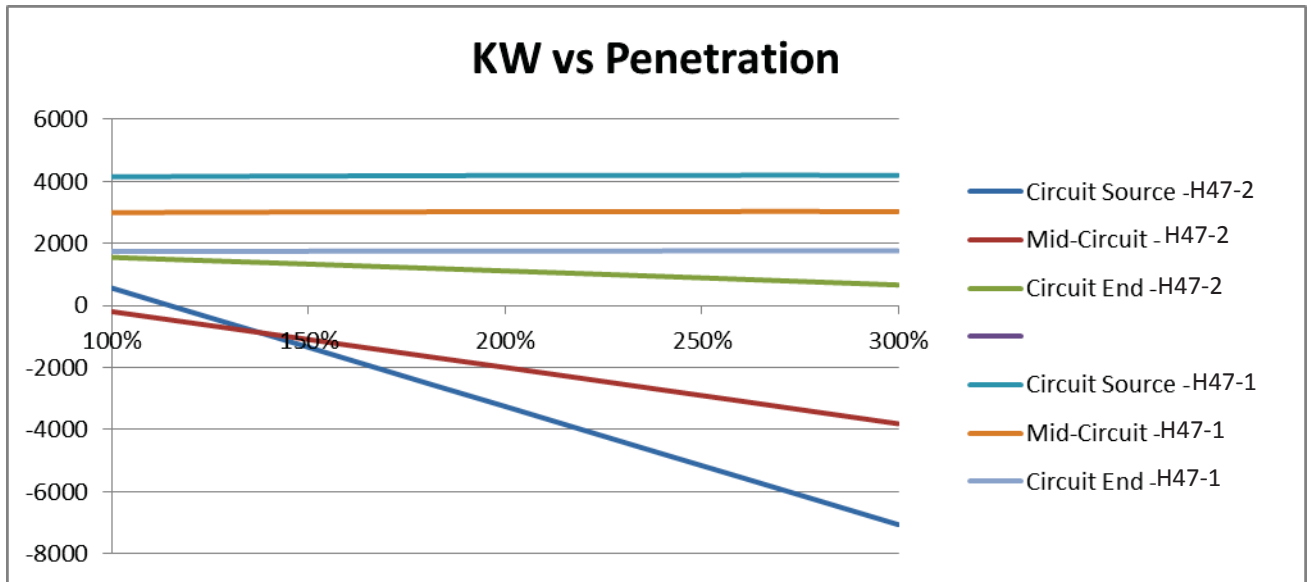

Figure 39 High Load kW VS Penetration - FITS ON -0.99 PF

	KW Into - HIGH + 2*CAP + FITs (@-0.99) + LTC @ 9 + (% NEM Penetration pf = -0.99)										
	100%	120%	140%	160%	180%	200%	220%	240%	260%	280%	300%
Circuit Source - H47-2	560	-205	-965	-1731	-2497	-3251	-4015	-4778	-5532	-6295	-7056
Mid-Circuit - H47-2	-199	-557	-915	-1276	-1637	-1994	-2356	-2719	-3078	-3443	-3807
Circuit End - H47-2	1547	1461	1376	1288	1200	1113	1024	934	844	752	660
Circuit Source - H47-1	4143	4154	4163	4171	4178	4183	4187	4190	4191	4191	4190
Mid-Circuit - H47-1	2990	2998	3005	3010	3015	3019	3022	3024	3025	3025	3024
Circuit End - H47-1	1737	1741	1745	1749	1752	1754	1755	1757	1757	1757	1757

Table 24 High Load kW - FITS ON -0.99 PF



kvar - FITs @ 99 pf Consuming

H47-2 Day Minimum Load Case

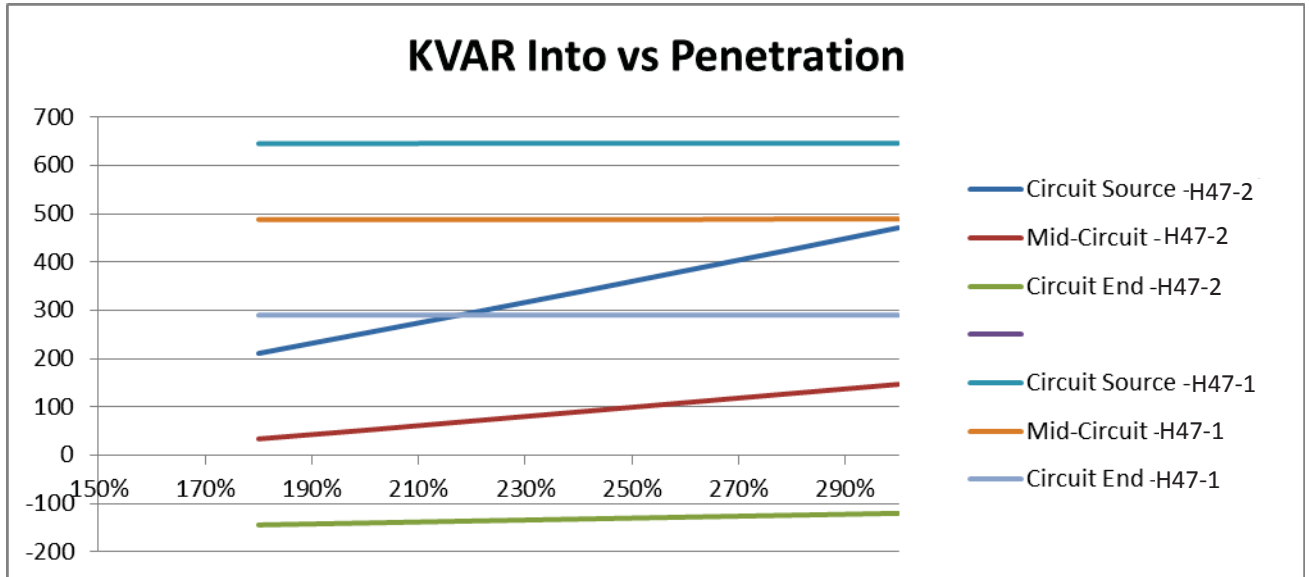

Figure 40 Light Load kvar VS Penetration - FITS ON -0.99 PF

	KVAR Into - Light Load + CAP + FITs (@-0.99) + LTC @ 0 + (% NEM Penetration pf @ -0.99)						
	180%	200%	220%	240%	260%	280%	300%
Circuit Source - H47-2	211	253	295	338	382	426	471
Mid-Circuit - H47-2	34	52	71	90	109	128	147
Circuit End - H47-2	-144	-140	-136	-132	-128	-124	-120
Circuit Source - H47-1	645	645	646	646	646	646	646
Mid-Circuit - H47-1	488	488	488	488	488	489	489
Circuit End - H47-1	290	290	290	290	290	290	290

Table 25 Light Load kvar - FITS ON -0.99 PF



H47-2 Peak Load Case

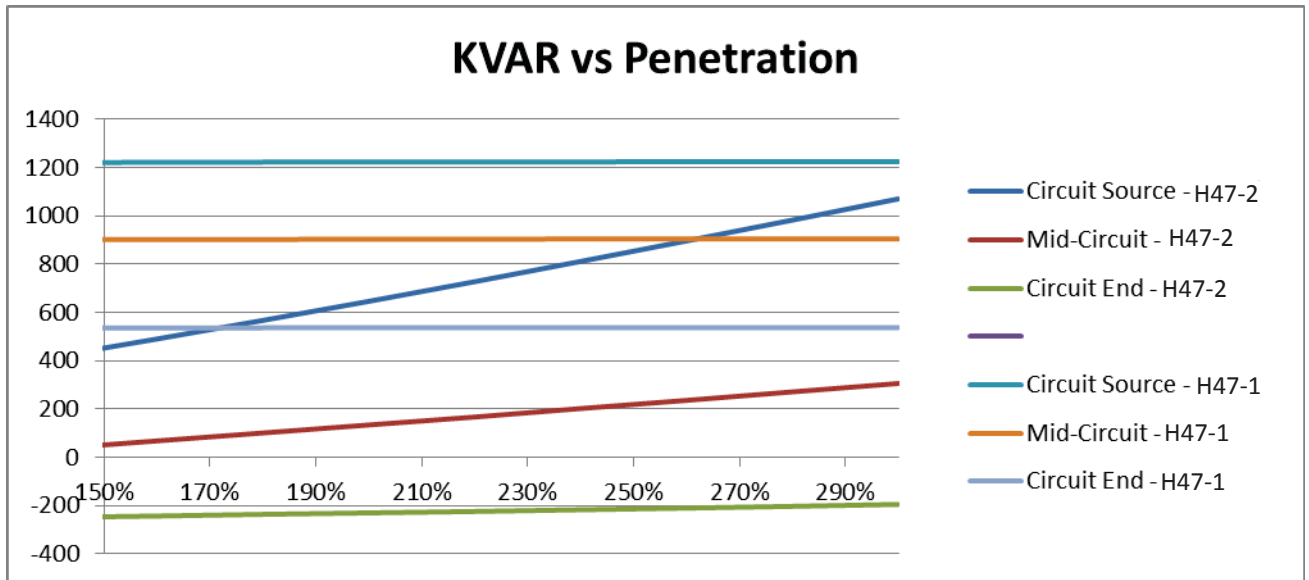



Figure 41 Peak Load kvar VS Penetration - FITS ON -0.99 PF

	KVAR Into - Peak Load + CAP + FITs (@-0.99) + LTC @ 0 + (% NEM Penetration pf @ -0.99)										
	100%	120%	140%	160%	180%	200%	220%	2.4	2.6	2.8	3
Circuit Source - H47-2	270	342	415	490	567	646	727	811	896	982	1070
Mid-Circuit - H47-2	-28	3	35	68	101	134	167	202	236	271	306
Circuit End - H47-2	-260	-255	-249	-243	-236	-230	-224	-217	-210	-203	-195
Circuit Source - H47-1	1217	1219	1220	1221	1222	1222	1223	1223	1224	1224	1224
Mid-Circuit - H47-1	899	900	901	901	902	903	903	904	904	904	904
Circuit End - H47-1	534	534	535	535	536	536	536	537	537	537	537

Table 26 Peak Load kvar - FITS ON -0.99 PF

 Hawaiian Electric	<i>H47-2 Representative High-Penetration Photo-Voltaic Circuit Study</i>
--	--

H47-2 High Load Case

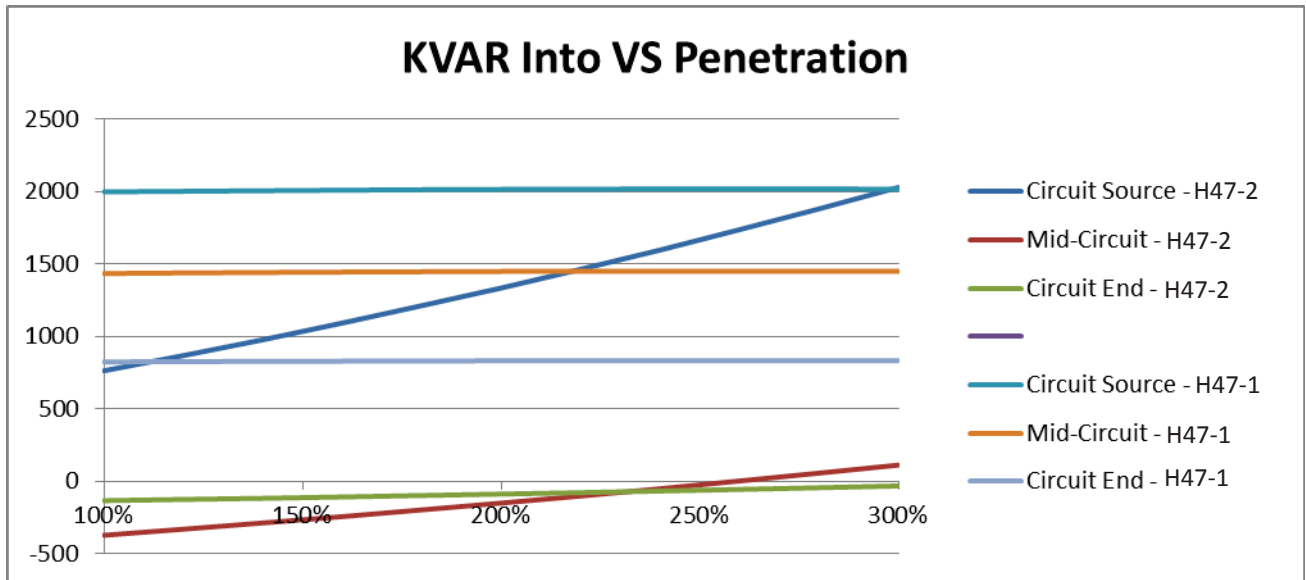

Figure 42 High Load kvar VS Penetration - FITS ON -0.99 PF

	KVAR Into - HIGH + 2*CAP + FITs (@-0.99) + LTC @ 9 + (% NEM Penetration pf = -0.99)										
	100%	120%	140%	160%	180%	200%	220%	240%	260%	280%	300%
Circuit Source - H47-2	764	869	978	1093	1213	1335	1464	1597	1737	1881	2029
Mid-Circuit - H47-2	-371	-329	-286	-242	-196	-149	-100	-50	4	58	113
Circuit End - H47-2	-132	-124	-116	-107	-97	-87	-77	-66	-55	-43	-31
Circuit Source - H47-1	1998	2002	2006	2010	2013	2015	2017	2018	2018	2018	2017
Mid-Circuit - H47-1	1435	1439	1442	1445	1447	1449	1450	1451	1451	1451	1450
Circuit End - H47-1	825	827	829	830	831	833	833	834	834	834	834

Table 27 High Load kvar - FITS ON -0.99 PF



Voltage - FITs @ 95 pf Producing vars

H47-2 Day Minimum Load Case

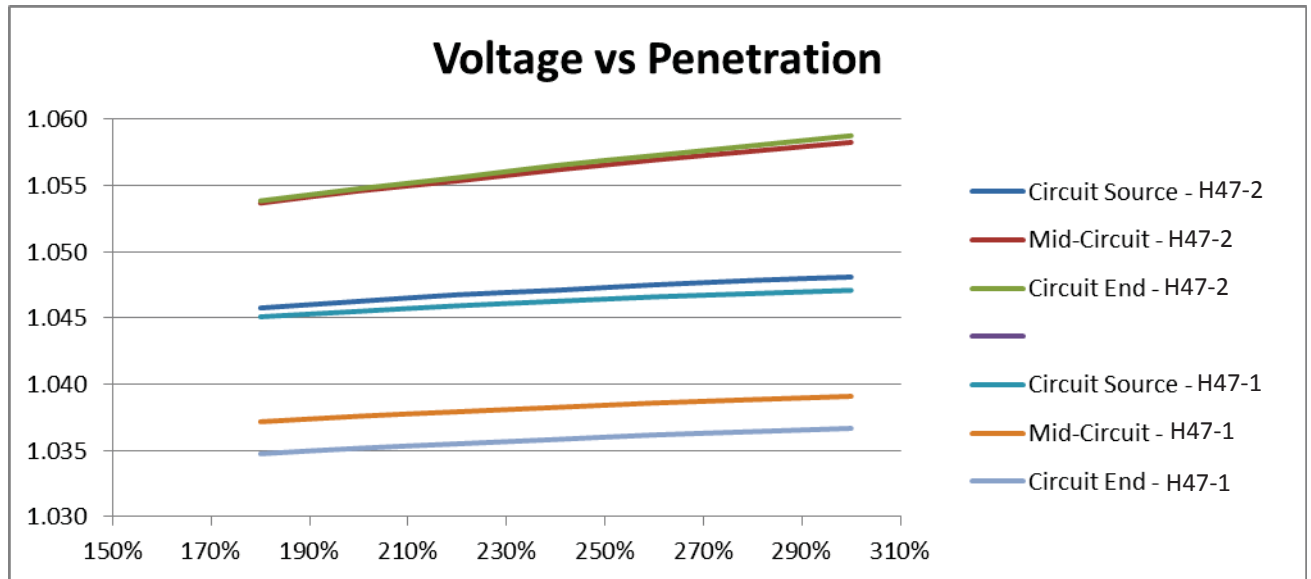

Figure 43 Light Load Voltage VS Penetration - FITS ON 0.95 PF

	Voltage Out - Light Load + CAP + FITs (@+0.95) + LTC @ 0 + (% NEM Penetration pf @ -0.99)						
	180%	200%	220%	240%	260%	280%	300%
Circuit Source - H47-2	1.046	1.046	1.047	1.047	1.048	1.048	1.048
Mid-Circuit - H47-2	1.054	1.055	1.055	1.056	1.057	1.058	1.058
Circuit End - H47-2	1.054	1.055	1.056	1.057	1.057	1.058	1.059
Circuit Source - H47-1	1.045	1.046	1.046	1.046	1.047	1.047	1.047
Mid-Circuit - H47-1	1.037	1.038	1.038	1.038	1.039	1.039	1.039
Circuit End - H47-1	1.035	1.035	1.036	1.036	1.036	1.036	1.037

Table 28 Light Load PU Voltage - FITS ON 0.95 PF

H47-2 Peak Load Case





Hawaiian Electric

H47-2 Representative High-Penetration Photo-Voltaic Circuit Study

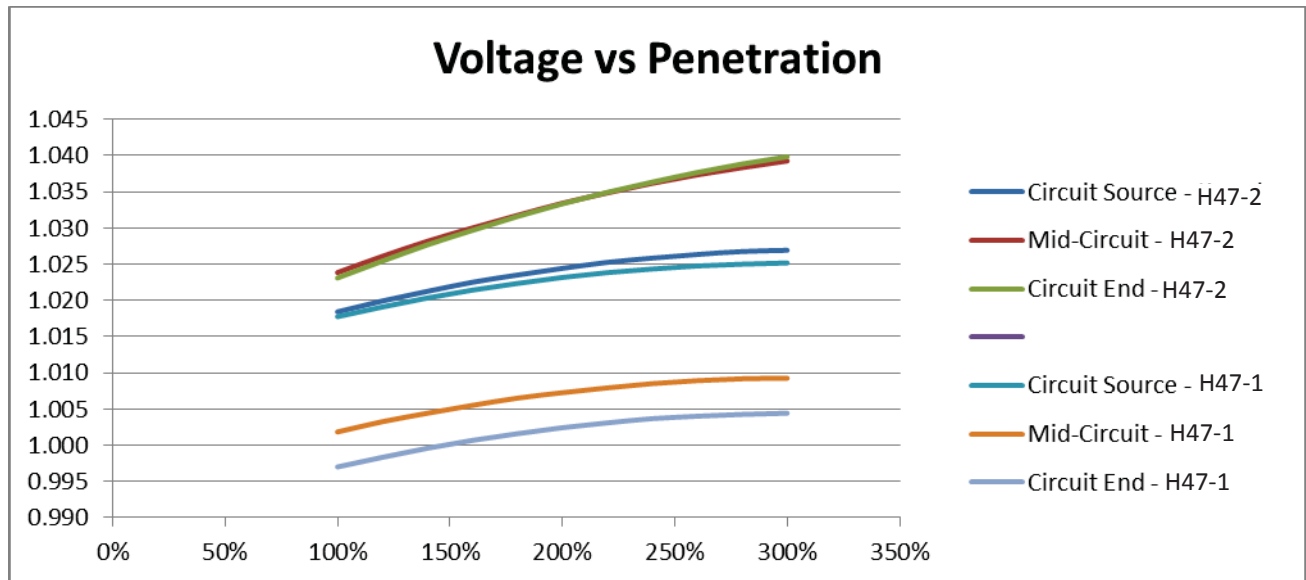

Figure 44 Peak Load Voltage VS Penetration - FITS ON 0.95 PF

	Voltage Out - Peak Load + CAP + FITs (@+0.95) + LTC @ 0 + (% NEM Penetration pf @ -0.99)										
	100%	120%	140%	160%	180%	200%	220%	240%	260%	280%	300%
Circuit Source - H47-2	1.018	1.020	1.021	1.023	1.024	1.024	1.025	1.026	1.026	1.027	1.027
Mid-Circuit - H47-2	1.024	1.026	1.028	1.030	1.032	1.033	1.035	1.036	1.037	1.038	1.039
Circuit End - H47-2	1.023	1.025	1.028	1.030	1.032	1.033	1.035	1.036	1.038	1.039	1.040
Circuit Source - H47-1	1.018	1.019	1.020	1.021	1.022	1.023	1.024	1.024	1.025	1.025	1.025
Mid-Circuit - H47-1	1.002	1.003	1.004	1.006	1.007	1.007	1.008	1.009	1.009	1.009	1.009
Circuit End - H47-1	0.997	0.998	1.000	1.001	1.002	1.002	1.003	1.004	1.004	1.004	1.004

Table 29 Peak Load PU Voltage - FITS ON 0.95 PF



Filename: H47-2_Final.Docx

Modified: 2/25/14 Page: 99 of 113



H47-2 High Load Case

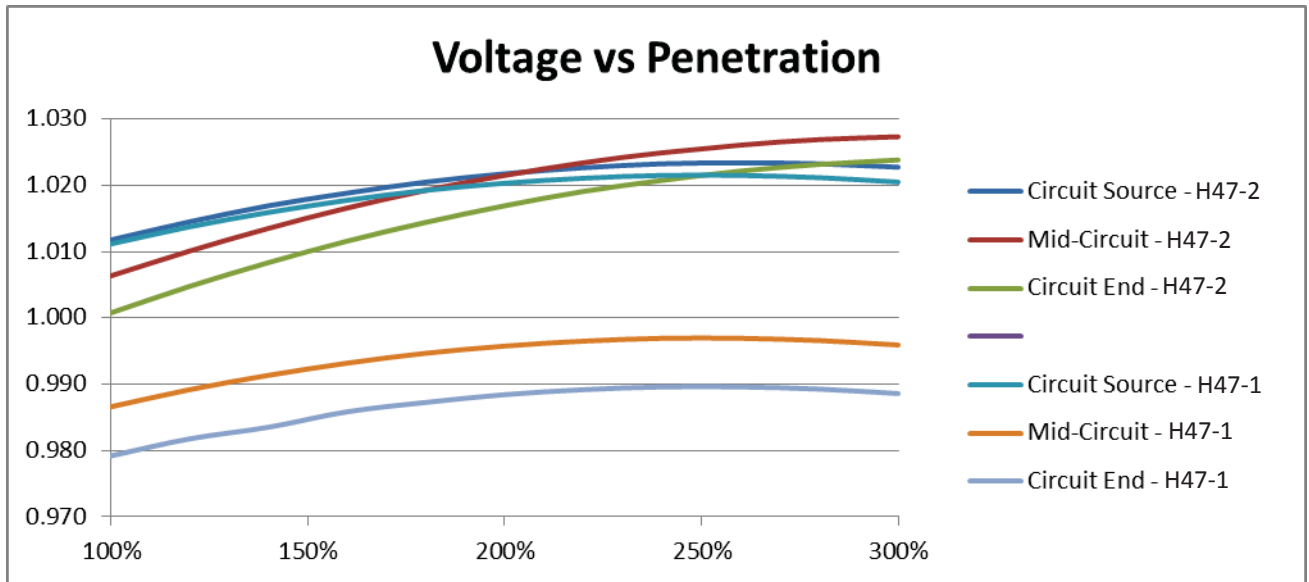



Figure 45 High Load Voltage VS Penetration - FITS ON 0.95 PF

	Voltage Out - HIGH Load + FITs (@+0.95) + LTC @ 9 + (% NEM Penetration pf = -0.99)										
	100%	120%	140%	160%	180%	200%	220%	240%	260%	280%	300%
Circuit Source - H47-2	1.012	1.015	1.017	1.019	1.021	1.022	1.023	1.023	1.023	1.023	1.023
Mid-Circuit - H47-2	1.006	1.010	1.014	1.017	1.019	1.022	1.023	1.025	1.026	1.027	1.027
Circuit End - H47-2	1.001	1.005	1.008	1.012	1.014	1.017	1.019	1.021	1.022	1.023	1.024
Circuit Source - H47-1	1.011	1.014	1.016	1.018	1.019	1.020	1.021	1.022	1.022	1.021	1.021
Mid-Circuit - H47-1	0.987	0.989	0.991	0.993	0.995	0.996	0.997	0.997	0.997	0.997	0.996
Circuit End - H47-1	0.979	0.982	0.984	0.986	0.987	0.988	0.989	0.990	0.990	0.989	0.989

Table 30 High Load PU Voltage - FITS ON 0.95 PF

 Hawaiian Electric	<i>H47-2 Representative High-Penetration Photo-Voltaic Circuit Study</i>
--	--

KW - FITs @ 95 pf Producing vars

H47-2 Day Minimum Load Case

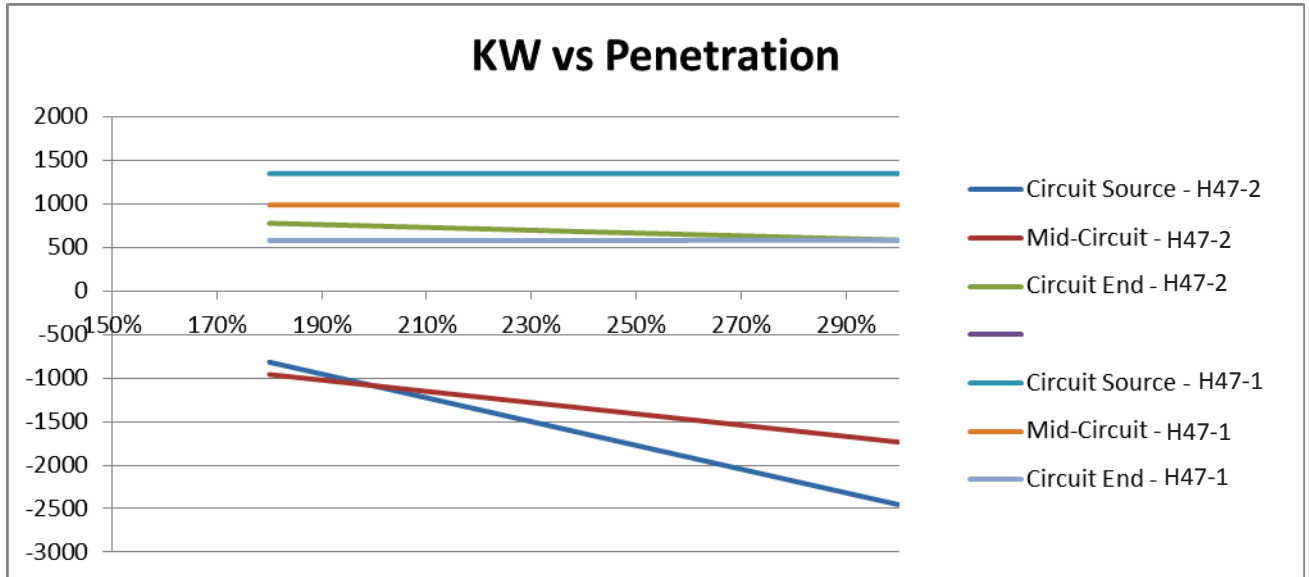



Figure 46 Light Load kW VS Penetration - FITS ON 0.95 PF

	KW Into - Light Load + CAP + FITs (@+0.95) + LTC @ 0 + (% NEM Penetration pf @ -0.99)						
	180%	200%	220%	240%	260%	280%	300%
Circuit Source - H47-2	-815	-1089	-1362	-1636	-1909	-2182	-2452
Mid-Circuit - H47-2	-957	-1086	-1216	-1345	-1475	-1604	-1734
Circuit End - H47-2	781	749	717	684	652	620	587
Circuit Source - H47-1	1351	1351	1352	1352	1353	1353	1353
Mid-Circuit - H47-1	989	990	990	990	991	991	991
Circuit End - H47-1	583	583	583	583	584	584	584

Table 31 Light Load kW - FITS ON 0.95 PF

H47-2 Peak Load Case

 Hawaiian Electric	<i>H47-2 Representative High-Penetration Photo-Voltaic Circuit Study</i>
--	--

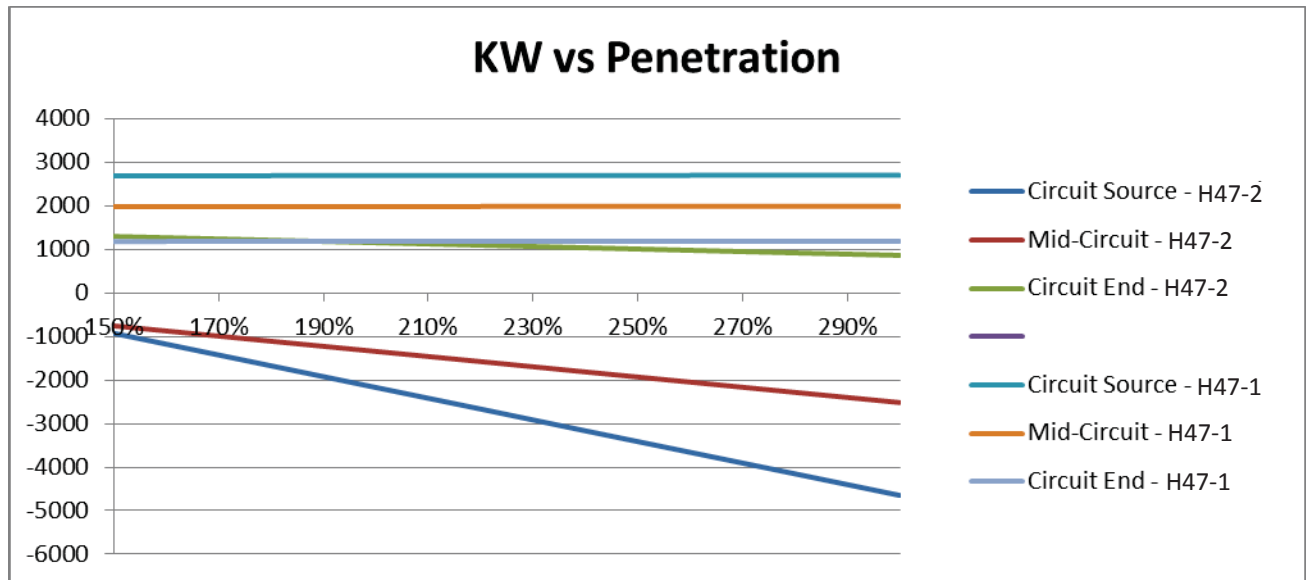



Figure 47 Peak Load kW VS Penetration - FITS ON 0.95 PF

	KW Into - Peak Load + CAP + FITs (@+0.95) + LTC @ 0 + (% NEM Penetration pf @ -0.99)										
	100%	120%	140%	160%	180%	200%	220%	240%	260%	280%	300%
Circuit Source - H47-2	324	-176	-674	-1172	-1670	-2166	-2662	-3164	-3658	-4152	-4646
Mid-Circuit - H47-2	-165	-399	-634	-868	-1103	-1337	-1572	-1810	-2044	-2279	-2514
Circuit End - H47-2	1446	1389	1332	1275	1218	1160	1103	1044	986	927	869
Circuit Source - H47-1	2691	2694	2697	2699	2702	2704	2705	2707	2708	2708	2708
Mid-Circuit - H47-1	1982	1985	1987	1989	1990	1992	1993	1994	1995	1995	1995
Circuit End - H47-1	1186	1187	1188	1190	1191	1191	1192	1193	1193	1193	1194

Table 32 Peak Load kW - FITS ON 0.95 PF

 Hawaiian Electric	<i>H47-2 Representative High-Penetration Photo-Voltaic Circuit Study</i>
--	--

H47-2 High Load Case

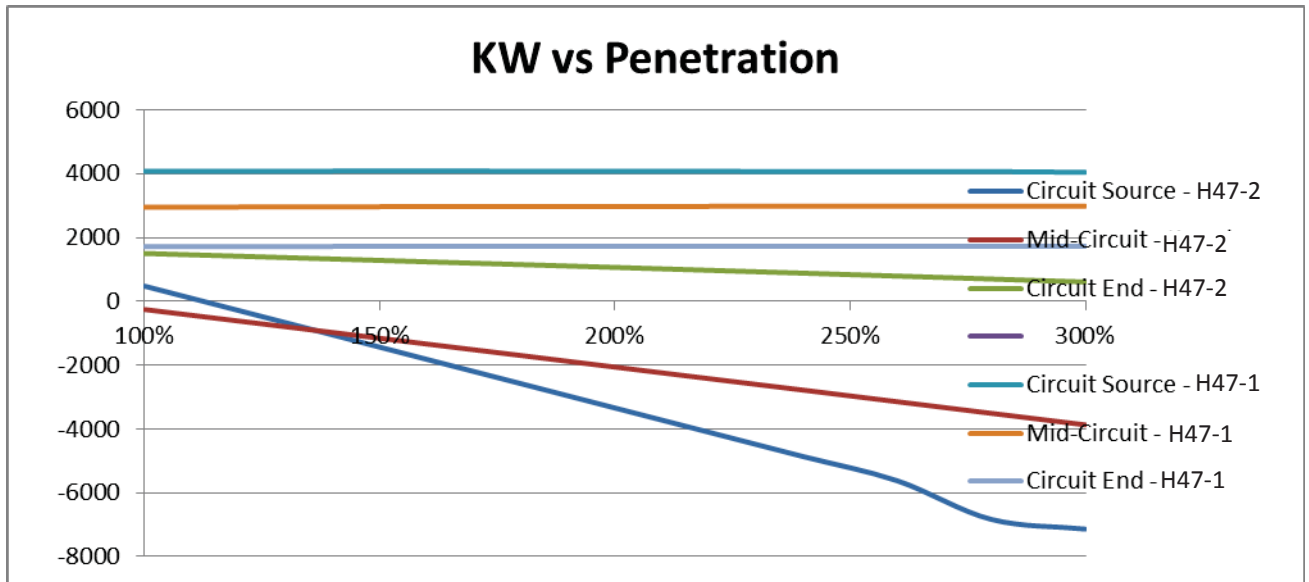



Figure 48 High Load kW VS Penetration - FITS ON 0.95 PF

	KW Into - HIGH Load + FITs (@+0.95) + LTC @ 9 + (% NEM Penetration pf = -0.99)										
	100%	120%	140%	160%	180%	200%	220%	240%	260%	280%	300%
Circuit Source - H47-2	478	-287	-1052	-1817	-2579	-3342	-4104	-4863	-5623	-6832	-7138
Mid-Circuit - H47-2	-254	-614	-974	-1335	-1696	-2058	-2420	-2781	-3144	-3507	-3869
Circuit End - H47-2	1503	1417	1329	1242	1153	1064	974	884	793	701	609
Circuit Source - H47-1	4079	4082	4083	4089	4081	4079	4075	4069	4070	4068	4046
Mid-Circuit - H47-1	2952	2959	2965	2970	2973	2976	2978	2979	2979	2979	2987
Circuit End - H47-1	1715	1719	1722	1725	1727	1729	1730	1730	1731	1730	1729

Table 33 High Load kW - FITS ON 0.95 PF

 Hawaiian Electric	<i>H47-2 Representative High-Penetration Photo-Voltaic Circuit Study</i>
--	--

kvar - FITs @ 95 pf Producing vars

H47-2 Day Minimum Load Case

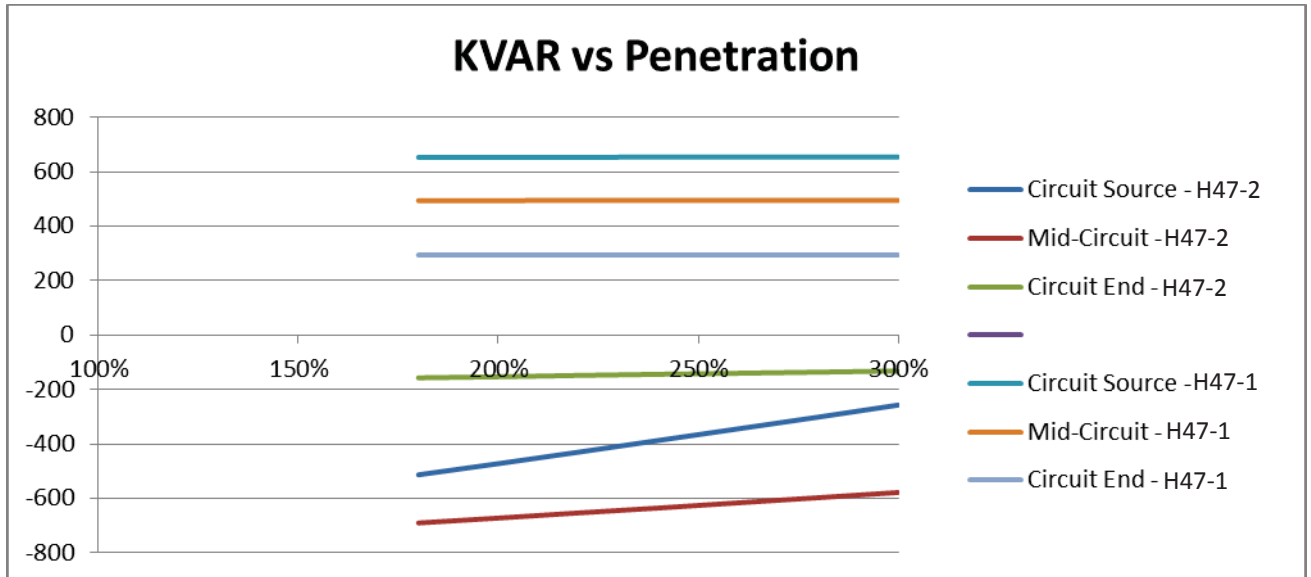

Figure 49 Light Load kvar VS Penetration - FITS ON 0.95 PF

	KVAR Into - Light Load + CAP + FITs (@+0.95) + LTC @ 0 + (% NEM Penetration pf @ -0.99)						
	180%	200%	220%	240%	260%	280%	300%
Circuit Source - H47-2	-513	-472	-430	-387	-344	-301	-257
Mid-Circuit - H47-2	-690	-672	-653	-635	-616	-597	-578
Circuit End - H47-2	-157	-153	-148	-144	-140	-136	-132
Circuit Source - H47-1	653	653	653	654	654	654	654
Mid-Circuit - H47-1	494	494	495	495	495	495	495
Circuit End - H47-1	294	294	294	294	294	294	294

Table 34 Light Load kvar - FITS ON 0.95 PF



H47-2 Peak Load Case

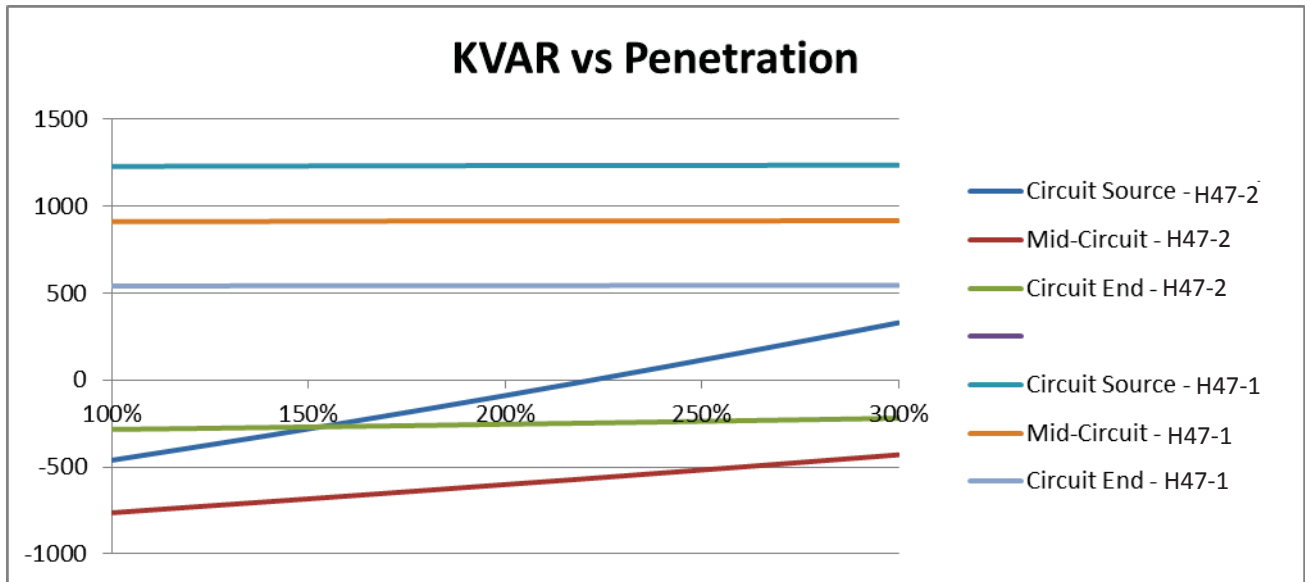



Figure 50 Peak Load kvar VS Penetration - FITS ON 0.95 PF

	KVAR Into - Peak Load + CAP + FITs (@+0.95) + LTC @ 0 + (% NEM Penetration pf @ -0.99)										
	100%	120%	140%	160%	180%	200%	220%	240%	260%	280%	300%
Circuit Source - H47-2	-461	-390	-318	-243	-167	-89	-9	73	157	242	329
Mid-Circuit - H47-2	-763	-731	-699	-667	-634	-601	-568	-534	-500	-465	-430
Circuit End - H47-2	-284	-279	-273	-267	-261	-254	-248	-241	-234	-227	-220
Circuit Source - H47-1	1228	1229	1230	1231	1232	1233	1234	1234	1234	1235	1235
Mid-Circuit - H47-1	910	911	912	913	914	914	915	915	915	916	916
Circuit End - H47-1	541	541	542	542	543	543	543	544	544	544	544

Table 35 Peak Load kvar - FITS ON 0.95 PF

 Hawaiian Electric	<p>H47-2 Representative High-Penetration Photo-Voltaic Circuit Study</p>
--	--

H47-2 High Load Case

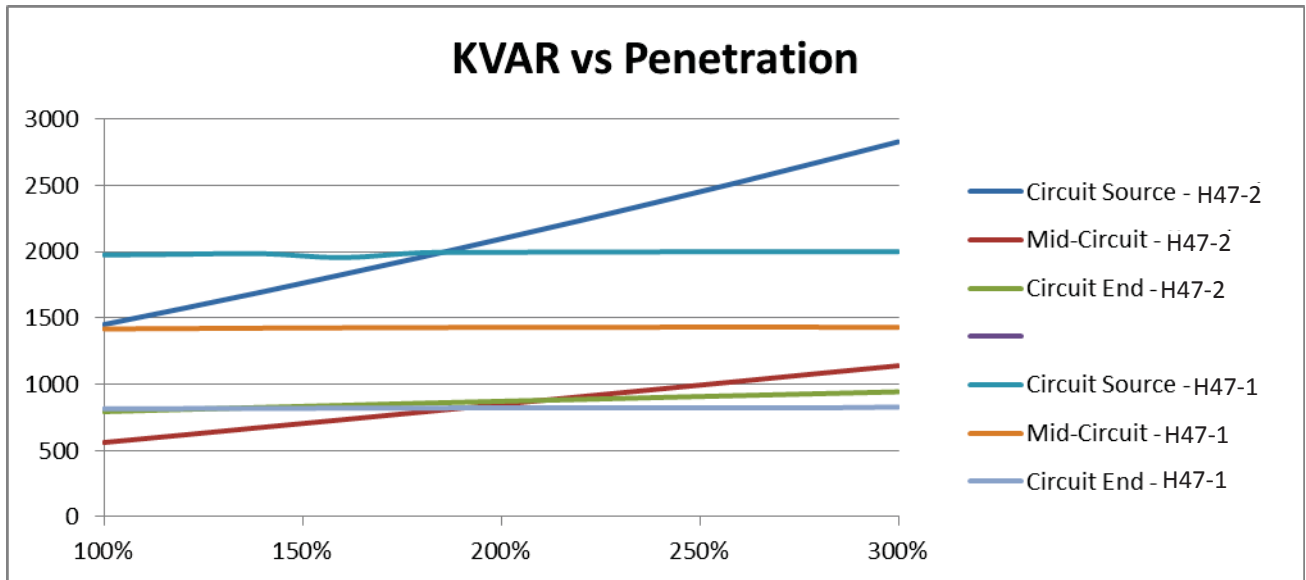



Figure 51 High Load kvar VS Penetration - FITS ON 0.95 PF

	KVAR Into - HIGH Load + FITs (@+0.95) + LTC @ 9 + (% NEM Penetration pf = -0.99)										
	100%	120%	140%	160%	180%	200%	220%	240%	260%	280%	300%
Circuit Source - H47-2	1450	1572	1697	1827	1959	2096	2235	2379	2525	2676	2829
Mid-Circuit - H47-2	560	617	675	732	790	848	906	964	1022	1081	1139
Circuit End - H47-2	793	809	825	840	856	871	885	900	914	928	942
Circuit Source - H47-1	1975	1980	1985	1955	1992	1995	1997	1998	1998	1998	2000
Mid-Circuit - H47-1	1417	1420	1423	1425	1427	1429	1429	1430	1430	1430	1429
Circuit End - H47-1	814	816	817	819	820	822	821	821	821	821	827

Table 36 High Load kvar - FITS ON 0.95 PF

 <p>Hawaiian Electric</p>	<p><i>H47-2 Representative High-Penetration Photo-Voltaic Circuit Study</i></p>
---	---

This page intentionally left blank.

 <p>UC SYNERGETIC <i>Innovative Thinking. Engineered Solutions.</i></p>	<p>Filename: H47-2_Final.Docx Modified: 2/25/14 Page: 107 of 113</p>
---	--

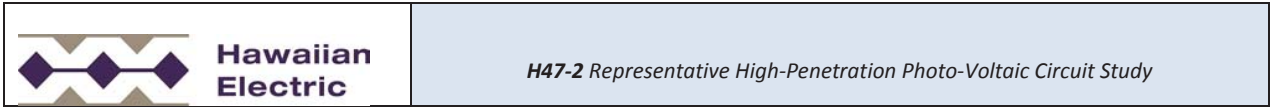

Appendix E – More on Flicker

In order to estimate the impact of adding small Solar up to 100% two data models were prepared. Flicker and voltage regulation are strongly related to Stiffness Factor (SF). A SF of greater than 50 has an increased probability of serious issues⁷.

Two data models were prepared using the Hawaiian Electric Company “Renewable Checklist Rev G.xltx” which includes a stiffness calculator sheet to evaluate SF under different scenarios.

Considering the worst case scenario two conservative equations were drawn from the results of the two data models. First equation tells the maximum solar generation that feeds back into 46 kV systems before the SF becomes unacceptable. The second equation does the same for 12 kV systems.

Second equation helps in estimating the impacts on 12 kV systems.

Equation 1

$$P_{dg} = -1600 \ln(Z_{pu}) - 2100 \quad 46 \text{ kV}$$

Equation 2

$$P_{dg} = 200 / (Z_{pu}) \quad 12 \text{ kV}$$

(P_{dg}= Solar-Load)

(Z_{pu} = Impedance in per-unit)

The data models were prepared by modeling various lengths and wire types for 12 kV and 46 kV lines.

Then the maximum P_{dg} load was found which corresponds to a SF of 50 for each line length and wire type. Regression was used to fit an equation to the results in order to find the simplest equations possible to estimate the maximum allowable back-feed solar generation for any point along a power line.

The 46 kV Equation 1 is used to evaluate total circuit penetration. Before using Equation 1 it is important to discuss SF and how it is calculated. The equation for SF is:

⁷ “Interconnecting Distributed Generation to the Power System,” Phil Barker, Nova Energy Specialists, LLC. 2012

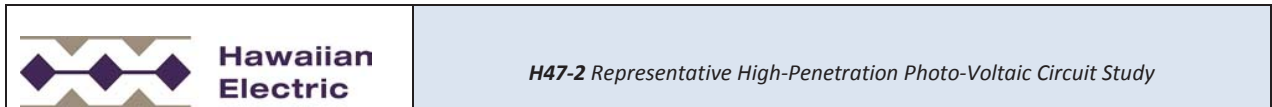

Equation 3

$$SF = I_{sc} / I_{DG}$$

SF is a function of system short-circuit-current at the point of connection to the current from the DG. Typically this equation is used when evaluating a single DG of any form connecting to the power system. In the case of Hawaiian Electric Company one of the things that need to be evaluated is the potential of flicker on the 46 kV system when the 12 kV breaker opens. In this case I_{DG} becomes the current that is flowing in reverse through the 12 kV breaker. In order for there to be current flowing in reverse then there must be more total solar generation than there is load on the circuit. In other words there must be greater than 100% penetration based on DML. In any case (2) was used to evaluate a 12 kV transformer connected at 20 miles of 46 kV line. The amount of reverse flow through the transformer can be 1700 kW and still maintain a SF of 50.

The 12 kV Equation 2 is used to evaluate the 100 kW back-feed of solar generation. The amount of solar connected at 19 Mi of 46 kV and 15 mi of 12 kV gave a result of >200 kW which indicates that the SF of 100 kW Solar is well within acceptable levels.

Based on these calculations it is believed that SF is not an issue for 100 kW at under 100% penetration from a flicker perspective.

 Hawaiian Electric	<i>H47-2 Representative High-Penetration Photo-Voltaic Circuit Study</i>
--	--

Appendix F – Voltage Rise

Voltage rise is a term that that may be more misleading than it may seem on the surface. A typical utility circuit has both Real Power loads and Reactive power Loads. These loads are the reason for the current flow through the feeder wire. As it happens the resistance of the wire is also a small load. As current flows through the wire there is Real and Reactive power consumed by the wire itself. This is one of the sources for loss in the power system. The power consumed by the wire gives rise to a voltage drop along the feeder. Longer wire leads to more the loss and greater the voltage drop. Greater amounts of current flowing in the wire lead to more loss and greater the voltage drop. Therefore, circuits that have more loads on them have greater current flowing and therefore more losses and greater voltage drop. At least this has been the case in traditionally structured utility power delivery systems where the power has traditionally flowed from the station to the customer.

On the other hand many Hawaiian Electric Company circuits have widely distributed generation along the feeder in cases with the HPPV. In this distributed generation scenario the current flow can be more local at times of high solar production such as noon on a sunny day. In these cases, the current flows immediately from the PV to the local load thereby reducing the overall current flow on the feeder wire. More specifically, the Real Power generated by the PV flows from the PV directly to the customer load at the same location. Therefore, at times of high PV production such as noon on a sunny day there is a reduction of Real Power flow on the feeder wires. However, small roof-top solar at this point in time does not produce Reactive Power. This can be done with commercial sized inverters and will likely happen on smaller inverters in the future, but today small inverters do not yet produce vars. Therefore, the Reactive power needed by the customers and the power grid still have to come from the utility. The Reactive power continues to flow along the same wires that it always has.

Reactive power flows from the utility to the customer regardless of the presence or absence of solar. The voltage drop from reactive power flow still needs to be managed regardless of PV. With all of this in mind the total Apparent Power flow from the substation at times of high PV production is reduced. The Real Power component of the customer and system need is served locally by the PV while the Reactive Power component of the customer and system need is served by the utility. As solar production increases from zero, the Real Power served by the utility decreases thereby reducing the overall flow of current on the feeder wire thereby reducing the overall voltage drop. This reduction in voltage drop will continue until all of the real power demands on the circuit are served by the local PV. This is at or around 100% penetration. Bear in mind that the reactive power is still served by the utility and will continue to lead to some small amount of voltage drop. At or around 100% penetration the feeder will have a minimum level of voltage drop and a minimum amount of losses. At his point the voltage regulating devise, the LTC in HECO’s case, will move closer to the neutral tap position. At 100% feeder penetration the LTC tap position will primarily influenced by the load and or generation on the adjacent

 UC SYNERGETIC <i>Innovative Thinking. Engineered Solutions.</i>	Filename: H47-2_Final.Docx Modified: 2/25/14 Page: 110 of 113
---	---

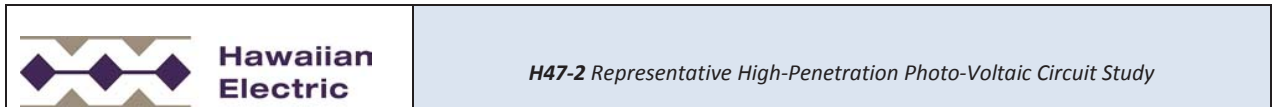

circuits and the voltage on the high side of the voltage regulator. With no losses and no voltage drop there is no work for the LTC to do.

Once total circuit penetration exceeds 100% penetration then the excess Real Power produced by the PV will flow back into the power system onto the feeder wires giving rise to a voltage drop in the opposite direction. However, the feeder voltage is regulated by the LTC at the substation. The PV does not currently regulate voltage. The PV sets it's voltage to what the local feeder voltage is. In this situation, the PV is listening to the line for voltage cues. The line voltage profile is quite flat and is being controlled by the LTC. This is where the adjacent feeder comes into the picture. The substation transformer is a high impedance path for the power to flow. The least impedance path the power produced by the PV is the adjacent feeder. If there is more load than generation on the adjacent feeder then the power will flow onto the adjacent feeder.

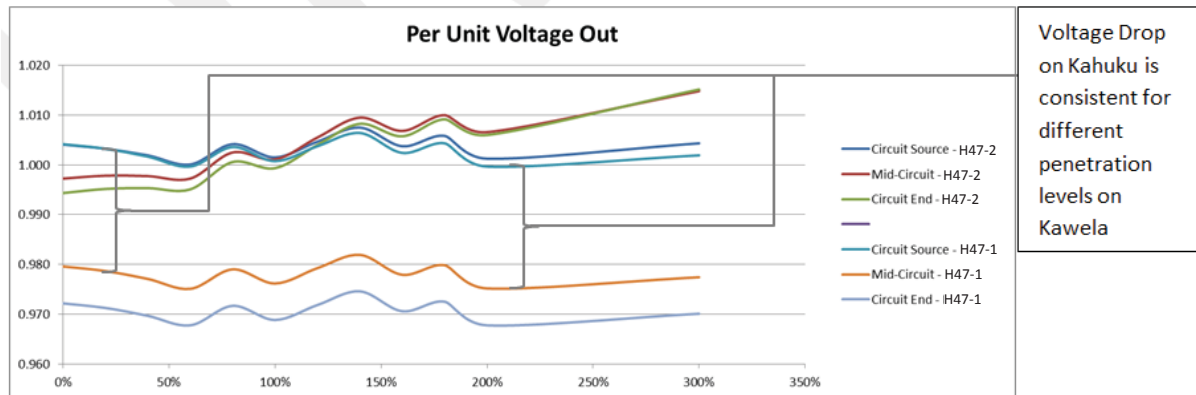
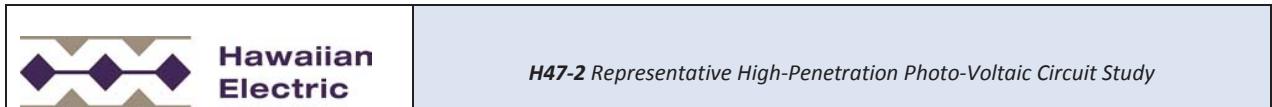

Figure 52 Voltage Performance vs. Penetration Level

The voltage profile on the adjacent feeder does not change if the loading or generation on the adjacent feeder does not change. Figure 52 Voltage Performance vs. Penetration Level Shows how the voltage drop from the Circuit Source to the Mid-Circuit or to the Circuit end is consistent at all penetration levels of PV on H47-2.

	Percent Voltage Drop to Mid-Circuit and Circuit End for Various Penetration Levels of PV on Kawela											
	0%	20%	40%	60%	80%	100%	120%	140%	160%	180%	200%	300%
Mid-Circuit - H47-2	-0.68%	-0.54%	-0.41%	-0.28%	-0.16%	-0.04%	0.08%	0.19%	0.30%	0.40%	0.51%	1.01%
Circuit End - H47-2	-0.97%	-0.80%	-0.65%	-0.49%	-0.35%	-0.21%	-0.06%	0.07%	0.19%	0.32%	0.46%	1.04%
Mid-Circuit - H47-1	-2%	-2%	-2%	-2%	-2%	-2%	-2%	-2%	-2%	-2%	-2%	-2%
Circuit End - H47-1	-3%	-3%	-3%	-3%	-3%	-3%	-3%	-3%	-3%	-3%	-3%	-3%

Table 37 Voltage Drop in Relationship to Penetration Level on H47-2



In the case of the H47-2 circuit, the voltage goes from a voltage drop to a voltage rise at the mid-circuit and end of circuit locations. The transition from lower voltage readings along line sections to higher voltage readings along line sections when compared to the substation or circuit source section happen at penetration levels above 100%. In reality this happens when the total Apparent Power flow changes on the backbone of the circuit from a forward flow direction to a reverse flow direction. In the case of H47-2 this happens at around 130% PV penetration. Keep in mind that PV creates real power and the total flow on the lines Real Power and Reactive Power, the combination of which is Apparent Power.

What the numbers in Table 37 Voltage Drop in Relationship to Penetration Level on show is that what is in fact happening is that there is still a voltage drop. However, the direction of the voltage drop has reversed. In traditional utility configurations the voltage drop is minimal at the station and most extreme at the end of the line. In the case of extremely HPPV the minimal voltage drop is at the end of the line and most extreme at the station. This is due to the direction of the current flow. However, the voltage reference has not changed. The voltage reference is still the substation LTC. In traditional utility configurations the voltage reference is located at the same place as the minimal voltage drop, that being at the substation. In the extremely HPPV case the voltage reference is located at the same place as the maximum voltage drop, that being at the substation. The results are in increased voltage readings at the end of the line in the presence of extremely HPPV. What is typically portrayed as a voltage rise is actually a reverse voltage drop. The distinction is subtle, but important in understanding the behavior of circuits in the presence of extremely HPPV.

What this ultimately means is that there are multiple regimes of penetration that need to be monitored in order to understand what to do in cases of high and extremely HPPV. These regimes include:

- <100% Feeder Penetration
 - PV replaces the Real Power otherwise supplied by the utility thereby reducing load flow on the feeder backbone. At less than 100% penetration PV serves to reduce losses and reduce voltage drop along the feeder.
- 100% Feeder PV Penetration (kW)
 - Represents when losses on the EHPPV Circuit are minimal
 - Represents the threshold when Real Power will begin to feed from the EHPPV Circuit to the adjacent circuits served by the same transformer
- 100% Feeder Apparent Power Penetration (kVA)
 - Represents when total Apparent Power reverses direction on the feeder
 - If the circuit is fed from a voltage regulator, then this is the point at which flow will reverse through the voltage regulator.
 - This is the point at which the control mode of the voltage regulator must be switched to bi-directional or co-generation mode (preferably co-generation mode).

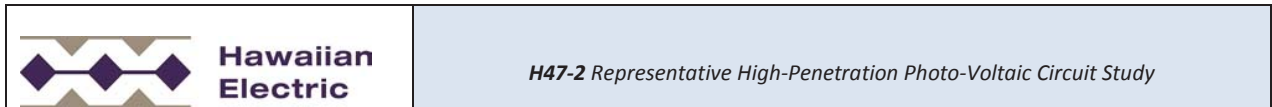

- 100% Station PV Penetration (kW)
 - Represents when losses on the EHPPV Circuit are minimal
 - Represents the threshold when Real Power will begin to feed from the EHPPV Circuit to the sub-transmission system
- 100% Station Apparent Power Penetration (kVA)
 - Represents when total Apparent Power reverses direction on the LTC and/or Substation Transformer
 - If the substation is fed from a LTC, then this is the point at which flow will reverse through the LTC.
 - This is the point at which the control mode of voltage regulator must be switched to bi-directional or co-generation mode (preferably co-generation mode).

F. Data, Models, and Criteria

Modeling efforts are heavily dependent on the quality of the model and the details represented in the model. This appendix describes the various types of input data required for the studies and the application of the data in the modeling analysis.

FEEDER MODEL

The feeder model is the geographical layout of the system, the equipment specifications and the connected load on the circuits. This is extracted by the Companies from their respective GIS software, and delivered in two databases – one for distribution feeders and one for sub-transmission feeders. The user then extracts the sub-transmission and distribution feeder components required for each study from the larger datasets. After the feeder model is extracted, data checks are required to determine that the analysis runs satisfactorily

LOAD DATA

Load profiles are required for the maximum daytime peak and minimum daytime load days. These are days with high PV generation and either minimum or maximum load between the hours of 10am and 2pm. These day profiles form the boundary conditions of the analysis, and it is assumed that the other days fall within these two conditions. Several criteria are observed in the selection of the peak and minimum load days profiles.

The values measured by utility Supervisory Control And Acquisition Data (SCADA) and field monitoring equipment are the customer demand measured at the transformer, or at a circuit breaker in the substation. Not every distribution feeder is directly or individually measured. For some of the feeders with no monitored data, an estimate of the load on these feeders can be made by taking the summation of the feeder demand served at the 46kV level (which is monitored by SCADA) and subtracting any known feeder demand on the 46kV line, estimating the remaining demand on the feeders without measurement. This remaining demand is allocated to the remaining feeders in proportion to their historical peak load values.

Peak loads are determined for each circuit on an annual basis by the utility and are derived from the SCADA data where available. For circuits without any SCADA information, temporary monitors are sometimes used to collect the load data for a short period of time to periodically assess conditions. This includes the effect of PV or other generation on the system and does not represent the true “gross” load value.

To get from this “net” value to the “gross” load, the approximate PV generation profile is estimated based on sensor data or from irradiance data. The PV generation profile is added to the “net” load profile to get the “gross” load on the system, as shown in **Figure 3.2** below.

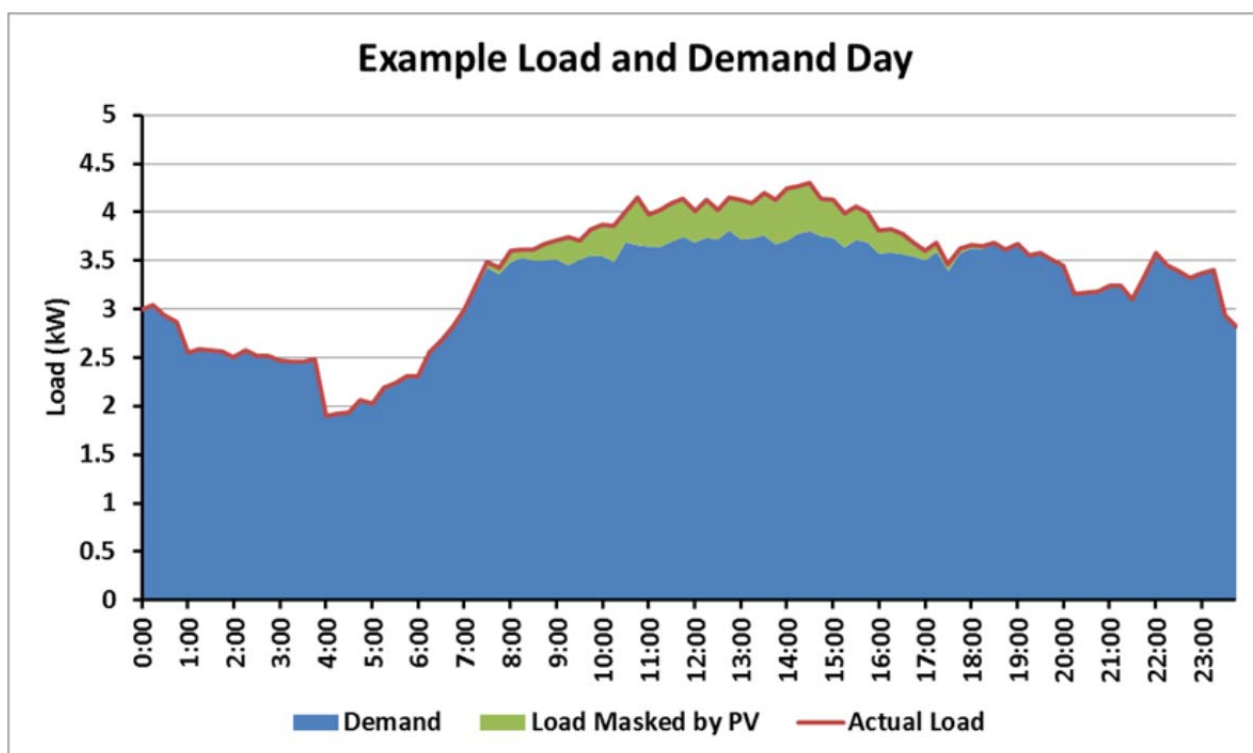

Figure E.1: Example Load and Demand Day

In this chart, the blue area represents the ‘demand’, which is the load measured at the substation. The green area represents the estimated PV generation profile on the feeder for the day in question, which masks some of the actual load used by the customers. The red line represents the actual load used by the customers connected to the circuit, obtained by adding the masked load to the demand measured at the substation.

PV MODELING

As part of the Proactive Approach, modeling distributed resources as generators versus negative load is one of the biggest changes to traditional modeling. This enables future smarter functionality to be incorporated to help manage variability due to renewables; however, it also helps improve system reliability and provides cost savings by accounting for behind the meter generation. Hawaiian Electric Companies have enabled a REWatch capability to “see” behind the meter generation, and with a proactive modeling capability, can begin to more timely and effectively “manage” the higher penetrations of variable behind the meter generation.

For each NEM, FIT, or SIA interconnection, the following information should be gathered for accurate modeling:

- ▲ Size
- ▲ Location
- ▲ Additional equipment specifications such as a grounding transformer bank
- ▲ Project specific transformer information

For transient analysis of NEMs, inverter modeling and data requirements are more challenging. To study load rejection over voltage, study tools need to be capable of adequately capturing the electromagnetic transients in a power system. Further, the inverter models also

need to have the same capability. The biggest challenge is the lack of industry accepted PSCAD models for single phase inverters. The existing inverters on the system are from different manufacturers with different technology. For the penetration studies, generic models were created based on available information from single phase inverter manufacturers. Results obtained from both models were consistent and demonstrated that the over voltage magnitude increases as penetration level increase.

Three-phase transient analysis inverter models are typically available upon request from inverter manufacturers.

Remaining DG Capacity 150% DML

150% DML DG Capacity

551

SUBSTATION	CKT	Primary Voltage (kV)	Existing				Existing 50% Backbone				Existing DG to 100% Gross				2016 Short Term				2016 Feeder Level Remaining DG kW to 150% Gross DML
			Primary Min Load (kVA)	Existing Primary Load (kVA)	Existing Peak Load (kVA)	Existing Capacity (kVA)	Remaining 50% Backbone Feeder Rating (kW)	Existing Feeder Level Remaining DG kW to 100% Gross DML	Existing Feeder Level Remaining DG kW to 120% Gross DML	Existing Feeder Level Remaining DG kW to 150% Gross DML	Total DG kW on Primary - 2016 Term	2016 Primary Min Load (kVA)	2016 Primary Peak Load (kVA)	2016 Remaining Backbone Feeder Rating (kW)	2016 Remaining DG to 50% Backbone Feeder Rating (kW)				
Hawaiian Electric																			
TSF-H1	H1-1	12.47	1,350.3	969.6	2,424.0	4730	4349	-380.7	-186.8	104.1	1,520.6	994	2,486	4204	4326	246.6			
TSF-H1	H1-2	12.47	1,513.3	1,268.0	3,170.0	4730	4485	-245.3	8.3	388.7	1,704.1	1,300	3,251	4326	4089	215.7			
TSF-H2	H2-1	12.47	2,061.1	1,670.4	4,176.0	4730	4339	-390.7	-56.6	444.5	2,354.0	1,713	4,283	4089	6114	2411.8			
TSF-H2	H2-2	12.47	597.0	2,004.8	5,012.0	4730	6138	1407.8	1808.7	2410.2	672.3	2,056	5,140	6114	1200.9				
TSF-H3	H3-1	11.5	744.5	1,325.6	3,314.0	3794	4376	581.1	846.3	84.1	838.3	1,360	3,399	4316	1200.9				
TSF-H3	H3-2	11.5	1,334.3	945.6	2,364.0	3794	3406	-388.7	-199.6	84.1	1,640.3	970	2,424	3124	-185.6				
TSF-H4	H4-1	11.5	1,764.8	1,242.0	3,105.0	3794	3272	-522.8	-274.4	98.2	2,140.0	1,274	3,184	2928	-229.3				
TSF-H4	H4-2	11.5	276.7	1,638.0	4,095.0	3794	5156	1361.3	1688.9	2180.3	386.7	1,680	4,200	5088	2133.1				
TSF-H5	H5-1	11.5	367.7	908.4	2,271.0	3794	4335	540.7	722.4	994.9	166.3	235	588	4312	983.4				
TSF-H5	H5-2	11.5	60.7	229.2	573.0	3794	3963	168.5	214.3	283.1	671.7	703	1,757	1342	382.3				
TSF-H6	H6-1	4.16	596.5	685.2	1,713.0	1311	1400	88.7	225.7	431.3	1,104.7	1,540	3,851	6019	1205.9				
TSF-H7	H7-1	4.16	536.2	418.4	1,046.0	1311	1194	-117.8	-34.1	91.4	1,329.0	601	1,501	583	-10.8				
TSF-H8	H8-1	4.16	1,142.6	585.6	1,464.0	1311	754	-557.0	-439.9	-264.2	1,212.2	438	3,595	5809	944.6				
TSF-H9	H9-1	12.47	1,076.5	1,402.0	3,505.0	5583	5909	325.5	605.9	1026.5	1,104.7	1,540	3,851	6019	1205.9				
TSF-H9	H9-2	12.47	840.7	1,502.0	3,755.0	5583	6245	661.3	961.7	1412.3	296.5	249	623	1264	77.0				
TSF-H10	H10-1	4.16	263.3	242.8	607.0	1311	1291	-20.5	28.1	100.9	957.2	1,174	2,935	5216	803.9				
TSF-H11	H11-1	11.5	-	1,144.8	2,862.0	5000	6144	1,144.8	1,373.8	1717.2	281.5	1,811	4,527	6529	2434.6				
TSF-H12	H12-1	11.5	-	1,765.6	4,414.0	5000	6765	1,765.6	2,118.7	2648.4	281.5	1,811	4,527	6529	2434.6				
TSF-H13	H13-1	11.5	346.8	2,154.0	5,385.0	4213	6020	1807.2	2,238.0	2884.2	390.5	2,209	5,523	6031	2923.1				
TSF-H13	H13-2	11.5	-	1,686.0	4,215.0	4213	5899	1686.0	2023.2	2329.0	200.4	1,729	4,323	5741	2393.2				
TSF-H14	H14-1	12.47	2,437.6	1,895.6	4,739.0	5508	4966	-542.0	-162.9	405.8	2,744.9	1,944	4,860	4707	171.2				
TSF-H15	H15-1	12.47	1,278.0	1,791.6	4,479.0	5421	5935	513.6	871.9	1409.4	1,439.2	1,837	4,594	5820	1317.0				
TSF-H15	H15-2	12.47	145.2	308.8	772.0	5421	5585	163.6	225.3	318.0	292.2	317	792	5446	182.9				
TSF-H16	H16-1	12.47	-	1,353.2	3,383.0	3456	4809	1353.2	1,623.8	2029.8	173.4	1,388	3,470	4670	1908.3				
TSF-H17	H17-1	12.47	-	1,112.0	2,780.0	3456	4568	1112.0	1,334.4	1,668.0	6.8	1,140	2,851	4589	1703.9				
TSF-H18	H18-1	12.47	1,339.8	1,698.4	4,246.0	4730	5089	358.6	698.3	1,207.8	1,747.8	1,742	4,355	4724	865.0				
TSF-H18	H18-2	12.47	1,195.2	1,072.8	2,682.0	4730	4608	-122.4	92.2	414.0	1,398.0	1,100	2,751	4432	252.4				
TSF-H19	H19-1	12.47	1,222.7	1,078.0	2,695.0	4730	4585	-144.7	70.9	394.3	1,597.1	1,106	2,764	4239	61.2				
TSF-H19	H19-2	12.47	2,003.5	1,772.0	4,430.0	4730	4499	-231.5	122.9	654.5	2,418.8	1,817	4,543	4129	307.2				
TSF-H20	H20-1	12.47	1,201.5	1,436.0	3,590.0	4266	4500	234.5	521.7	952.5	1,353.0	1,473	3,682	4386	856.1				
TSF-H21	H21-1	12.47	2,124.9	1,836.0	4,590.0	5421	5132	-288.9	78.3	629.1	2,392.8	1,883	4,707	4911	431.7				
TSF-H22	H22-1	11.5	4.7	874.8	2,187.0	3536	4406	870.1	1045.1	1307.5	5.3	897	2,243	4427	1340.5				
TSF-H22	H22-2	11.5	159.0	2,128.8	5,322.0	3536	4495	1969.8	2395.6	3034.2	275.8	2,183	5,458	5443	2999.1				
TSF-H23	H23-1	11.5	217.6	1,177.2	2,943.0	3536	4495	959.6	1195.0	1548.2	245.0	1,207	3,018	4498	1565.9				
TSF-H23	H23-2	11.5	242.0	836.8	2,092.0	3536	4130	594.8	762.1	1013.2	272.5	858	2,146	4121	1014.8				

551

SUBSTATION	CKT	Primary Voltage (kV)	2020Short Term					2030 Long Term				
			Total DG kW on Primary - 2020 Mid Term	2020 Primary Min Load (kVA)	2020 Primary Peak Load (kVA)	Remaining DG to 50% Backbone Feeder Rating (kW)	2020 Feeder Level Remaining DG kW to 150% Gross DML	Total DG kW on Primary - 2030 Long Term	2030 Primary Min Load (kVA)	2030 Primary Peak Load (kVA)	Remaining DG to 50% Backbone Feeder Rating (kW)	2030 Feeder Level Remaining DG kW to 150% Gross DML
Hawaiian Electric												
TSF-H1	H1-1	12.47	1,974.8	1,023	2,558	3779	-439.8	2,845.8	771	1,927	2655	-1689.7
TSF-H1	H1-2	12.47	2,213.1	1,338	3,346	3855	-205.7	3,189.3	1,008	2,520	2549	-1677.4
TSF-H2	H2-1	12.47	3,057.1	1,763	4,407	3436	-412.7	4,405.5	1,328	3,319	1652	-2413.9
TSF-H2	H2-2	12.47	873.1	2,116	5,290	5973	2300.7	1,258.2	1,594	3,984	5065	1132.2
TSF-H3	H3-1	11.5	1,088.7	1,399	3,498	4105	1009.8	1,569.0	1,054	2,634	3279	11.6
TSF-H3	H3-2	11.5	2,130.2	998	2,495	2662	-633.2	3,069.8	752	1,879	1476	-1942.4
TSF-H4	H4-1	11.5	2,779.2	1,311	3,277	2326	-812.9	4,005.0	987	2,468	777	-2524.1
TSF-H4	H4-2	11.5	502.2	1,729	4,322	5021	2090.9	723.8	1,302	3,255	4373	1229.3
TSF-H5	H5-1	11.5	537.7	959	2,397	4216	900.4	774.8	722	1,805	3742	308.3
TSF-H5	H5-2	11.5	216.0	242	605	3820	146.9	311.2	182	455	3665	-37.9
TSF-H6	H6-1	4.16	872.4	723	1,808	1162	212.4	1,257.2	545	1,362	599	440.2
TSF-H7	H7-1	4.16	849.9	442	1,104	903	-187.6	1,224.8	333	831	419	-726.0
TSF-H8	H8-1	4.16	1,726.0	618	1,545	203	-798.9	2,487.2	465	1,164	-710	-1789.0
TSF-H9	H9-1	12.47	1,574.3	1,480	3,699	5489	645.3	2,268.7	1,114	2,786	4429	-597.0
TSF-H9	H9-2	12.47	1,434.7	1,585	3,963	5734	943.1	2,067.5	1,194	2,985	4710	-276.6
TSF-H10	H10-1	4.16	385.1	256	641	1183	-0.7	554.9	193	482	949	-265.4
TSF-H11	H11-1	11.5	1,243.1	1,208	3,021	4965	569.3	1,791.4	910	2,275	4118	-426.4
TSF-H12	H12-1	11.5	365.6	1,863	4,659	6497	2429.5	526.9	1,403	3,509	5876	1578.3
TSF-H13	H13-1	11.5	507.2	2,273	5,683	5979	2902.8	730.9	1,712	4,280	5194	1837.4
TSF-H13	H13-2	11.5	260.3	1,779	4,449	5732	2408.8	375.1	1,340	3,350	5178	1635.1
TSF-H14	H14-1	12.47	3,564.9	2,001	5,002	3943	-563.9	5,137.3	1,507	3,767	1877	-2877.1
TSF-H15	H15-1	12.47	1,869.1	1,891	4,727	5443	967.2	2,693.5	1,424	3,560	4152	-557.3
TSF-H15	H15-2	12.47	379.4	326	815	5368	109.4	546.8	245	614	5120	-178.6
TSF-H16	H16-1	12.47	225.2	1,428	3,570	4659	1917.1	324.6	1,076	2,689	4207	1288.9
TSF-H17	H17-1	12.47	8.8	1,174	2,934	4621	1751.7	12.6	884	2,210	4327	1313.2
TSF-H18	H18-1	12.47	2,269.9	1,793	4,481	4253	418.9	3,271.0	1,350	3,375	2809	-1246.0
TSF-H18	H18-2	12.47	1,815.6	1,132	2,831	4047	-117.2	2,616.4	853	2,132	2966	-1337.3
TSF-H19	H19-1	12.47	2,074.2	1,138	2,844	3794	-367.6	2,989.1	857	2,142	2598	-1703.8
TSF-H19	H19-2	12.47	3,141.3	1,870	4,675	3459	-336.0	4,526.8	1,409	3,521	1612	-2414.0
TSF-H20	H20-1	12.47	1,757.1	1,516	3,789	4024	516.3	2,532.1	1,141	2,854	2875	-819.9
TSF-H21	H21-1	12.47	3,107.5	1,938	4,844	4251	-2009.9	4,478.2	1,459	3,649	2403	-2289.1
TSF-H22	H22-1	11.5	6.8	923	2,308	4452	1378.1	9.8	695	1,738	4221	1033.2
TSF-H22	H22-2	11.5	358.2	2,247	5,617	5424	3012.0	516.1	1,692	4,230	4712	2022.1
TSF-H23	H23-1	11.5	318.2	1,242	3,106	4460	1545.4	458.6	936	2,339	4013	945.0
TSF-H23	H23-2	11.5	354.0	883	2,208	4065	970.8	510.1	665	1,663	3691	487.7

SUBSTATION	CKT	Primary Voltage (kV)	Existing										2016 Short									
			Total DG (kW) on Primary - 2014	Existing Primary Load (kW)	Existing Primary Min Load (kW)	Existing Primary Peak Load (kW)	Existing 50% Backbone Capacity (kVA)	Existing 50% Backbone Feeder Rating (kW)	Existing DG to 50% Backbone Feeder Rating (kW)	Existing Feeder Level Remaining DG kW to 100% Gross DML	Existing Feeder Level Remaining DG kW to 120% Gross DML	Existing Feeder Level Remaining DG kW to 150% Gross DML	Total DG kW on Primary - 2016 Short Term	2016 Primary Min Load (kVA)	2016 Primary Peak Load (kVA)	Remaining DG to 50% Backbone Feeder Rating (kW)	2016 Short Term Remaining DG to 150% Gross DML					
TSF-H24	H24-1	4.16	468.8	587.2	1,468.0	1020	1138	118.4	235.8	412.0	527.9	602	1,506	1094	375.4							
TSF-H24	H24-2	4.16	335.0	326.0	815.0	1020	1011	-9.0	56.2	154.0	377.3	334	836	977	124.2							
TSF-H25	H25-1	12.47	1,389.1	1,264.8	3,162.0	4266	4141	-124.3	128.7	508.1	1,705.8	1,297	3,243	3857	239.9							
TSF-H25	H25-2	12.47	1,780.7	1,387.6	3,469.0	4266	3873	-393.1	-115.6	300.7	2,120.6	1,423	3,558	3568	14.0							
TSF-H26	H26-1	12.47	1,797.3	1,095.2	2,738.0	4266	3564	-702.1	-483.1	-154.5	2,084.2	1,123	2,808	3305	-399.4							
TSF-H26	H26-2	12.47	1,014.2	1,064.8	2,662.0	4266	4316	50.6	263.6	583.0	1,142.1	1,092	2,730	4216	496.0							
TSF-H27	H27-1	11.5	1,054.0	1,091.2	2,728.0	4362	4399	37.2	255.4	582.8	1,186.9	1,119	2,798	4294	491.7							
TSF-H27	H27-2	11.5	1,207.8	1,522.8	3,807.0	4862	4677	315.0	619.5	1076.4	1,360.1	1,562	3,904	4564	982.5							
TSF-H28	H28-1	11.5	1,034.4	1,527.6	3,819.0	4213	4706	493.2	798.7	1257.0	1,356.1	1,567	3,917	4423	993.9							
TSF-H28	H28-2	11.5	918.5	1,430.0	3,575.0	4213	4724	511.5	797.5	1226.5	1,034.3	1,467	3,666	4645	1165.5							
TSF-H29	H29-1	4.16	10.4	230.4	576.0	793	1013	220.0	266.1	335.2	11.7	236	591	1017	342.7							
TSF-H30	H30-1	11.5	436.9	2,223.6	5,559.0	4780	6567	1786.7	2231.4	2898.5	685.8	2,280	5,701	6375	2734.9							
TSF-H30	H30-2	11.5	647.3	1,594.0	3,985.0	5129	6076	946.7	1265.5	1743.7	1,089.0	1,635	4,087	5675	1363.1							
TSF-H31	H31-1	12.47	688.5	1,269.6	3,174.0	5421	6022	601.1	855.0	1235.9	752.8	1,302	3,255	5971	1200.3							
TSF-H32	H32-1	12.47	29.7	66.4	166.0	5421	5458	36.7	50.0	69.9	33.4	68	170	5456	68.7							
TSF-H33	H33-1	11.5	446.5	829.6	2,074.0	4362	4745	383.1	549.0	797.9	502.8	851	2,127	4710	773.4							
TSF-H33	H33-2	11.5	1,758.9	1,426.4	3,566.0	4862	4030	-332.5	-47.2	380.7	1,980.6	1,463	3,657	3844	213.7							
TSF-H34	H34-1	11.5	683.5	1,562.4	3,906.0	4362	5241	878.9	1191.3	1660.1	774.8	1,602	4,006	5190	1628.7							
TSF-H34	H34-2	11.5	-	1,328.0	3,320.0	4362	5690	1328.0	1593.6	1992.0	-	1,362	3,405	5724	2042.9							
TSF-H35	H35-1	11.5	903.8	2,023.6	5,059.0	4213	5333	1119.8	1524.6	2131.6	1,017.7	2,075	5,188	5270	2095.3							
TSF-H36	H36-1	12.47	1,259.1	1,674.4	4,186.0	4320	4735	415.3	750.2	1252.5	1,460.4	1,717	4,293	4577	1115.4							
TSF-H36	H36-2	12.47	903.2	1,502.4	3,756.0	4320	4919	599.2	899.7	1350.4	1,017.1	1,541	3,852	4843	1294.2							
TSF-H37	H37-1	12.47	255.4	376.0	940.0	4320	4440	120.6	195.8	308.6	600.5	386	964	4105	-22.1							
TSF-H37	H37-2	12.47	253.4	1,002.4	2,506.0	4320	5069	749.0	949.4	1250.2	285.4	1,028	2,570	5062	1256.7							
TSF-H38	H38-1	11.5	411.9	2,270.0	5,675.0	4780	6639	1858.1	2312.1	2993.1	463.9	2,328	5,820	6645	3028.2							
TSF-H39	H39-1	11.5	1,254.8	2,013.6	5,034.0	5000	5758	758.8	1161.6	1765.6	1,413.0	2,065	5,163	5652	1684.7							
TSF-H39	H39-2	11.5	147.8	277.2	693.0	4581	4711	129.4	184.9	268.0	234.1	284	711	4631	192.3							
TSF-H40	H40-1	11.5	835.9	1,860.8	4,652.0	4581	5606	1024.9	1397.1	1955.3	941.3	1,908	4,771	5548	1921.3							
TSF-H40	H40-2	11.5	203.2	1,963.2	4,908.0	4780	6540	1760.0	2152.6	2741.6	228.9	2,013	5,034	6565	2791.2							
TSF-H41	H41-1	24.94	312.8	582.4	1,456.0	8488	8758	269.6	386.0	560.8	352.3	597	1,493	8733	543.7							
TSF-H42	H42-1	12.47	1,142.2	1,640.0	4,100.0	5108	5606	497.8	825.8	1317.8	1,391.1	1,682	4,205	5399	1131.8							
TSF-H43	H43-1	4.16	426.1	253.2	633.0	1041	868	-172.9	-122.3	-46.3	479.8	260	649	821	-90.3							
TSF-H43	H43-2	4.16	506.3	426.8	1,067.0	1020	940	-79.5	5.8	133.9	570.2	438	1,094	887	86.4							
TSF-H43	H43-3	4.16	840.7	626.8	1,567.0	1020	1020	-213.9	-88.5	99.5	1,011.8	643	1,607	651	-47.6							
TSF-H44	H44-1	12.47	621.3	343.2	858.0	4903	4625	-278.1	-209.5	-106.5	708.6	352	880	4546	-180.6							
TSF-H44	H44-2	12.47	1,527.1	2,216.8	5,542.0	4903	5593	689.7	1133.1	1798.1	1,719.6	2,273	5,684	5457	1690.6							
TSF-H45	H45-1	4.16	666.2	428.8	1,072.0	1020	782	-237.4	-151.6	-23.0	750.2	440	1,099	709	-90.5							
TSF-H45	H45-2	4.16	475.0	381.6	954.0	1020	926	-93.4	-17.1	97.4	556.2	391	978	855	30.8							
TSF-H45	H45-3	4.16	491.6	268.0	670.0	1041	818	-223.6	-170.0	-89.6	720.8	2121	5,303	6962	-141.3							
TSF-H46	H46-1	12.47	493.2	2,068.4	5,171.0	5562	7137	1575.2	1988.9	2609.4	1,807.3	1,566	3,916	5321	5421.1							
TSF-H46	H46-2	12.47	1,437.9	1,527.2	3,818.0	5562	5651	89.3	394.8	852.9	1,807.3	1,566	3,916	5321	5421.1							

SUBSTATION	CKT	Primary Voltage (kV)	2020 Short Term				2020 Feeder Level				2030 Long Term			
			Total DG kW on Primary - 2020 Mid Term	2020 Primary Min Load (kVA)	2020 Primary Peak Load (kVA)	Remaining DG to 50% Backbone Feeder Rating (kW)	Total DG kW on Primary - 2020 Mid Term	2020 Primary Min Load (kVA)	2020 Primary Peak Load (kVA)	Remaining DG to 50% Backbone Feeder Rating (kW)	Total DG kW on Primary - 2030 Long Term	2030 Primary Min Load (kVA)	2030 Primary Peak Load (kVA)	Remaining DG to 50% Backbone Feeder Rating (kW)
TSF-H24	H24-1	4.16	685.6	620	1,549	954	244.0	988.0	467	1,167	498	-287.9		
TSF-H24	H24-2	4.16	490.0	344	860	874	26.1	706.1	259	648	573	-317.4		
TSF-H25	H25-1	12.47	2,215.4	1,335	3,337	3385	-213.0	3,192.5	1,005	2,513	2079	-1684.5		
TSF-H25	H25-2	12.47	2,754.0	1,464	3,661	2976	-557.3	3,968.7	1,103	2,757	1400	-2314.3		
TSF-H26	H26-1	12.47	2,706.8	1,156	2,890	2715	-973.0	3,900.7	871	2,176	1236	-2594.9		
TSF-H26	H26-2	12.47	1,483.2	1,124	2,810	3906	202.5	2,137.4	867	2,116	2975	-867.8		
TSF-H27	H27-1	11.5	1,541.5	1,152	2,879	3972	186.0	2,221.4	867	2,168	3008	-920.3		
TSF-H27	H27-2	11.5	1,766.4	1,607	4,018	4203	644.4	2,545.5	1,210	3,026	3027	-729.8		
TSF-H28	H28-1	11.5	1,761.1	1,612	4,031	4064	657.2	2,537.9	1,214	3,036	2889	-716.5		
TSF-H28	H28-2	11.5	1,343.3	1,509	3,773	4379	920.6	1,935.8	1,137	2,842	3414	-230.8		
TSF-H29	H29-1	4.16	15.2	243	608	1021	349.5	21.9	183	458	954	252.8		
TSF-H30	H30-1	11.5	890.6	2,347	5,867	6237	2629.6	1,283.5	1,768	4,419	5264	1367.8		
TSF-H30	H30-2	11.5	1,414.3	1,682	4,206	5397	1109.2	2,038.1	1,267	3,168	4358	-137.5		
TSF-H31	H31-1	12.47	977.7	1,340	3,350	5784	1032.3	1,408.9	1,009	2,523	5022	104.9		
TSF-H32	H32-1	12.47	43.4	70	175	5448	61.7	62.6	53	132	5411	16.6		
TSF-H33	H33-1	11.5	653.0	876	2,189	4585	660.3	941.1	659	1,649	4081	48.1		
TSF-H33	H33-2	11.5	2,572.2	1,505	3,764	3295	-314.1	3,706.8	1,134	2,835	1789	-2006.1		
TSF-H34	H34-1	11.5	1,006.3	1,649	4,122	5005	1467.2	1,450.1	1,242	3,105	4154	412.8		
TSF-H34	H34-2	11.5	-	1,402	3,504	5764	2102.4	-	1,056	2,639	5418	1583.4		
TSF-H35	H35-1	11.5	1,321.7	2,136	5,339	5027	1881.9	1,904.7	1,609	4,021	3917	508.1		
TSF-H36	H36-1	12.47	1,896.7	1,767	4,418	4190	754.1	2,733.2	1,331	3,327	2917	-736.8		
TSF-H36	H36-2	12.47	1,320.9	1,586	3,964	4585	1057.6	1,903.5	1,194	2,986	3610	-112.1		
TSF-H37	H37-1	12.47	779.9	397	992	3937	-184.6	1,123.9	299	747	3495	-675.6		
TSF-H37	H37-2	12.47	370.6	1,058	2,645	5007	1216.3	534.1	797	1,992	4582	661.1		
TSF-H38	H38-1	11.5	602.4	2,396	5,989	6574	2991.2	868.2	1,804	4,511	5717	1838.4		
TSF-H39	H39-1	11.5	1,835.0	2,125	5,313	5290	1352.7	2,644.4	1,601	4,001	3956	-243.6		
TSF-H39	H39-2	11.5	304.0	293	731	4570	134.8	438.1	220	551	4363	-107.6		
TSF-H40	H40-1	11.5	1,222.4	1,964	4,910	5323	1723.4	1,761.6	1,479	3,698	4299	457.1		
TSF-H40	H40-2	11.5	297.2	2,072	5,180	6555	2810.7	428.3	1,561	3,901	5913	1912.4		
TSF-H41	H41-1	24.94	457.5	615	1,537	8645	464.5	659.3	463	1,157	8292	35.1		
TSF-H42	H42-1	12.47	1,806.7	1,731	4,327	5032	789.7	2,603.5	1,304	3,259	3808	-648.1		
TSF-H43	H43-1	4.16	623.2	267	668	685	-222.3	898.0	201	503	344	-596.1		
TSF-H43	H43-2	4.16	740.5	450	1,126	730	-64.8	1,067.1	339	848	292	-558.2		
TSF-H43	H43-3	4.16	1,314.1	662	1,654	367	-321.8	1,893.7	498	1,246	-376	-1146.3		
TSF-H44	H44-1	12.47	920.2	362	906	4345	-376.9	1,326.1	273	682	3850	-916.9		
TSF-H44	H44-2	12.47	2,233.3	2,340	5,849	5009	1276.1	3,218.4	1,762	4,405	3447	-575.2		
TSF-H45	H45-1	4.16	974.3	453	1,131	498	-295.4	1,404.0	341	852	-44	-892.7		
TSF-H45	H45-2	4.16	722.4	403	1,007	700	-118.3	1,041.0	303	758	282	-586.0		
TSF-H45	H45-3	4.16	718.9	283	707	605	-294.7	1,036.1	213	533	218	-716.5		
TSF-H46	H46-1	12.47	986.1	2,183	5,458	6809	2338.4	1,349.0	1,644	4,110	5857	1117.2		
TSF-H46	H46-2	12.47	2,347.1	1,612	4,030	4826	70.6	3,382.4	1,214	3,035	3393	-1561.4		

SUBSTATION	CKT	Primary Voltage (kV)	Existing											2016 Short				
			Total DG (kW) on Primary - 2014	Existing Primary Load (kW)	Existing Primary Min Load (kW)	Existing Primary Peak Load (kW)	Existing 50% Backbone Capacity (kVA)	Existing 50% Backbone Feeder Rating (kW)	Existing Feeder Level Remaining DG kW to 100% Gross	Existing Feeder Level Remaining DG kW to 120% Gross	Existing Feeder Level Remaining DG kW to 150% Gross	Total DG kW on Primary - 2016 Short Term	2016 Primary Min Load (kVA)	2016 Primary Peak Load (kVA)	Remaining DG to 50% Backbone Feeder Rating (kW)	2016 Feeder Level Remaining DG kW to 150% Gross DML		
TSF-H47	H47-1	11.5	1,016.6	1,342.0	1,342.0	3,355.0	5129	5454	593.8	325.4	593.8	996.4	1,160.3	1,376	3,441	5345	5945	904.1
TSF-H47	H47-2	11.5	1,125.8	1,198.0	1,198.0	2,995.0	5000	5072	311.8	72.2	311.8	671.2	1,484.8	1,229	3,072	4743	4743	358.1
TSF-H48	H48-1	12.47	1,312.5	1,366.0	1,366.0	3,415.0	5562	5615	53.5	53.5	326.7	736.5	1,478.0	1,401	3,502	5485	5485	623.4
TSF-H48	H48-2	12.47	1,560.1	1,702.8	1,702.8	4,257.0	5562	5704	142.7	483.3	994.1	1,875.9	1,746	4,366	5432	5432	743.7	
TSF-H49	H49-1	4.16	515.4	489.6	489.6	1,224.0	1704	1678	25.8	72.1	219.0	613.4	502	1,255	1593	1593	139.8	
TSF-H50	H50-1	4.16	342.2	419.6	419.6	1,049.0	1099	1176	77.4	161.3	287.2	385.3	430	1,076	1144	1144	260.2	
TSF-H51	H51-1	4.16	549.8	319.2	319.2	798.0	1099	868	-230.6	-166.7	-71.0	630.5	327	818	796	796	-139.4	
TSF-H51	H51-2	4.16	249.3	198.8	198.8	497.0	793	742	50.5	-10.7	48.9	280.7	204	510	716	716	25.1	
TSF-H52	H52-1	4.16	146.3	92.4	92.4	231.0	1099	1045	53.9	-35.4	-7.7	274.5	95	237	919	919	-132.3	
TSF-H52	H52-2	4.16	412.7	341.6	341.6	854.0	1113	1042	-71.1	-2.8	99.7	464.7	350	876	999	999	60.8	
TSF-H52	H52-3	4.16	287.8	598.0	598.0	1,495.0	1113	1423	310.2	429.8	609.2	324.1	613	1,533	1402	1402	595.9	
TSF-H53	H53-1	11.5	10.2	742.8	742.8	1,857.0	3067	3800	732.6	881.2	1104.0	11.5	762	1,904	3818	3818	1131.2	
TSF-H53	H53-2	11.5	30.4	787.6	787.6	1,969.0	3067	3825	757.2	914.7	1151.0	34.2	808	2,019	3841	3841	1177.4	
TSF-H54	H54-1	11.5	8.1	261.6	261.6	654.0	3137	3391	253.5	305.8	384.3	9.1	268	671	3396	3396	393.3	
TSF-H55	H55-1	11.5	122.5	1,233.2	1,233.2	3,083.0	3067	4178	1110.7	1357.4	1727.3	137.9	1,265	3,162	4194	4194	1759.2	
TSF-H55	H55-2	11.5	230.5	2,079.6	2,079.6	5,199.0	3137	4986	1849.1	2265.1	2888.9	259.5	2,133	5,332	5010	2939.7	1730.4	
TSF-H55	H55-3	11.5	-	1,160.8	1,160.8	2,902.0	3137	4298	1160.8	1393.0	1741.2	55.3	1,190	2,976	4272	4272	1730.4	
TSF-H56	H56-1	12.47	307.0	573.2	573.2	1,433.0	2160	2426	266.2	380.8	552.8	345.7	588	1,470	2402	2402	536.1	
TSF-H57	H57-1	4.16	866.4	558.8	558.8	1,397.0	1117	809	-307.6	-195.9	-28.2	981.4	573	1,433	709	709	-121.8	
TSF-H57	H57-2	4.16	487.0	415.2	415.2	1,038.0	1311	1240	-71.8	11.2	135.8	579.5	426	1,065	1158	1158	59.2	
TSF-H58	H58-1	4.16	727.5	404.4	404.4	1,011.0	1117	794	-323.1	-242.3	-120.9	836.0	415	1,037	696	696	-213.8	
TSF-H59	H59-1	4.16	214.2	424.4	424.4	1,061.0	1117	1327	210.2	295.1	422.4	241.2	435	1,088	1311	1311	411.6	
TSF-H59	H59-2	4.16	140.8	236.4	236.4	591.0	1117	1212	95.6	142.8	213.8	278.3	242	606	1081	1081	85.3	
TSF-H60	H60-1	4.16	77.2	351.2	351.2	878.0	1117	1391	274.0	344.3	449.6	200.2	360	900	1277	1277	340.1	
TSF-H60	H60-2	4.16	237.7	535.2	535.2	1,338.0	1200	1497	297.5	404.5	565.1	650.7	549	1,372	1098	1098	172.7	
TSF-H61	H61-1	12.47	1,963.6	1,418.8	1,418.8	3,547.0	5562	5017	-544.8	-261.1	164.6	2,244.3	1,455	3,638	4772	4772	-611.6	
TSF-H61	H61-2	12.47	1,169.8	729.6	729.6	1,824.0	5562	5121	-440.2	-294.3	-75.4	1,480.2	748	1,871	4830	4830	-357.8	
TSF-H62	H62-1	4.16	349.7	400.0	400.0	1,000.0	1207	1257	50.3	130.3	250.3	441.2	410	1,026	1176	1176	174.2	
TSF-H62	H62-2	4.16	323.4	568.8	568.8	1,422.0	1207	1452	245.4	359.2	529.8	364.1	583	1,458	1426	1426	510.9	
TSF-H63	H63-1	4.16	417.1	707.6	707.6	1,769.0	1855	2146	290.5	432.0	644.3	492.9	726	1,814	2088	2088	595.6	
TSF-H64	H64-1	12.47	210.6	1,771.6	1,771.6	4,429.0	3477	5038	1561.0	1915.3	2446.8	341.6	1,817	4,542	4953	4953	2388.8	
TSF-H64	H64-2	12.47	1,140.4	759.2	759.2	1,898.0	3477	3096	-381.2	-229.4	-1.6	1,303.2	779	1,947	2953	2953	-135.3	
TSF-H65	H65-1	12.47	252.7	1,228.8	1,228.8	3,072.0	3477	4453	976.1	1221.8	1590.5	284.6	1,260	3,151	4453	4453	1605.7	
TSF-H65	H65-2	12.47	1,142.8	648.4	648.4	1,621.0	3477	2983	-494.4	-364.7	-170.2	1,416.1	665	1,662	2726	2726	-418.7	
TSF-H66	H66-1	12.47	1,271.5	664.0	664.0	1,660.0	3477	2870	-607.5	-474.7	-275.5	1,431.8	681	1,702	2727	2727	-410.3	
TSF-H66	H66-2	12.47	571.8	668.4	668.4	1,671.0	3477	3574	96.6	230.3	430.8	703.1	685	1,714	3460	3460	325.1	
TSF-H67	H67-1	24.94	445.8	1,916.6	1,916.6	4,904.0	12290	13805	1515.8	1908.1	2496.6	502.1	2,012	5,029	13799	13799	2515.6	
TSF-H67	H67-2	24.94	-	1,914.4	1,914.4	4,786.0	14204	14204	1914.4	2297.3	2871.6	168.9	1,963	4,908	14084	14084	2776.1	
TSF-H68	H68-1	12.47	1,905.5	2,087.2	2,087.2	5,218.0	4730	4912	181.7	599.1	1325.3	2,545.4	2,141	5,351	4325	4325	665.4	
TSF-H68	H68-2	12.47	907.8	842.8	842.8	2,107.0	4730	4665	-65.0	103.5	356.4	1,058.1	864	2,161	4536	4536	238.4	
TSF-H69	H69-1	12.47	1,589.4	1,803.2	1,803.2	4,508.0	4730	4944	213.8	574.5	1115.4	1,789.8	1,849	4,623	4790	4790	984.2	

SUBSTATION	CKT	Primary Voltage (kV)	2020 Short Term				2020 Feeder Level				2030 Long Term				2030 Feeder Level Remaining DG kW to 150% Gross DML
			Total DG kW on Primary - 2020 Mid Term	2020 Primary Min Load (kVA)	2020 Primary Peak Load (kVA)	Remaining DG to 50% Backbone Feeder Rating (kW)	Total DG kW on Primary - 2020 Mid Term	2020 Primary Min Load (kVA)	2020 Primary Peak Load (kVA)	Remaining DG to 50% Backbone Feeder Rating (kW)	Total DG kW on Primary - 2030 Long Term	2030 Primary Min Load (kVA)	2030 Primary Peak Load (kVA)	Remaining DG to 50% Backbone Feeder Rating (kW)	
TSF-H47	H47-1	11.5	1,506.9	1,416	3,541	5038	617.6			2,171.6	1,067	2,667	4024	-571.5	
TSF-H47	H47-2	11.5	1,928.4	1,264	3,161	4336	-31.8			2,778.9	952	2,381	3173	-1350.5	
TSF-H48	H48-1	12.47	1,919.5	1,442	3,604	5084	243.1			2,766.1	1,086	2,715	3881	-1137.4	
TSF-H48	H48-2	12.47	2,436.2	1,797	4,493	4923	259.5			3,510.8	1,354	3,384	3404	-1480.5	
TSF-H49	H49-1	4.16	796.6	517	1,292	1424	-21.5			1,148.0	389	973	945	-564.2	
TSF-H50	H50-1	4.16	500.4	443	1,107	1041	163.8			721.2	334	834	711	-220.9	
TSF-H51	H51-1	4.16	818.8	337	842	617	-313.5			1,180.0	254	634	173	-799.4	
TSF-H51	H51-2	4.16	364.5	210	525	638	-49.8			525.3	158	395	425	-288.3	
TSF-H52	H52-1	4.16	356.4	98	244	840	-210.2			513.7	73	184	659	-403.5	
TSF-H52	H52-2	4.16	603.5	361	901	870	-62.7			869.7	272	679	515	-462.4	
TSF-H52	H52-3	4.16	420.9	631	1,578	1323	525.8			606.5	475	1,188	982	106.5	
TSF-H53	H53-1	11.5	14.9	784	1,960	3837	1161.0			21.5	590	1,476	3636	864.2	
TSF-H53	H53-2	11.5	44.4	831	2,078	3854	1202.4			64.1	626	1,565	3629	875.0	
TSF-H54	H54-1	11.5	11.9	276	690	3401	402.3			17.1	208	520	3328	294.8	
TSF-H55	H55-1	11.5	179.1	1,302	3,254	4190	1773.2			258.1	980	2,451	3790	1212.3	
TSF-H55	H55-2	11.5	337.0	2,195	5,487	4995	2955.2			485.7	1,653	4,133	4305	1993.9	
TSF-H55	H55-3	11.5	71.8	1,225	3,063	4290	1765.9			103.5	923	2,307	3956	1280.5	
TSF-H56	H56-1	12.47	449.0	605	1,512	2316	458.5			647.0	456	1,139	1968	36.4	
TSF-H57	H57-1	4.16	1,274.6	590	1,474	432	-389.9			1,836.8	444	1,110	-276	-1170.5	
TSF-H57	H57-2	4.16	752.7	438	1,096	997	-95.3			1,084.6	330	825	557	-589.6	
TSF-H58	H58-1	4.16	1,085.7	427	1,067	458	-445.5			1,564.5	321	804	-126	-1082.4	
TSF-H59	H59-1	4.16	313.3	448	1,120	1251	358.6			451.5	337	843	1003	54.5	
TSF-H59	H59-2	4.16	361.5	249	624	1005	12.8			520.9	188	470	784	-239.0	
TSF-H60	H60-1	4.16	260.0	371	927	1228	296.0			374.7	279	698	1021	44.1	
TSF-H60	H60-2	4.16	845.0	565	1,412	920	2.3			1,217.7	425	1,064	407	-579.6	
TSF-H61	H61-1	12.47	2,914.7	1,497	3,744	4144	-688.5			4,200.2	1,128	2,819	2489	-2508.6	
TSF-H61	H61-2	12.47	1,922.3	770	1,925	4409	-767.3			2,770.2	580	1,450	3371	-1900.3	
TSF-H62	H62-1	4.16	572.9	422	1,055	1056	60.3			825.7	318	795	699	-348.7	
TSF-H62	H62-2	4.16	472.9	600	1,501	1334	427.6			681.5	452	1,130	978	-3.3	
TSF-H63	H63-1	4.16	640.1	747	1,867	1962	480.1			922.5	562	1,406	1495	-78.8	
TSF-H64	H64-1	12.47	443.6	1,870	4,674	4904	2361.1			639.2	1,408	3,521	4246	1473.1	
TSF-H64	H64-2	12.47	1,692.5	801	2,003	2586	-490.6			2,439.0	603	1,509	1642	-1533.8	
TSF-H65	H65-1	12.47	369.6	1,297	3,242	4405	1575.7			532.7	977	2,442	3921	932.5	
TSF-H65	H65-2	12.47	1,839.1	684	1,711	2323	-812.6			2,650.3	515	1,289	1342	-1877.2	
TSF-H66	H66-1	12.47	1,859.5	701	1,752	2319	-808.3			2,679.6	528	1,320	1326	-1887.9	
TSF-H66	H66-2	12.47	913.1	705	1,764	3270	145.0			1,315.9	531	1,328	2693	-518.9	
TSF-H67	H67-1	24.94	652.0	2,070	5,176	13708	2453.4			939.6	1,559	3,898	12909	1399.2	
TSF-H67	H67-2	24.94	219.4	2,020	5,051	14091	2811.4			316.1	1,522	3,804	13495	1966.5	
TSF-H68	H68-1	12.47	3,305.8	2,203	5,507	3627	-1.5			4,763.9	1,659	4,148	1625	-2275.3	
TSF-H68	H68-2	12.47	1,374.2	890	2,224	4245	-39.9			1,980.3	670	1,675	3420	-975.4	
TSF-H69	H69-1	12.47	2,324.4	1,903	4,758	4309	530.3			3,349.6	1,433	3,583	2814	-1199.6	

SUBSTATION	CKT	Primary Voltage (kV)	Existing Feeder Level										2016 Short Term			
			Total DG (kW) on Primary - 2014	Existing Primary Load (kVA)	Existing Primary Peak Load (kVA)	Existing 50% Backbone Capacity (kVA)	Remaining 50% Backbone Feeder Rating (kW)	Existing Feeder Level Remaining DG kW to 100% Gross DML	Existing Feeder Level Remaining DG kW to 120% Gross DML	Existing Feeder Level Remaining DG kW to 150% Gross DML	Total DG kW on Primary - 2016 Short Term	2016 Primary Min Load (kVA)	2016 Primary Peak Load (kVA)	Remaining DG to 50% Backbone Feeder Rating (kW)	2016 Feeder Level Remaining DG kW to 150% Gross DML	
TSF-H69	H69-2	12.47	542.6	1,122.0	2,805.0	4730	5309	579.4	803.8	1140.4	698.5	1,151	2,877	5182	1027.6	
TSF-H70	H70-1	12.47	824.2	871.6	2,179.0	4568	4616	47.4	221.7	483.2	1,240.9	894	2,235	4221	100.0	
TSF-H70	H70-2	12.47	301.6	1,713.2	4,283.0	4568	5980	1411.6	1754.2	2268.2	339.7	1,757	4,393	5985	2295.9	
TSF-H71	H71-1	11.5	127.4	699.6	1,749.0	4213	4785	572.2	712.1	922.0	143.4	717	1,794	4787	932.8	
TSF-H71	H71-2	11.5	2,052.9	1,638.0	4,095.0	4213	3798	-414.9	-87.3	404.1	2,311.7	1,680	4,200	3581	208.1	
TSF-H72	H72-1	11.5	465.3	1,564.8	3,912.0	4213	5312	1099.5	1412.5	1881.9	524.0	1,605	4,012	5294	1883.3	
TSF-H72	H72-2	11.5	4.7	1,048.4	2,621.0	4213	5256	1043.7	1253.4	1567.9	9.5	1,075	2,688	5279	1603.3	
TSF-H73	H73-1	12.47	1,585.3	1,797.2	4,493.0	3456	3668	211.9	571.4	1110.5	1,785.2	1,843	4,608	3514	979.6	
TSF-H73	H73-2	12.47	-	539.2	1,348.0	3456	3995	539.2	647.0	808.8	149.3	553	1,382	3859	680.2	
TSF-H74	H74-1	12.47	1,127.4	1,162.4	2,906.0	3456	3491	35.0	267.5	616.2	1,269.5	1,192	2,980	3378	518.7	
TSF-H75	H75-1	12.47	42.6	1,461.2	3,653.0	3456	4874	1394.2	1710.9	2149.2	264.7	1,671	4,177	4862	2241.6	
TSF-H76	H76-1	12.47	235.0	1,629.2	4,073.0	3456	4850	890.4	1084.5	1375.6	126.9	995	2,488	4702	1365.9	
TSF-H77	H77-1	12.47	80.0	970.4	2,426.0	3834	4724	890.4	1084.5	1375.6	34.3	1,401	3,502	4822	2067.1	
TSF-H78	H78-1	12.47	30.5	1,366.0	3,415.0	3456	4791	1335.5	1608.7	2018.5	386.0	1,124	2,809	5100	1299.4	
TSF-H79	H79-1	11.5	342.8	1,095.6	2,739.0	4362	5115	752.8	971.9	1300.6	483.6	1,993	4,983	5872	2506.3	
TSF-H79	H79-2	11.5	429.5	1,943.6	4,859.0	4362	5876	1514.1	1902.8	2485.9	620.1	1,330	3,324	4145	1374.2	
TSF-H80	H80-1	11.5	550.7	1,296.4	3,241.0	3436	4182	745.7	1005.0	1393.9	1,887.6	2,157	5,392	4632	1347.9	
TSF-H80	H80-2	11.5	1,676.3	2,103.2	5,258.0	4362	4789	426.9	847.6	1478.5	1,447.9	1,126	2,815	4040	241.2	
TSF-H81	H81-1	11.5	1,285.8	1,098.0	2,745.0	4362	4174	-187.8	31.8	361.2	1,809.9	2,445	6,113	4998	1858.1	
TSF-H81	H81-2	11.5	1,607.3	2,384.4	5,961.0	4362	5139	777.1	1254.0	1969.3	432.0	1,534	3,836	6070	1869.4	
TSF-H82	H82-1	12.47	383.6	1,496.0	3,740.0	4968	6080	1112.4	1411.6	1860.4	630.8	2,302	5,755	6639	2821.9	
TSF-H82	H82-2	12.47	560.2	2,244.4	5,611.0	4968	6652	1684.2	2133.1	2806.4	57.4	192	480	1219	230.6	
TSF-H83	H83-1	4.16	477.1	499.2	1,248.0	1084	1107	22.1	122.0	271.7	85.8	40	101	873	-25.5	
TSF-H83	H83-2	4.16	51.0	187.2	468.0	1084	1221	136.2	173.7	229.8	289.4	1,277	3,194	5956	1626.8	
TSF-H83	H83-3	4.16	76.2	39.2	98.0	919	882	-37.0	-29.1	-17.4	1,508.2	1,635	4,088	5095	944.6	
TSF-H84	H84-1	12.47	249.8	1,245.6	3,114.0	4968	5964	995.8	1244.9	1618.6	117.4	232	579	1274	230.2	
TSF-H84	H84-2	12.47	1,339.3	1,594.4	3,986.0	4968	5223	255.1	573.9	1052.3	312.6	486	1,215	1092	416.5	
TSF-H85	H85-1	4.16	5.5	226.0	565.0	1160	1381	220.5	265.7	333.5	372.8	160	400	4053	-132.9	
TSF-H85	H85-2	4.16	226.3	474.0	1,185.0	919	1166	247.7	342.5	484.7	502.1	901	2,253	3775	849.9	
TSF-H86	H86-1	12.47	268.9	156.0	390.0	4266	4153	-112.9	-81.7	-34.9	1,352.4	1,963	4,908	3987	1592.6	
TSF-H87	H87-1	11.5	445.8	878.8	2,197.0	3376	3809	433.0	608.7	872.4	497.7	95	238	2974	-355.0	
TSF-H88	H88-1	11.5	1,201.0	1,914.4	4,786.0	3376	4090	713.4	1096.3	1670.6	113.4	1,203	3,008	4466	1691.4	
TSF-H89	H89-1	11.5	-	92.8	232.0	3376	3469	92.8	111.4	139.2	527.5	2,416	6,041	5265	3096.9	
TSF-H89	H89-2	11.5	100.7	1,173.2	2,933.0	3376	4449	1072.5	1307.1	1659.1	113.4	1,203	3,008	4466	1691.4	
TSF-H90	H90-1	11.5	468.5	2,356.0	5,890.0	3376	5264	1887.5	2358.7	3065.5	2,265.3	1,573	3,932	4038	94.0	
TSF-H91	H91-1	12.47	1,913.8	1,533.6	3,834.0	4730	4350	-380.2	-73.5	386.6	2,193.5	1,355	3,389	3892	-160.4	
TSF-H91	H91-2	12.47	1,947.9	1,321.6	3,304.0	4730	4104	-626.3	-362.0	34.5	2,681.0	1,714	4,284	3763	-110.7	
TSF-H92	H92-1	12.47	2,370.9	1,670.8	4,177.0	4730	4030	-700.1	-366.0	135.3	2,681.0	1,714	4,284	3763	-110.7	
TSF-H92	H92-2	12.47	1,109.9	1,289.2	3,223.0	4730	4909	179.3	700.1	823.9	77.9	1,202	3,006	5444	1725.6	
TSF-H93	H93-1	12.47	22.7	1,172.4	2,931.0	4320	5469	1149.7	1384.2	1735.9	122.7	960	2,399	5405	1316.6	
TSF-H94	H94-1	12.47	5.5	935.6	2,339.0	4568	5498	930.1	1117.2	1397.9						

SUBSTATION	CKT	Primary Voltage (kV)	2020 Short Term				2020 Feeder Level				2030 Long Term				2030 Feeder Level Remaining DG kW to 150% Gross DML
			Total DG kW on Primary - 2020 Mid Term	2020 Primary Min Load (kVA)	2020 Primary Peak Load (kVA)	Remaining DG to 50% Backbone Feeder Rating (kW)	Total DG kW on Primary - 2020 Mid Term	2020 Primary Min Load (kVA)	2020 Primary Peak Load (kVA)	Remaining DG to 50% Backbone Feeder Rating (kW)	Total DG kW on Primary - 2030 Long Term	2030 Primary Min Load (kVA)	2030 Primary Peak Load (kVA)	Remaining DG to 50% Backbone Feeder Rating (kW)	
TSF-H69	H69-2	12.47	907.1	1,184	2,960	5007	869.2	1,307.2	892	2,230	4315	30.6			
TSF-H70	H70-1	12.47	1,611.5	920	2,300	3877	-231.7	2,322.3	693	1,732	2939	-1283.1			
TSF-H70	H70-2	12.47	441.1	1,808	4,520	5935	2271.1	635.7	1,362	3,404	5294	1407.0			
TSF-H71	H71-1	11.5	186.3	738	1,846	4765	921.3	268.5	556	1,390	4500	565.7			
TSF-H71	H71-2	11.5	3,002.3	1,729	4,322	2939	-409.1	4,326.5	1,302	3,255	1188	-2373.4			
TSF-H72	H72-1	11.5	680.5	1,652	4,129	5184	1796.8	980.6	1,244	3,110	4476	885.2			
TSF-H72	H72-2	11.5	12.3	1,106	2,766	5307	1647.4	17.8	833	2,083	5028	1232.3			
TSF-H73	H73-1	12.47	2,318.4	1,897	4,742	3034	526.8	3,341.0	1,429	3,571	1543	-1198.2			
TSF-H73	H73-2	12.47	193.9	569	1,423	3831	659.7	279.4	429	1,072	3605	363.5			
TSF-H74	H74-1	12.47	1,648.7	1,227	3,067	3034	191.5	2,376.0	924	2,310	2004	-990.0			
TSF-H74	H74-2	12.47	62.2	1,542	3,855	4936	2251.0	89.7	1,161	2,904	4528	1652.5			
TSF-H76	H76-1	12.47	343.7	1,719	4,299	4832	2235.5	495.3	1,295	3,238	4255	1447.2			
TSF-H77	H77-1	12.47	164.9	1,024	2,560	4693	1371.4	237.6	771	1,928	4368	919.5			
TSF-H78	H78-1	12.47	44.6	1,442	3,604	4853	2117.9	64.3	1,086	2,715	4477	1564.4			
TSF-H79	H79-1	11.5	501.4	1,156	2,891	5017	1233.1	722.5	871	2,177	4511	583.8			
TSF-H79	H79-2	11.5	628.1	2,051	5,128	5785	2448.9	905.1	1,545	3,862	5002	1412.3			
TSF-H80	H80-1	11.5	805.4	1,368	3,421	3999	1247.0	1,160.6	1,030	2,576	3306	385.1			
TSF-H80	H80-2	11.5	2,451.5	2,220	5,549	4130	878.2	3,532.7	1,672	4,180	2501	-1025.0			
TSF-H81	H81-1	11.5	1,880.4	1,159	2,897	3641	-142.1	2,709.8	873	2,182	2525	-1400.6			
TSF-H81	H81-2	11.5	2,350.6	2,517	6,291	4528	1424.2	3,387.3	1,895	4,738	2870	-544.4			
TSF-H82	H82-1	12.47	561.0	1,579	3,947	5986	1807.3	808.5	1,189	2,973	5348	975.3			
TSF-H82	H82-2	12.47	819.2	2,369	5,922	6517	2733.9	1,180.5	1,784	4,460	5571	1495.5			
TSF-H83	H83-1	4.16	697.7	527	1,317	914	92.6	1,005.4	397	992	476	-410.2			
TSF-H83	H83-2	4.16	74.5	198	494	1207	221.8	107.4	149	372	1126	115.8			
TSF-H83	H83-3	4.16	111.4	41	103	849	-49.4	160.6	31	78	789	-113.8			
TSF-H84	H84-1	12.47	375.8	1,315	3,287	5907	1596.1	541.6	990	2,475	5416	943.6			
TSF-H84	H84-2	12.47	1,958.7	1,683	4,207	4692	565.4	2,822.7	1,267	3,168	3412	-921.6			
TSF-H85	H85-1	4.16	152.5	239	596	1246	205.3	219.8	180	449	1120	49.7			
TSF-H85	H85-2	4.16	406.0	500	1,251	1013	344.4	585.1	377	942	710	-20.0			
TSF-H86	H86-1	12.47	484.2	165	412	3946	-237.2	697.8	124	310	3692	-511.8			
TSF-H87	H87-1	11.5	652.0	927	2,319	3652	739.2	939.6	699	1,746	3135	108.2			
TSF-H88	H88-1	11.5	1,756.4	2,020	5,051	3640	1274.3	2,531.1	1,522	3,804	2367	-248.6			
TSF-H89	H89-1	11.5	646.4	98	245	2828	-499.5	931.5	74	184	2518	-820.9			
TSF-H89	H89-2	11.5	147.3	1,238	3,096	4467	1710.1	212.2	933	2,331	4097	1186.6			
TSF-H90	H90-1	11.5	685.1	2,487	6,216	5178	3044.7	987.3	1,873	4,682	4262	1821.8			
TSF-H91	H91-1	12.47	2,941.9	1,619	4,046	3407	-514.0	4,239.5	1,219	3,048	1710	-2410.9			
TSF-H91	H91-2	12.47	2,848.7	1,395	3,487	3276	-756.5	4,105.2	1,051	2,626	1675	-2529.4			
TSF-H92	H92-1	12.47	3,481.9	1,763	4,408	3012	-836.8	5,017.7	1,328	3,320	1041	-3025.5			
TSF-H92	H92-2	12.47	1,623.2	1,361	3,402	4468	417.7	2,339.2	1,025	2,562	3416	-802.1			
TSF-H93	H93-1	12.47	101.2	1,237	3,093	5456	1754.8	145.9	932	2,330	5106	1252.0			
TSF-H94	H94-1	12.47	159.3	987	2,469	5396	1321.8	229.6	744	1,859	5082	885.9			

SUBSTATION	CKT	Primary Voltage (kV)	Existing										2016 Short				
			Total DG (kW) on Primary - 2014	Existing Primary Load (kVA)	Existing Primary Min Load (kVA)	Existing Primary Peak Load (kVA)	Existing 50% Backbone Capacity (kVA)	Existing Remaining 50% Backbone Feeder Rating (kW)	Existing Feeder Level Remaining DG kW to 100% Gross DML	Existing Feeder Level Remaining DG kW to 120% Gross DML	Existing Feeder Level Remaining DG kW to 150% Gross DML	Total DG kW on Primary - 2016 Short Term	2016 Primary Min Load (kVA)	2016 Primary Peak Load (kVA)	Remaining to 50% Backbone Feeder Rating (kW)	2016 Remaining DG kW to 150% Gross DML	
TSF-H95	H95-1	24.94	254.8	2,599.6	6,499.0	6415	8760	2344.8	2864.8	3644.6	337.8	2,666	6,665	8743	3661.3		
TSF-H95	H95-2	24.94	324.5	1,432.4	3,581.0	6415	7523	1107.9	1394.4	1824.1	365.4	1,469	3,673	7518	1838.1		
TSF-H96	H96-1	12.47	179.4	1,953.6	4,884.0	5421	7195	1774.2	2164.9	2751.0	202.0	2,004	5,009	7223	2803.4		
TSF-H97	H97-1	12.47	1,963.7	1,360.4	3,401.0	5562	4958	-603.3	-331.2	76.9	2,211.2	1,395	3,488	4746	-118.5		
TSF-H97	H97-2	12.47	2,027.4	1,814.0	4,535.0	5562	5348	-213.4	149.4	693.6	2,283.0	1,860	4,651	5139	507.6		
TSF-H98	H98-1	12.47	1,081.6	1,163.6	2,909.0	4730	4812	82.0	314.7	663.8	1,218.0	1,193	2,983	4705	572.0		
TSF-H98	H98-2	12.47	505.4	1,304.0	3,260.0	4730	5529	798.6	1059.4	1450.6	569.1	1,337	3,343	5498	1436.9		
TSF-H99	H99-1	12.47	1,867.6	1,344.4	3,361.0	4568	4045	-523.2	-254.4	149.0	2,103.1	1,379	3,447	3844	-35.0		
TSF-H99	H99-2	12.47	1,179.1	1,136.0	2,840.0	4568	4525	-43.1	184.1	524.9	1,327.8	1,165	2,913	4405	419.8		
TSF-H100	H100-1	12.47	49.1	1,374.0	3,435.0	3456	4781	1324.9	1599.7	2011.9	55.3	1,409	3,523	4810	2058.4		
TSF-H100	H100-1	11.5	373.0	968.0	2,420.0	5129	5724	595.0	788.6	1079.0	472.1	993	2,482	5650	1017.0		
TSF-H102	H102-1	11.5	-	466.4	1,166.0	1693	2159	466.4	559.7	699.6	27.0	478	1,196	2144	690.5		
TSF-H103	H103-1	12.47	995.8	837.6	2,094.0	4266	4108	-158.2	9.4	260.6	1,216.9	859	2,148	3908	711.6		
TSF-H103	H103-2	12.47	1,796.5	1,841.2	4,603.0	4266	4310	44.7	412.9	965.3	2,161.0	1,888	4,721	3993	671.4		
TSF-H104	H104-1	12.47	1,959.1	1,742.4	4,356.0	4266	4049	-216.2	131.7	654.5	2,206.2	1,787	4,467	3847	474.3		
TSF-H104	H104-2	12.47	857.9	509.2	1,273.0	4266	3917	-348.7	-246.9	-94.3	1,003.1	522	1,306	3785	-219.7		
TSF-H105	H105-1	4.16	292.9	509.6	1,274.0	1099	1316	216.7	318.6	471.5	397.0	523	1,307	1224	386.9		
TSF-H106	H106-1	4.16	135.7	311.2	778.0	1704	1880	175.5	237.8	331.1	246.6	319	798	1777	232.2		
TSF-H106	H106-2	4.16	208.4	276.4	691.0	1704	1772	68.0	123.3	206.2	255.9	283	709	1732	169.3		
TSF-H107	H107-1	11.5	361.7	1,082.8	2,707.0	5000	5721	721.1	937.6	1262.5	407.3	1,110	2,776	5703	1258.4		
TSF-H107	H107-2	11.5	764.3	722.0	1,805.0	5000	4957	-42.3	102.1	318.7	860.7	740	1,851	4879	250.0		
TSF-H108	H108-1	11.5	1,444.3	1,465.6	3,664.0	2520	2541	21.3	314.5	754.1	1,626.4	1,503	3,758	2396	628.3		
TSF-H108	H108-2	11.5	237.1	725.2	1,813.0	1783	2271	488.1	633.1	850.7	267.0	744	1,859	2259	848.6		
TSF-H109	H109-1	11.5	79.2	1,642.4	4,106.0	4362	5925	1563.2	1891.7	2384.4	89.2	1,684	4,211	5957	2437.4		
TSF-H109	H109-2	11.5	1,265.2	1,051.2	2,628.0	4213	3999	-214.0	-3.8	311.6	1,424.8	1,078	2,695	3866	192.4		
TSF-H110	H110-1	12.47	1,283.9	2,504.8	6,262.0	5108	6329	1220.9	1721.9	2473.3	1,675.0	2,569	6,422	6002	2178.3		
TSF-H111	H111-1	12.47	66.1	1,483.6	3,709.0	5108	6526	1417.5	1714.3	2159.3	74.4	1,522	3,804	6555	2207.9		
TSF-H111	H111-2	12.47	1,303.7	2,488.4	6,221.0	5108	6293	1184.7	1682.4	2428.9	2,032.5	2,552	6,380	5628	1795.6		
TSF-H112	H112-1	12.47	1,040.9	1,360.0	3,400.0	4266	4585	319.1	591.1	999.1	1,313.4	1,395	3,487	4347	778.8		
TSF-H112	H112-2	12.47	1,747.8	1,568.0	3,920.0	4266	4086	-179.8	133.8	604.2	1,968.2	1,608	4,020	3906	444.0		
TSF-H113	H113-1	12.47	2,114.4	1,434.0	3,585.0	4266	3585	-680.4	-393.6	36.6	2,530.4	1,471	3,677	3206	-324.4		
TSF-H113	H113-2	12.47	595.1	750.0	1,875.0	4266	4421	154.9	304.9	529.9	670.1	769	1,923	4365	483.7		
TSF-H114	H114-1	11.5	1,590.0	2,410.8	6,027.0	4213	5034	820.8	1303.0	2026.2	1,790.5	2,472	6,181	4895	1918.2		
TSF-H114	H114-2	11.5	1,238.5	962.8	2,407.0	4213	3937	-275.7	-83.1	205.7	1,500.1	987	2,469	3700	-19.0		
TSF-H115	H115-1	11.5	1,727.0	1,702.8	4,257.0	4213	4189	-24.2	316.4	827.2	1,944.7	1,746	4,366	4014	674.8		
TSF-H115	H115-2	11.5	1,817.8	1,297.2	3,243.0	4213	3692	-520.6	-261.2	128.0	2,130.6	1,330	3,326	3413	-135.0		
TSF-H116	H116-1	12.47	97.5	845.2	2,113.0	4050	4797	747.7	916.7	1170.3	109.8	867	2,167	4807	1190.4		
TSF-H116	H116-2	12.47	194.9	946.8	2,367.0	4050	4802	751.9	941.3	1225.3	219.5	971	2,428	4801	1237.1		
TSF-H117	H117-1	12.47	222.9	1,004.8	2,512.0	3456	4238	781.9	982.8	1284.3	251.0	1,030	2,576	4235	1294.7		
TSF-H118	H118-1	12.47	-	879.6	2,199.0	3456	4335	879.6	1055.5	1319.4	112.6	902	2,255	4245	1240.5		
TSF-H118	H118-2	12.47	3.1	1,729.6	4,324.0	3456	5182	1726.5	2072.4	2591.3	3.5	1,774	4,435	5226	2657.2		

SUBSTATION	CKT	Primary Voltage (kV)	2020 Short Term				2030 Long Term					
			Total DG kW on Primary - 2020 Mid Term	2020 Primary Min Load (kVA)	2020 Primary Peak Load (kVA)	Remaining DG to 50% Backbone Feeder Rating (kW)	Total DG kW on Primary - 2030 Long Term	2030 Primary Min Load (kVA)	2030 Primary Peak Load (kVA)	Remaining DG to 50% Backbone Feeder Rating (kW)	2030 Feeder Level Remaining DG kW to 150% Gross DML	
TSF-H95	H95-1	24.94	488.7	2,744	6,859	8720	3676.7	632.3	2,066	5,166	7849	2467.3
TSF-H95	H95-2	24.94	474.6	1,512	3,779	7452	1793.1	683.9	1,139	2,846	6869	1024.0
TSF-H96	H96-1	12.47	262.3	2,062	5,155	7221	2830.5	378.0	1,553	3,882	6596	1951.3
TSF-H97	H97-1	12.47	2,871.8	1,436	3,589	4126	-718.1	4,138.4	1,081	2,703	2505	-2516.4
TSF-H97	H97-2	12.47	2,965.0	1,915	4,786	4511	-93.2	4,272.8	1,442	3,605	2731	-2109.9
TSF-H98	H98-1	12.47	1,581.9	1,228	3,070	4376	260.3	2,279.6	925	2,312	3375	892.2
TSF-H98	H98-2	12.47	791.1	1,376	3,441	5367	1325.2	1,065.2	1,037	2,591	4701	489.6
TSF-H99	H99-1	12.47	2,731.4	1,419	3,547	3256	-603.0	3,936.1	1,069	2,672	1701	-2333.1
TSF-H99	H99-2	12.47	1,724.4	1,199	2,997	4043	74.0	2,485.0	903	2,257	2986	-1130.5
TSF-H100	H100-1	12.47	71.9	1,450	3,625	4834	2103.3	103.6	1,092	2,730	4444	1534.7
TSF-H100	H101-1	11.5	613.2	1,022	2,554	5537	919.3	883.6	769	1,924	5015	270.5
TSF-H102	H102-1	11.5	35.1	492	1,231	2150	703.3	50.6	371	927	2013	505.5
TSF-H103	H103-1	12.47	1,580.4	884	2,210	3569	-254.4	2,277.5	666	1,664	2654	-1278.8
TSF-H103	H103-2	12.47	2,806.5	1,843	4,858	3402	108.3	4,044.4	1,464	3,659	1685	-1849.1
TSF-H104	H104-1	12.47	2,865.2	1,839	4,597	3240	-106.7	4,128.9	1,385	3,463	1522	-2051.4
TSF-H104	H104-2	12.47	1,302.7	537	1,344	3500	-496.6	1,877.3	405	1,012	2793	-1270.1
TSF-H105	H105-1	4.16	515.6	538	1,345	1121	291.2	743.0	405	1,013	761	-135.4
TSF-H106	H106-1	4.16	320.2	328	821	1712	172.4	461.5	247	618	1490	-90.4
TSF-H106	H106-2	4.16	332.3	292	729	1663	105.3	478.9	220	549	1445	-149.3
TSF-H107	H107-1	11.5	529.0	1,143	2,857	5613	1185.2	762.3	861	2,152	5098	528.7
TSF-H107	H107-2	11.5	1,117.8	762	1,905	4644	25.2	1,610.8	574	1,435	3963	-749.9
TSF-H108	H108-1	11.5	2,112.2	1,547	3,867	1954	208.1	3,043.8	1,165	2,912	641	-1296.3
TSF-H108	H108-2	11.5	346.8	765	1,913	2201	801.3	499.8	576	1,441	1859	364.9
TSF-H109	H109-1	11.5	115.8	1,733	4,334	5980	2484.3	166.9	1,306	3,264	5501	1791.4
TSF-H109	H109-2	11.5	1,850.4	1,109	2,774	3472	-186.2	2,666.5	836	2,089	2382	-1413.1
TSF-H110	H110-1	12.47	2,175.3	2,644	6,609	5576	1790.1	3,134.8	1,991	4,978	3964	-148.2
TSF-H111	H111-1	12.47	96.6	1,566	3,915	6577	2252.1	139.2	1,179	2,948	6148	1629.7
TSF-H111	H111-2	12.47	2,639.6	2,626	6,566	5095	1299.9	3,803.8	1,978	4,945	3282	-836.8
TSF-H112	H112-1	12.47	1,705.7	1,435	3,588	3995	447.3	2,458.1	1,081	2,703	2889	836.5
TSF-H112	H112-2	12.47	2,556.1	1,655	4,137	3365	-73.7	3,683.5	1,246	3,116	1829	-1813.9
TSF-H113	H113-1	12.47	3,286.2	1,513	3,784	2493	-1016.0	4,735.7	1,140	2,850	670	-3025.9
TSF-H113	H113-2	12.47	870.3	792	1,979	4187	317.0	1,254.2	596	1,490	3608	-359.9
TSF-H114	H114-1	11.5	2,325.3	2,544	6,361	4432	1491.3	3,350.9	1,916	4,791	2778	-476.5
TSF-H114	H114-2	11.5	1,948.2	1,016	2,540	3281	-424.0	2,807.5	765	1,913	2171	-1659.5
TSF-H115	H115-1	11.5	2,525.6	1,797	4,493	3484	170.1	3,639.6	1,354	3,384	1927	-1609.3
TSF-H115	H115-2	11.5	2,767.0	1,369	3,423	2815	-713.4	3,987.5	1,031	2,578	1256	-2440.8
TSF-H116	H116-1	12.47	142.6	892	2,230	4799	1195.5	205.5	672	1,680	4516	802.3
TSF-H116	H116-2	12.47	285.0	999	2,498	4764	1213.9	410.7	753	1,881	4392	718.1
TSF-H117	H117-1	12.47	326.0	1,060	2,651	4190	1264.7	469.8	799	1,997	3785	728.2
TSF-H118	H118-1	12.47	146.2	928	2,321	4238	1246.3	210.8	699	1,748	3944	838.0
TSF-H118	H118-2	12.47	4.6	1,825	4,564	5277	2733.6	6.6	1,375	3,437	4824	2055.7

SUBSTATION	CKT	Primary Voltage (kV)	Existing Feeder Level										2016 Short Term			2016 Feeder Level Remaining DG to 50% Backbone Feeder Rating
			Total DG (kW) on Primary - 2014	Existing Primary Min Load (kW)	Existing Primary Peak Load (kW)	Existing 50% Backbone Capacity (kVA)	Existing 50% Backbone Feeder Rating (kW)	Remaining DG to 50% Backbone Feeder Rating 100% Gross DML	Remaining DG to 50% Backbone Feeder Rating 120% Gross DML	Remaining DG to 50% Backbone Feeder Rating 150% Gross DML	2016 Primary Min Load (kVA)	2016 Primary Peak Load (kVA)	Total DG kW on Primary - 2016 Short Term	2016 Remaining DG to 50% Backbone Feeder Rating (kW)		
TSF-H119	H119-1	12.47	228.8	1,283.6	3,209.0	3456	4511	1054.8	1311.6	1696.6	1696.6	257.6	1,316	3,291	4515	1717.0
TSF-H119	H119-2	12.47	-	1,526.4	3,816.0	3456	4982	1526.4	1831.7	2289.6	2289.6	491.0	1,565	3,914	4530	1857.2
TSF-H120	H120-1	12.47	400.0	2,290.8	5,727.0	4730	6621	1890.8	2349.0	3036.2	3036.2	450.4	2,349	5,873	6629	3073.7
TSF-H121	H121-1	12.47	1,408.2	2,436.0	6,090.0	4730	5758	1027.8	1515.0	2245.8	2245.8	1,585.8	2,498	6,246	5643	2161.6
TSF-H122	H122-1	12.47	261.8	1,100.4	2,751.0	4568	5407	838.6	1058.6	1388.8	1388.8	510.4	1,129	2,821	5186	1182.4
TSF-H123	H123-1	12.47	1,362.5	1,611.6	4,029.0	4568	4817	249.1	571.5	1054.9	1,534.3	1,534.3	1,653	4,132	4687	945.0
TSF-H124	H124-1	4.16	937.3	1,667.2	4,168.0	731	1461	729.9	1063.3	1563.5	1,055.5	1,055.5	1,710	4,275	1386	1509.3
TSF-H125	H125-1	4.16	300.5	239.2	598.0	793	731	61.3	13.4	58.3	38.4	38.4	245	613	700	29.6
TSF-H126	H126-1	11.5	876.0	1,668.0	4,170.0	4362	5154	792.0	1125.6	1626.0	986.5	1,711	4,277	5086	1579.5	
TSF-H126	H126-2	11.5	160.7	978.0	2,445.0	4362	5179	817.3	1012.9	1306.3	291.7	1,003	2,508	5073	1212.8	
TSF-H127	H127-1	11.5	491.7	675.2	1,688.0	4362	4546	183.5	318.5	521.1	554.7	692	1,731	4500	484.0	
TSF-H127	H127-2	11.5	368.1	964.8	2,412.0	4362	4959	596.7	789.7	1079.1	414.5	989	2,474	4937	1069.7	
TSF-H128	H128-1	12.47	31.9	1,074.4	2,686.0	3197	4239	1042.5	1257.3	1579.7	36.0	1,102	2,755	4263	1616.9	
TSF-H128	H128-2	12.47	422.7	1,541.2	3,853.0	3197	4315	1118.5	1426.8	1889.1	476.0	1,581	3,952	4301	1895.0	
TSF-H129	H129-1	12.47	341.6	1,782.4	4,456.0	3197	4637	1440.8	1797.3	2332.0	384.7	1,828	4,570	4640	2357.3	
TSF-H130	H130-1	12.47	56.4	1,205.2	3,013.0	3197	4345	1148.8	1389.8	1751.4	257.3	1,236	3,090	4175	1596.8	
TSF-H130	H130-2	12.47	322.2	1,154.8	2,887.0	3197	4029	832.6	1063.6	1410.0	362.8	1,184	2,961	4018	1413.7	
TSF-H131	H131-1	12.47	613.9	1,540.0	3,850.0	5184	6110	926.1	1234.1	1696.1	719.9	1,579	3,948	6043	1649.2	
TSF-H132	H132-1	12.47	2,541.7	1,530.0	3,825.0	5562	4550	-1011.7	-705.7	-246.7	2,862.1	1,569	3,923	4269	-508.4	
TSF-H132	H132-2	12.47	823.3	857.2	2,143.0	5421	5455	33.9	205.4	462.5	1,001.2	879	2,198	5299	317.5	
TSF-H133	H133-1	12.47	2,317.0	2,120.0	5,300.0	5421	5224	-197.0	227.0	863.0	3,039.3	2,174	5,436	4556	222.0	
TSF-H134	H134-1	12.47	1,640.6	1,162.8	2,907.0	4568	4090	-477.8	-245.3	103.6	1,847.5	1,193	2,981	3913	-58.7	
TSF-H134	H134-2	12.47	1,020.9	1,536.4	3,841.0	4730	5246	515.5	822.8	1283.7	1,149.6	1,576	3,939	5156	1213.9	
TSF-H135	H135-1	12.47	369.5	1,084.4	2,711.0	4568	5283	714.9	931.8	1257.1	848.4	1,112	2,780	4832	819.8	
TSF-H135	H135-2	12.47	1,987.0	1,636.0	4,090.0	4568	4217	-351.0	-23.8	467.0	2,237.6	1,678	4,195	4008	279.2	
TSF-H136	H136-1	12.47	433.0	1,558.8	3,897.0	5421	6547	1125.8	1437.5	1905.2	508.7	1,599	3,997	6511	1889.3	
TSF-H136	H136-2	12.47	108.5	1,287.6	3,219.0	5421	6600	1179.1	1436.6	1822.9	122.2	1,321	3,301	6620	1858.6	
TSF-H137	H137-1	11.5	985.3	1,343.2	3,358.0	5000	5357	357.9	626.5	1029.5	1,109.5	1,378	3,444	5268	956.8	
TSF-H138	H138-1	12.47	867.3	733.6	1,834.0	5562	5428	-133.7	13.0	233.1	976.6	752	1,881	5337	151.9	
TSF-H139	H139-1	12.47	1,717.8	2,204.0	5,510.0	5562	6048	486.2	927.0	1588.2	1,934.4	2,260	5,651	5888	1456.1	
TSF-H140	H140-1	12.47	1,485.2	524.8	1,312.0	4266	3305	-560.4	-855.4	-698.0	2,262.9	538	1,346	2541	-1455.6	
TSF-H140	H140-2	12.47	1,358.7	1,223.2	3,058.0	4266	4130	-135.5	109.1	476.1	1,576.1	1,254	3,136	3944	305.6	
TSF-H141	H141-1	12.47	1,373.7	1,093.6	2,734.0	4266	3986	-280.1	-61.4	266.7	1,546.9	1,122	2,804	3840	135.5	
TSF-H141	H141-2	12.47	463.1	202.4	506.0	4266	4005	-260.7	-220.2	-159.5	709.6	208	519	3764	-398.3	
TSF-H142	H142-1	12.47	811.5	693.2	1,733.0	5562	5443	-118.3	20.3	228.3	1,136.3	711	1,777	5136	-69.9	
TSF-H142	H142-2	12.47	1,823.9	2,285.2	5,713.0	5562	6023	461.3	918.4	1603.9	2,068.8	2,344	5,859	5836	1446.7	
TSF-H143	H143-1	11.5	1,081.5	1,134.8	2,837.0	4581	4635	53.3	280.3	620.7	1,217.8	1,164	2,910	4527	527.9	
TSF-H143	H143-2	11.5	622.6	2,033.6	5,084.0	4581	5992	1411.0	1817.7	2427.8	824.4	2,086	5,214	5842	2304.0	
TSF-H144	H144-1	12.47	530.5	1,736.4	4,341.0	4662	4662	1205.9	1553.1	2074.1	651.4	1,781	4,452	4585	2019.8	
TSF-H144	H144-2	12.47	108.9	1,183.6	2,959.0	3456	4530	1074.7	1311.4	1666.5	122.6	1,214	3,035	4547	1698.2	
TSF-H145	H145-1	12.47	996.4	1,776.8	4,442.0	3456	4236	780.4	1135.7	1668.8	1,122.1	1,822	4,556	4156	1611.3	

SUBSTATION	CKT	Primary Voltage (kV)	2020 Short Term				2030 Long Term						
			Total DG kW on Primary - 2020 Mid Term	2020 Primary Min Load (kVA)	2020 Primary Peak Load (kVA)	Remaining DG to 50% Backbone Feeder Rating (kW)	Total DG kW on Primary - 2030 Long Term	2030 Primary Min Load (kVA)	2030 Primary Peak Load (kVA)	Remaining DG to 50% Backbone Feeder Rating (kW)			
TSF-H119	H119-1	12.47	334.5	1,355	3,387	4476	1697.5	482.1	1,020	2,551	3994	3994	1048.4
TSF-H119	H119-2	12.47	637.6	1,611	4,027	4429	1778.8	918.9	1,213	3,033	3750	3750	901.1
TSF-H120	H120-1	12.47	585.0	2,418	6,044	6563	3041.6	843.0	1,821	4,552	5708	5708	1888.4
TSF-H121	H121-1	12.47	2,059.5	2,571	6,427	5242	1797.0	2,967.9	1,936	4,841	3699	3699	-63.4
TSF-H122	H122-1	12.47	662.8	1,161	2,903	5067	1079.2	955.2	875	2,187	4488	4488	356.9
TSF-H123	H123-1	12.47	1,992.5	1,701	4,252	4276	558.8	2,871.4	1,281	3,203	2978	2978	-949.9
TSF-H124	H124-1	4.16	1,370.8	1,760	4,399	1120	1268.6	1,975.4	1,325	3,313	81	81	12.5
TSF-H125	H125-1	4.16	439.4	252	631	606	-60.8	633.3	190	475	349	349	-348.2
TSF-H126	H126-1	11.5	1,281.1	1,760	4,401	4841	1359.5	1,846.2	1,326	3,315	3842	3842	142.6
TSF-H126	H126-2	11.5	378.8	1,032	2,580	5016	1169.5	545.9	777	1,943	4594	4594	620.2
TSF-H127	H127-1	11.5	720.3	713	1,782	4354	348.6	1,038.1	537	1,342	3861	3861	-233.0
TSF-H127	H127-2	11.5	538.3	1,018	2,546	4842	989.1	775.7	767	1,917	4353	4353	374.7
TSF-H128	H128-1	12.47	46.7	1,134	2,835	4284	1654.2	67.3	854	2,135	3983	3983	1213.7
TSF-H128	H128-2	12.47	618.1	1,627	4,067	4205	1821.8	890.8	1,225	3,063	3531	3531	946.8
TSF-H129	H129-1	12.47	499.6	1,881	4,703	4578	2322.2	719.9	1,417	3,542	3893	3893	1405.3
TSF-H130	H130-1	12.47	334.1	1,272	3,180	4134	1573.8	481.5	958	2,395	3673	3673	955.5
TSF-H130	H130-2	12.47	471.2	1,219	3,047	3944	1357.0	679.0	918	2,295	3436	3436	697.9
TSF-H131	H131-1	12.47	934.9	1,625	4,063	5874	1503.1	1,347.2	1,224	3,060	5061	5061	488.9
TSF-H132	H132-1	12.47	3,717.1	1,615	4,037	3459	-1294.9	5,356.6	1,216	3,040	1421	1421	-3532.3
TSF-H132	H132-2	12.47	1,300.2	905	2,262	5026	56.8	1,873.7	681	1,703	4229	4229	-851.7
TSF-H133	H133-1	12.47	3,947.1	2,237	5,594	3712	-590.9	5,688.1	1,685	4,213	1418	1418	-3160.4
TSF-H134	H134-1	12.47	2,399.4	1,227	3,068	3396	-558.5	3,457.7	924	2,311	2035	2035	-2071.2
TSF-H134	H134-2	12.47	1,493.0	1,622	4,054	4859	939.3	2,151.5	1,221	3,053	3800	3800	-319.6
TSF-H135	H135-1	12.47	1,101.8	1,144	2,861	4611	614.9	1,587.8	862	2,155	3842	3842	-294.8
TSF-H135	H135-2	12.47	2,905.9	1,727	4,317	3389	-316.0	4,187.7	1,300	3,251	1681	1681	-2237.0
TSF-H136	H136-1	12.47	660.7	1,645	4,113	6406	1807.1	952.1	1,239	3,098	5708	5708	906.5
TSF-H136	H136-2	12.47	158.6	1,359	3,397	6622	1879.8	228.6	1,023	2,559	6216	6216	1306.6
TSF-H137	H137-1	11.5	1,441.0	1,418	3,544	4976	685.5	2,076.5	1,068	2,669	3991	3991	-475.0
TSF-H138	H138-1	12.47	1,268.4	774	1,936	5068	-107.0	1,827.8	583	1,458	4317	4317	-953.1
TSF-H139	H139-1	12.47	2,512.3	2,326	5,815	5376	976.9	3,620.4	1,752	4,380	3693	3693	-992.5
TSF-H140	H140-1	12.47	2,938.9	554	1,385	1881	-2108.1	4,235.2	417	1,043	448	448	-3609.4
TSF-H140	H140-2	12.47	2,047.0	1,291	3,227	3510	-110.5	2,949.8	972	2,431	2288	2288	-1491.4
TSF-H141	H141-1	12.47	2,009.0	1,154	2,886	3411	-277.7	2,895.1	869	2,173	2240	2240	-1591.1
TSF-H141	H141-2	12.47	921.6	214	534	3558	-601.2	1,328.1	161	402	3098	3098	-1086.8
TSF-H142	H142-1	12.47	1,475.7	732	1,829	4818	-378.3	2,126.6	551	1,378	3986	3986	-1300.1
TSF-H142	H142-2	12.47	2,686.8	2,412	6,030	5287	931.0	3,871.9	1,816	4,541	3506	3506	-1147.2
TSF-H143	H143-1	11.5	1,581.6	1,198	2,994	4197	214.9	2,279.2	902	2,255	3204	3204	-926.2
TSF-H143	H143-2	11.5	1,070.7	2,146	5,366	5657	2148.7	1,543.0	1,616	4,041	4655	4655	881.7
TSF-H144	H144-1	12.47	846.0	1,833	4,582	4442	1903.0	1,219.1	1,380	3,451	3617	3617	851.3
TSF-H144	H144-2	12.47	159.3	1,249	3,123	4546	1714.5	229.5	941	2,352	4167	4167	1181.7
TSF-H145	H145-1	12.47	1,457.2	1,875	4,688	3874	1355.7	2,100.0	1,412	3,531	2768	2768	18.6

SUBSTATION	CKT	Primary Voltage (kV)	2014						Existing Feeder			Existing Feeder Level			2016 Short Term			2016 Feeder Level Remaining DG kW to 150% Gross DML
			Total DG (kW) on Primary -	Existing Primary Load (kVA)	Existing Primary Load (kW)	Existing Primary Peak Load (kVA)	Existing 50% Backbone Capacity (kVA)	Existing 50% Backbone Feeder Rating (kW)	Remaining DG to 50% Backbone Feeder Rating	Remaining DG kW to 100% Gross	Remaining DG kW to 120% Gross	Remaining DG kW to 150% Gross	2016 Primary Min Load (kVA)	2016 Primary Peak Load (kVA)	2016 Remaining Backbone Feeder Rating (kW)			
TSF-H145	H145-2	12.47	344.1	1,343.2	3,358.0	3456	4455	4455	999.1	1,267.7	1670.7	466.6	1,378	3,444	4367	1599.8		
TSF-H146	H146-1	12.47	109.5	1,598.8	3,997.0	3456	4945	4945	1489.3	1809.1	2288.7	287.4	1,640	4,099	4808	2172.1		
TSF-H146	H146-2	12.47	659.7	1,054.4	2,636.0	3456	3850	3850	394.7	605.6	921.9	742.9	1,081	2,703	3794	879.2		
TSF-H147	H147-1	12.47	114.9	1,222.8	3,057.0	3542	4650	4650	1107.9	1352.5	1719.3	129.4	1,254	3,135	4667	1751.7		
TSF-H147	H147-2	12.47	846.4	1,287.2	3,218.0	3542	3983	3983	440.8	698.2	1084.4	1,045.8	1,320	3,300	3817	934.4		
TSF-H148	H148-1	12.47	536.5	702.4	1,756.0	5562	5728	5728	165.9	306.4	517.1	604.1	720	1,801	5678	476.4		
TSF-H148	H148-2	12.47	1,720.8	1,057.6	2,644.0	5421	4758	4758	-663.2	-451.7	-134.4	1,937.8	1,085	2,712	4568	-310.8		
TSF-H149	H149-1	12.47	1,562.6	990.8	2,477.0	4968	4396	4396	571.8	373.6	76.4	1,759.6	1,016	2,540	4224	-235.4		
TSF-H149	H149-2	12.47	1,461.3	1,420.4	3,551.0	4968	4927	4927	-40.9	243.2	669.3	1,645.5	1,457	3,642	4779	539.6		
TSF-H150	H150-1	12.47	1,131.7	1,556.4	3,891.0	5562	5986	5986	424.7	736.0	1202.9	1,354.3	1,596	3,991	5804	1040.0		
TSF-H150	H150-2	12.47	2,718.5	2,167.6	5,419.0	5562	5011	5011	-550.9	-117.4	532.9	3,660.5	2,223	5,558	4124	-325.9		
TSF-H151	H151-1	4.16	218.1	142.8	357.0	883	807	807	-75.3	-46.7	-3.9	262.7	146	366	766	-43.0		
TSF-H151	H151-2	4.16	542.6	481.2	1,203.0	883	821	821	-61.4	34.8	179.2	682.1	494	1,234	694	581		
TSF-H152	H152-1	4.16	420.7	353.6	884.0	1311	1244	1244	-67.1	3.6	109.7	514.2	363	907	1160	29.7		
TSF-H152	H152-2	4.16	736.7	1,434.0	3,585.0	872	1569	1569	697.3	984.1	1414.3	829.5	1,471	3,677	1513	1376.5		
TSF-H153	H153-1	12.47	1,597.7	1,306.8	3,267.0	5562	5271	5271	-290.9	-29.5	362.5	1,799.1	1,340	3,351	5103	211.2		
TSF-H153	H153-2	12.47	579.4	248.8	622.0	5562	5231	5231	-330.6	-280.8	-206.2	723.7	255	638	5093	-340.9		
TSF-H154	H154-1	11.5	586.0	2,221.6	5,554.0	5000	6635	6635	1635.6	2080.0	2746.4	659.8	2,278	5,696	6618	2757.8		
TSF-H155	H155-1	11.5	288.2	1,429.2	3,573.0	3187	4348	4348	1161.0	1446.8	1875.6	302.0	1,466	3,664	4351	1896.6		
TSF-H155	H155-2	11.5	892.3	1,981.6	4,954.0	5129	6218	6218	1089.3	1485.6	2080.1	1,004.8	2,032	5,081	6156	2043.6		
TSF-H156	H156-1	11.5	159.5	1,701.2	4,253.0	3187	4729	4729	1541.7	1882.0	2392.3	251.3	1,745	4,362	4680	2365.7		
TSF-H156	H156-2	11.5	908.2	1,190.8	2,977.0	3536	3818	3818	282.6	520.7	878.0	1,051.4	1,221	3,053	3705	780.5		
TSF-H157	H157-1	4.16	72.0	211.6	529.0	793	932	932	139.6	182.0	245.4	172.9	217	543	837	152.6		
TSF-H157	H157-2	4.16	64.9	260.4	651.0	1099	1294	1294	195.5	247.5	325.7	73.1	267	668	1293	327.5		
TSF-H157	H157-3	4.16	23.6	100.8	252.0	1099	1176	1176	77.2	97.4	127.6	38.7	103	258	1163	116.4		
TSF-H158	H158-1	12.47	1,576.4	1,445.2	3,613.0	4730	4599	4599	-131.2	157.9	591.4	1,775.1	1,482	3,705	4437	448.1		
TSF-H158	H158-2	12.47	4,428.1	3,251.2	8,128.0	4568	3391	3391	-1176.9	-526.7	448.7	4,986.4	3,334	8,336	2916	15.1		
TSF-H159	H159-1	12.47	526.4	466.0	1,165.0	4730	4670	4670	-60.4	32.8	172.6	592.7	478	1,195	4615	124.2		
TSF-H159	H159-2	12.47	4,018.3	2,070.4	5,176.0	4730	2782	2782	-1947.9	-1533.8	-912.7	4,524.9	2,123	5,308	2329	-1339.9		
TSF-H160	H160-1	12.47	2,443.6	1,901.2	4,753.0	4730	4188	4188	-542.4	-162.2	408.2	2,751.7	1,950	4,875	3928	173.0		
TSF-H160	H160-2	12.47	701.4	432.0	1,080.0	4730	4461	4461	-269.4	-183.0	-53.4	855.7	443	1,108	4317	-191.1		
TSF-H161	H161-1	12.47	2,630.7	1,618.4	4,046.0	4568	3556	3556	-1012.3	-688.6	-203.1	2,962.4	1,660	4,149	3266	-472.7		
TSF-H161	H161-2	12.47	40.4	445.2	1,113.0	4568	4973	4973	404.8	493.9	627.4	45.5	457	1,141	4979	639.4		
TSF-H162	H162-1	12.47	603.4	1,697.6	4,244.0	4385	5479	5479	1094.2	1433.8	1943.0	797.4	1,741	4,353	5328	1814.1		
TSF-H162	H162-2	12.47	346.1	1,604.8	4,012.0	4385	5643	5643	1258.7	1579.7	2061.1	511.4	1,646	4,115	5519	1957.4		
TSF-H163	H163-1	12.47	341.5	1,705.2	4,263.0	4385	5748	5748	1363.7	1704.7	2216.3	384.6	1,749	4,372	5749	2238.6		
TSF-H164	H164-1	12.47	1,113.3	1,461.6	3,654.0	4385	4733	4733	348.3	640.6	1079.1	1,287.8	1,499	3,747	4596	960.7		
TSF-H164	H164-2	12.47	1,589.0	2,289.6	5,724.0	4385	5085	5085	700.6	1158.5	1845.4	1,912.8	2,348	5,870	4820	1609.5		
TSF-H165	H165-1	11.5	179.0	800.0	2,000.0	4983	4983	4983	621.0	781.0	1021.0	398.0	820	2,051	4785	832.7		
TSF-H165	H165-2	11.5	682.0	1,181.6	2,954.0	4213	4712	4712	499.6	735.9	1090.4	768.0	1,212	3,030	4657	1049.8		
TSF-H166	H166-1	11.5	1,884.2	1,745.2	4,363.0	4213	4074	4074	-139.0	210.1	733.6	2,121.7	1,790	4,475	3881	563.0		

SUBSTATION	CKT	Primary Voltage (kV)	2020 Short Term				2020 Feeder Level				2030 Long Term				2030 Feeder Level Remaining DG kW to 150% Gross DML
			Total DG kW on Primary - 2020 Mid Term	2020 Primary Min Load (kVA)	2020 Primary Peak Load (kVA)	Remaining DG to 50% Backbone Feeder Rating (kW)	Total DG kW on Primary - 2020 Mid Term	2020 Primary Min Load (kVA)	2020 Primary Peak Load (kVA)	Remaining DG to 50% Backbone Feeder Rating (kW)	Total DG kW on Primary - 2030 Long Term	2030 Primary Min Load (kVA)	2030 Primary Peak Load (kVA)	Remaining DG to 50% Backbone Feeder Rating (kW)	
TSF-H145	H145-2	12.47	605.9	1,418	3,544	4267	1520.5	873.2	1,068	2,669	3650	728.4			
TSF-H146	H146-1	12.47	1,687	4,218	4,770	4189	2157.8	537.9	1,271	3,177	4189	1368.4			
TSF-H146	H146-2	12.47	964.8	1,113	2,782	3604	704.4	1,390.3	838	2,095	2904	-133.2			
TSF-H147	H147-1	12.47	168.0	1,291	3,226	4665	1767.8	242.2	972	2,430	4272	1215.8			
TSF-H147	H147-2	12.47	1,358.2	1,359	3,396	3543	679.6	1,957.2	1,023	2,558	2608	-422.5			
TSF-H148	H148-1	12.47	784.6	741	1,853	5518	327.4	1,130.6	558	1,396	4989	-293.1			
TSF-H148	H148-2	12.47	2,516.6	1,116	2,791	4021	-842.3	3,626.6	841	2,102	2635	-2365.6			
TSF-H149	H149-1	12.47	2,285.2	1,046	2,614	3728	-716.6	3,293.1	788	1,969	2462	-2111.8			
TSF-H149	H149-2	12.47	2,137.0	1,499	3,748	4330	111.6	3,079.6	1,129	2,823	3017	-1386.0			
TSF-H150	H150-1	12.47	1,758.8	1,643	4,107	5445	705.2	2,534.6	1,237	3,093	4264	-678.8			
TSF-H150	H150-2	12.47	4,753.9	2,288	5,719	3095	-1322.3	6,850.7	1,723	4,307	434	-4266.3			
TSF-H151	H151-1	4.16	341.1	151	377	692	-115.0	491.6	114	284	505	-321.3			
TSF-H151	H151-2	4.16	885.9	508	1,270	505	-124.1	1,276.6	382	956	-11	-702.9			
TSF-H152	H152-1	4.16	667.8	373	933	1017	-108.1	962.4	281	703	630	-540.8			
TSF-H152	H152-2	4.16	1,077.3	1,513	3,784	1308	1192.9	1,552.5	1,140	2,850	459	157.3			
TSF-H153	H153-1	12.47	2,336.5	1,379	3,448	4604	-267.7	3,367.1	1,039	2,597	3233	-1808.9			
TSF-H153	H153-2	12.47	939.8	263	656	4884	-546.0	1,354.4	198	494	4405	-1057.7			
TSF-H154	H154-1	11.5	857.0	2,345	5,862	6487	2660.1	1,234.9	1,766	4,415	5531	1413.9			
TSF-H155	H155-1	11.5	392.2	1,508	3,771	4303	1870.4	565.2	1,136	2,840	3758	1138.9			
TSF-H155	H155-2	11.5	1,305.0	2,091	5,229	5915	1832.1	1,880.6	1,575	3,938	4824	482.1			
TSF-H156	H156-1	11.5	326.4	1,795	4,489	4656	2366.8	470.4	1,352	3,381	4069	1558.0			
TSF-H156	H156-2	11.5	1,365.4	1,257	3,142	3427	519.8	1,967.7	947	2,366	2514	-547.8			
TSF-H157	H157-1	4.16	224.6	223	558	791	110.4	323.6	168	420	637	-71.3			
TSF-H157	H157-2	4.16	95.0	275	687	1279	317.3	136.9	207	517	1169	173.6			
TSF-H157	H157-3	4.16	50.3	106	266	1155	109.3	72.5	80	200	1106	47.7			
TSF-H158	H158-1	12.47	2,305.4	1,525	3,813	3950	-17.4	3,322.2	1,149	2,872	2557	-1599.1			
TSF-H158	H158-2	12.47	6,075.9	3,431	8,578	1524	-1328.9	9,332.3	2,584	6,461	-2180	-5455.8			
TSF-H159	H159-1	12.47	769.8	492	1,230	4452	-32.0	1,109.3	370	926	3991	-553.7			
TSF-H159	H159-2	12.47	5,676.5	2,185	5,463	1039	-2598.8	8,468.5	1,646	4,114	-2093	-5999.9			
TSF-H160	H160-1	12.47	3,573.6	2,007	5,016	3163	-563.8	5,149.9	1,511	3,778	1091	-2883.0			
TSF-H160	H160-2	12.47	1,111.3	456	1,140	4075	-427.4	1,601.5	343	858	3472	-1086.4			
TSF-H161	H161-1	12.47	3,847.3	1,708	4,270	2429	-1285.2	5,544.2	1,286	3,216	310	-3614.5			
TSF-H161	H161-2	12.47	59.1	470	1,175	4979	645.7	85.1	354	885	4837	445.7			
TSF-H162	H162-1	12.47	1,035.6	1,792	4,479	5141	1651.9	1,492.3	1,349	3,373	4242	531.7			
TSF-H162	H162-2	12.47	664.2	1,694	4,234	5414	1876.4	957.1	1,276	3,189	4703	956.3			
TSF-H163	H163-1	12.47	499.5	1,800	4,499	5685	2200.1	719.8	1,355	3,389	5020	1313.4			
TSF-H164	H164-1	12.47	1,672.4	1,543	3,856	4255	641.5	2,410.1	1,162	2,905	3136	-667.4			
TSF-H164	H164-2	12.47	2,484.1	2,416	6,041	4317	1140.6	3,579.8	1,820	4,550	2625	-849.9			
TSF-H165	H165-1	11.5	516.8	844	2,111	4690	749.7	744.8	636	1,590	4253	209.0			
TSF-H165	H165-2	11.5	997.4	1,247	3,118	4462	873.2	1,437.3	939	2,348	3715	-28.4			
TSF-H166	H166-1	11.5	2,755.5	1,842	4,605	3299	7.4	3,970.9	1,387	3,468	1629	-1890.0			

SUBSTATION	CKT	Primary Voltage (kV)	Existing										2016 Short					2016 Feeder Level Remaining DG kW to 150% Gross DML
			Total DG (kW) on Primary - 2014	Existing Primary Load (kVA)	Existing Primary Min Load (kVA)	Existing Primary Peak Load (kVA)	Existing 50% Backbone Capacity (kVA)	Existing 50% Backbone Feeder Rating (kW)	Existing DG to 100% Gross DML	Existing Remaining DG kW to 120% Gross DML	Existing Feeder Level Remaining DG kW to 150% Gross DML	Total DG kW on Primary - 2016 Short Term	2016 Primary Min Load (kVA)	2016 Primary Peak Load (kVA)	Remaining DG to 50% Backbone Feeder Rating (kW)			
TSF-H166	H166-2	11.5	661.8	1,296.4	3,241.0	4213	4847	634.6	893.9	1282.8	745.2	1,330	3,324	4797	1249.1			
TSF-H167	H167-1	4.16	550.1	392.4	981.0	1117	959	-157.7	-79.3	38.5	710.8	402	1,006	808	-107.2			
TSF-H168	H168-1	4.16	802.3	574.4	1,436.0	1200	972	-227.9	-113.0	59.3	932.2	589	1,473	857	-48.6			
TSF-H169	H169-1	11.5	1,006.8	1,390.4	3,476.0	3436	3820	383.6	661.7	1078.8	1,133.7	1,426	3,565	3728	1005.2			
TSF-H170	H170-1	11.5	265.2	977.6	2,444.0	2440	3152	712.4	908.0	1201.2	355.1	1,003	2,507	3088	1148.8			
TSF-H170-2	H170-2	11.5	752.1	1,406.8	3,517.0	4780	5435	654.7	936.0	1358.1	954.5	1,443	3,607	5269	1209.7			
TSF-H171	H171-1	12.47	2,034.7	1,691.2	4,228.0	5108	4765	-343.5	-5.2	502.1	2,291.2	1,734	4,336	4551	310.5			
TSF-H171-2	H171-2	12.47	679.5	1,126.4	2,816.0	5108	5555	446.9	672.2	1010.1	765.1	1,155	2,888	5498	967.7			
TSF-H172	H172-1	12.47	710.1	2,882.0	7,205.0	4903	7075	2171.9	2748.3	3612.9	998.2	2,956	7,389	6860	3435.4			
TSF-H172	H172-2	12.47	1,343.2	1,235.2	3,088.0	4903	4795	-108.0	139.1	509.6	1,512.5	1,267	3,167	4657	387.7			
TSF-H173	H173-1	12.47	1,311.4	1,526.8	3,817.0	5108	5324	215.4	520.8	978.8	1,476.7	1,566	3,915	5197	872.1			
TSF-H173-2	H173-2	12.47	561.0	776.4	1,941.0	3348	3563	215.4	370.7	603.6	657.2	796	1,991	3487	537.2			
TSF-H174	H174-1	12.47	148.0	483.6	1,209.0	4903	5238	335.6	432.3	577.4	313.1	496	1,240	5086	430.9			
TSF-H174-2	H174-2	12.47	1,388.2	1,810.0	4,525.0	5108	5530	421.8	783.8	1326.8	1,563.3	1,856	4,641	5401	1221.2			
TSF-H175	H175-1	12.47	43.7	1,172.8	2,932.0	3834	4963	1129.1	1363.6	1715.5	49.9	1,203	3,007	4987	1754.3			
TSF-H176	H176-1	12.47	30.5	1,764.0	4,410.0	3834	5567	1733.5	2086.3	2615.5	34.4	1,809	4,523	5609	2679.3			
TSF-H176-2	H176-2	12.47	27.3	1,102.8	2,757.0	3834	4909	1075.5	1296.1	1626.9	30.7	1,131	2,828	4934	1665.8			
TSF-H177	H177-1	12.47	58.6	1,176.4	2,941.0	3834	4952	1117.8	1353.1	1706.0	66.0	1,206	3,016	4974	1743.7			
TSF-H178	H178-1	12.47	628.9	1,092.8	2,732.0	5583	6047	463.9	682.4	1010.3	708.2	1,121	2,802	5996	972.9			
TSF-H178-2	H178-2	12.47	2,921.3	2,038.0	5,095.0	5562	4678	-83.3	-475.7	135.7	3,288.7	2,090	5,225	4362	-154.5			
TSF-H179	H179-1	11.5	763.9	1,587.2	3,968.0	4362	5185	823.3	1140.7	1616.9	860.3	1,628	4,069	5130	1581.4			
TSF-H179-2	H179-2	11.5	1,325.5	1,626.8	4,067.0	4213	4514	301.3	626.7	1114.7	1,492.6	1,668	4,171	4889	1010.0			
TSF-H180	H180-1	11.5	2,983.6	1,698.4	4,246.0	4362	3077	-1285.2	-945.5	-436.0	3,483.1	1,742	4,355	2621	-870.3			
TSF-H180-2	H180-2	11.5	1,145.5	1,452.8	3,632.0	4362	4670	307.3	597.9	1033.7	1,289.9	1,490	3,725	4562	945.1			
TSF-H181	H181-1	12.47	398.3	1,345.6	3,364.0	5562	6509	947.3	1216.4	1620.1	489.2	1,380	3,450	6453	1580.9			
TSF-H182	H182-1	12.47	2,010.7	2,349.6	5,874.0	5562	5901	338.9	808.8	1513.7	2,325.6	2,410	6,024	5646	1288.9			
TSF-H183	H183-1	11.5	957.3	508.0	1,270.0	3794	3345	-449.3	-347.7	-195.3	1,078.0	521	1,302	3237	-296.5			
TSF-H183-2	H183-2	11.5	2,169.4	1,723.6	4,309.0	3794	3349	-445.8	-101.1	416.0	2,443.0	1,768	4,419	3119	208.6			
TSF-H184	H184-1	11.5	1,017.4	684.0	1,710.0	3794	3461	-333.4	-196.6	8.6	1,259.9	701	1,754	3236	-207.6			
TSF-H184-2	H184-2	11.5	973.7	1,344.8	3,362.0	3794	4166	371.1	640.1	1043.5	1,096.5	1,379	3,448	4077	972.3			
TSF-H185	H185-1	11.5	1,922.2	1,078.8	2,697.0	3794	2951	-843.4	-627.7	-304.0	2,206.0	1,106	2,766	2695	-546.4			
TSF-H185-2	H185-2	11.5	1,189.8	1,573.6	3,934.0	3794	4178	383.8	698.5	1170.6	1,339.8	1,614	4,035	4068	1080.9			
TSF-H186	H186-1	12.47	210.2	838.8	2,097.0	5421	6050	628.6	796.3	1048.0	338.4	860	2,151	5943	951.9			
TSF-H186-2	H186-2	12.47	667.7	1,219.2	3,048.0	5421	5973	551.5	795.4	1161.1	1,023.1	1,250	3,126	5649	852.4			
TSF-H187	H187-1	12.47	760.9	1,261.2	3,153.0	4730	5230	500.3	752.5	1130.9	1,015.4	1,293	3,234	5008	924.8			
TSF-H187-2	H187-2	12.47	2,367.6	2,084.0	5,210.0	4730	4447	-233.6	133.2	758.4	2,666.1	2,137	5,343	4201	539.9			
TSF-H188	H188-1	12.47	1,848.2	1,618.8	4,047.0	4730	4501	-229.4	94.4	580.0	2,081.2	1,660	4,151	4309	409.1			
TSF-H188-2	H188-2	12.47	647.8	1,284.8	3,212.0	4730	5367	637.0	893.9	1279.4	770.7	1,318	3,294	5277	1205.8			
TSF-H189	H189-1	12.47	773.5	1,111.2	2,778.0	5421	5759	337.7	559.9	893.3	871.1	1,140	2,849	5690	838.4			
TSF-H190	H190-1	12.47	478.3	1,111.2	2,778.0	5421	6054	632.9	855.2	1188.5	680.0	1,140	2,849	5881	1029.4			
TSF-H191	H191-1	12.47	294.9	411.2	1,028.0	4568	4684	116.3	198.6	321.9	332.0	422	1,054	4658	300.5			

SUBSTATION	CKT	Primary Voltage (kV)	2020 Short Term				2020 Feeder Level				2030 Long Term				2030 Feeder Level Remaining DG kW to 150% Gross DML
			Total DG kW on Primary - 2020 Mid Term	2020 Primary Min Load (kVA)	2020 Primary Peak Load (kVA)	Remaining DG to 50% Backbone Feeder Rating (kW)	Total DG kW on Primary - 2020 Mid Term	2020 Primary Min Load (kVA)	2020 Primary Peak Load (kVA)	Remaining DG to 50% Backbone Feeder Rating (kW)	Total DG kW on Primary - 2030 Long Term	2030 Primary Min Load (kVA)	2030 Primary Peak Load (kVA)	Remaining DG to 50% Backbone Feeder Rating (kW)	
TSF-H166	H166-2	11.5	967.8	1,368	3,421	4613	1084.6	1,394.6	1,030	2,576	3849	151.1			
TSF-H167	H167-1	4.16	923.2	414	1,035	608	-302.0	1,330.4	312	780	98	-862.5			
TSF-H168	H168-1	4.16	1,210.7	606	1,516	595	-301.4	1,744.7	457	1,141	-88	-1,059.8			
TSF-H169	H169-1	11.5	1,472.3	1,467	3,669	3431	728.8	2,121.7	1,105	2,763	2419	-463.9			
TSF-H170	H170-1	11.5	461.2	1,032	2,579	3011	1086.5	664.6	777	1,943	2553	501.1			
TSF-H170	H170-2	11.5	1,239.6	1,485	3,712	5026	987.6	1,786.3	1,118	2,796	4112	-109.0			
TSF-H171	H171-1	12.47	2,575.6	1,785	4,462	3917	-298.3	4,288.1	1,344	3,361	2164	-2271.6			
TSF-H171	H171-2	12.47	993.7	1,189	2,972	5303	789.6	1,432.0	895	2,238	4571	-88.9			
TSF-H172	H172-1	12.47	1,296.4	3,042	7,604	6648	3266.2	1,868.2	2,291	5,727	5326	1568.1			
TSF-H172	H172-2	12.47	1,964.3	1,304	3,259	4242	-8.9	2,830.8	982	2,455	3054	-1358.0			
TSF-H173	H173-1	12.47	1,917.8	1,611	4,029	4802	499.3	2,763.7	1,214	3,034	3558	-943.3			
TSF-H173	H173-2	12.47	853.5	819	2,049	3314	375.6	1,229.9	617	1,543	2735	-304.2			
TSF-H174	H174-1	12.47	406.6	510	1,276	5007	359.0	585.9	384	961	4701	-9.3			
TSF-H174	H174-2	12.47	2,030.2	1,910	4,776	4988	835.2	2,925.7	1,439	3,597	3621	-767.6			
TSF-H175	H175-1	12.47	64.8	1,238	3,094	5007	1791.8	93.4	932	2,331	4673	1304.9			
TSF-H176	H176-1	12.47	44.6	1,862	4,654	5651	2748.0	64.3	1,402	3,505	5172	2038.9			
TSF-H176	H176-2	12.47	39.9	1,164	2,910	4958	1706.0	57.5	877	2,191	4653	1257.4			
TSF-H177	H177-1	12.47	85.7	1,242	3,104	4990	1776.7	123.5	935	2,338	4645	1279.2			
TSF-H178	H178-1	12.47	919.8	1,153	2,883	5817	810.3	1,325.4	869	2,172	5126	-22.5			
TSF-H178	H178-2	12.47	4,272.3	2,151	5,377	3440	-1045.9	6,156.7	1,620	4,050	1025	-3726.5			
TSF-H179	H179-1	11.5	1,117.2	1,675	4,188	4920	1395.5	1,610.0	1,262	3,154	4014	282.5			
TSF-H179	H179-2	11.5	1,938.4	1,717	4,292	3991	637.0	2,793.4	1,293	3,233	2712	-853.7			
TSF-H180	H180-1	11.5	4,523.5	1,793	4,481	1631	-1834.7	6,518.7	1,350	3,375	806	-4493.6			
TSF-H180	H180-2	11.5	1,675.2	1,533	3,833	4220	624.8	2,414.1	1,155	2,887	3103	-681.8			
TSF-H181	H181-1	12.47	635.3	1,420	3,550	6347	1495.0	915.5	1,070	2,674	5716	688.9			
TSF-H182	H182-1	12.47	3,020.3	2,480	6,199	5021	699.4	4,352.4	1,868	4,669	3077	-1550.9			
TSF-H183	H183-1	11.5	1,400.1	536	1,340	2931	-595.8	2,017.6	404	1,010	2181	-1411.9			
TSF-H183	H183-2	11.5	3,172.7	1,819	4,548	2441	-444.0	4,572.1	1,370	3,425	592	-2517.0			
TSF-H184	H184-1	11.5	1,656.2	722	1,805	2880	-553.3	2,357.9	544	1,359	1980	-1542.3			
TSF-H184	H184-2	11.5	1,424.0	1,419	3,548	3790	705.0	2,052.1	1,069	2,672	2811	-448.6			
TSF-H185	H185-1	11.5	2,864.9	1,139	2,846	2068	-1157.0	4,128.5	858	2,144	523	-2842.2			
TSF-H185	H185-2	11.5	1,740.1	1,661	4,152	3715	751.1	2,507.6	1,251	3,127	2538	-631.3			
TSF-H186	H186-1	12.47	439.5	885	2,213	5867	888.4	633.4	667	1,667	5455	366.7			
TSF-H186	H186-2	12.47	1,328.8	1,287	3,217	5379	601.4	1,914.9	969	2,423	4476	-461.2			
TSF-H187	H187-1	12.47	1,318.7	1,331	3,328	4743	677.9	1,900.3	1,003	2,506	3832	-396.6			
TSF-H187	H187-2	12.47	3,462.5	2,199	5,499	3467	-163.2	4,989.7	1,657	4,141	1397	-2504.9			
TSF-H188	H188-1	12.47	2,702.9	1,709	4,271	3736	-140.1	3,895.1	1,287	3,217	2122	-1964.9			
TSF-H188	H188-2	12.47	1,000.9	1,356	3,390	5085	1033.1	1,442.4	1,021	2,553	4309	89.5			
TSF-H189	H189-1	12.47	1,131.3	1,173	2,932	5463	627.9	1,630.2	883	2,208	4674	-305.3			
TSF-H190	H190-1	12.47	883.1	1,173	2,932	5711	876.0	1,272.7	883	2,208	5032	52.3			
TSF-H191	H191-1	12.47	431.2	434	1,085	4571	219.7	621.4	327	817	4274	-131.2			

SUBSTATION	CKT	Primary Voltage (kV)	Existing										2016 Short Term			
			Total DG (kW) on Primary - 2014	Existing Primary Load (kW)	Existing Primary Peak Load (kW)	Existing 50% Backbone Capacity (kVA)	Remaining 50% Backbone Feeder Rating (kW)	Existing Feeder Level Remaining DG kW to 100% Gross DML	Existing Feeder Level Remaining DG kW to 120% Gross DML	Existing Feeder Level Remaining DG kW to 150% Gross DML	Total DG kW on Primary - 2016 Short Term	2016 Primary Min Load (kVA)	2016 Primary Peak Load (kVA)	Remaining DG to 50% Backbone Feeder Rating (kW)	2016 Feeder Level Remaining DG kW to 150% Gross DML	
TSF-H192	H192-1	12.47	868.5	1,391.2	3,478.0	4568	5091	527.7	800.9	1218.3	978.0	1,427	3,567	5017	1162.2	
TSF-H192	H192-2	12.47	765.7	1,166.0	2,915.0	4568	4968	400.3	633.5	983.3	862.3	1,196	2,990	4902	931.5	
TSF-H193	H193-1	12.47	1,079.2	622.4	1,556.0	5562	5105	-456.8	-332.3	-145.6	1,215.3	638	1,596	4985	-257.8	
TSF-H193	H193-2	12.47	1,236.3	622.4	1,556.0	6134	5520	-613.9	-489.4	-302.7	1,404.6	638	1,596	5368	-447.2	
TSF-H194	H194-1	4.16	101.3	45.2	113.0	1441	1385	-56.1	-47.1	-33.5	114.1	46	116	1373	-44.5	
TSF-H194	H194-2	4.16	730.6	606.0	1,515.0	1441	1316	-124.6	-3.4	178.4	836.4	621	1,554	1226	95.8	
TSF-H195	H195-1	4.16	660.6	386.0	965.0	958	684	-274.6	-197.4	-81.6	766.6	396	990	588	-172.8	
TSF-H195	H195-2	4.16	571.1	501.6	1,254.0	1117	1047	-69.5	30.9	181.3	643.1	514	1,286	988	128.6	
TSF-H196	H196-1	4.16	622.3	448.4	1,121.0	1657	1483	-173.9	-84.2	50.3	743.4	460	1,150	1374	-53.6	
TSF-H197	H197-1	4.16	451.9	359.6	899.0	883	790	-92.3	-20.4	87.5	605.0	369	922	646	-51.8	
Mau Electric																
TSF-M1	M1-1	12.47	958.9	1,338.0	2,570.3	3750	4129	379.1	646.7	1048.1	1,086.5	1,366	2,625	4030	963.0	
TSF-M1	M1-2	12.47	311.5	417.8	823.5	3750	3856	106.3	189.9	315.2	473.2	427	841	3703	166.8	
TSF-M2	M2-1	2.4	61.9	383.9	838.5	750	1072	322.0	398.7	513.9	113.6	392	856	1028	474.3	
TSF-M2	M2-2	2.4	8.2	201.4	459.4	750	943	193.2	233.5	293.9	17.3	206	469	938	291.1	
TSF-M2	M2-3	2.4	31.8	172.2	458.1	500	640	140.4	174.8	226.5	36.0	176	468	640	227.7	
TSF-M3	M3-1	2.4	92.7	116.1	51.3	84	42	23.4	46.6	81.4	146.2	119	52	-10	31.6	
TSF-M4	M4-1	12.47	177.1	1,699.6	4,124.1	6000	7523	1522.5	1862.5	2372.4	1,035.1	1,736	4,211	6701	1568.3	
TSF-M4	M4-2	12.47	929.6	1,772.1	3,709.1	6000	6842	842.4	1196.9	1728.5	1,925.5	1,810	3,788	5884	788.9	
TSF-M4	M4-3	4.16	414.6	409.2	1,133.5	1250	1245	-5.3	76.5	199.3	594.7	418	1,158	1073	32.1	
TSF-M4	M4-4	4.16	282.6	357.9	998.0	1250	1325	75.3	146.9	254.3	360.5	365	1,019	1255	187.7	
TSF-M4	M4-5	4.16	156.3	247.4	696.8	1250	1341	91.1	140.6	214.9	192.7	253	712	1310	186.3	
TSF-M5	M5-1	2.4	3.5	50.2	47.9	75	119	46.7	56.7	71.7	4.0	51	49	120	72.9	
TSF-M6	M6-1	2.4	77.2	387.0	387.0	0	310	309.8	387.2	503.3	87.5	395	395	308	505.3	
TSF-M7	M7-1	12.47	443.4	1,714.0	3,529.2	6250	7521	1270.6	1613.4	2127.6	2,715.7	1,750	3,604	5285	-90.3	
TSF-M7	M7-2	12.47	183.9	472.7	1,402.1	6250	6539	288.7	383.3	525.1	932.8	483	1,432	5800	-208.8	
TSF-M7	M7-3	12.47	920.8	1,702.7	3,475.3	6250	7032	781.9	1122.4	1633.2	1,243.5	1,739	3,549	6745	1364.6	
TSF-M7	M7-4	12.47	1,422.5	2,004.4	4,120.2	6250	6832	582.0	982.9	1584.2	1,611.8	2,047	4,207	6685	1458.5	
TSF-M7	M7-5	12.47	841.1	2,197.4	3,387.6	6250	7606	1356.4	1795.9	2455.1	1,308.6	2,244	3,459	7185	2057.4	
TSF-M7	M7-6	12.47	2,488.6	3,510.5	5,142.7	6250	7272	1021.8	1723.9	2777.1	3,957.5	3,585	5,252	5877	1419.8	
TSF-M8	M8-1	12.47	247.6	319.0	671.0	1250	1321	71.4	135.2	230.9	454.5	326	685	1121	34.1	
TSF-M9	M9-1	2.4	4.5	38.8	184.0	150	184	34.3	42.0	53.7	61.1	40	188	129	-1.6	
TSF-M10	M10-1	12.47	692.4	2,020.2	3,083.8	6000	7328	1327.8	1731.9	2338.0	1,071.5	2,063	3,149	6992	2023.0	
TSF-M10	M10-2	12.47	1,275.2	2,310.5	3,675.9	6000	7035	1035.3	1497.4	2190.5	1,622.8	2,359	3,754	6737	1916.4	
TSF-M10	M10-3	12.47	505.6	1,467.2	2,216.0	6000	6962	961.6	1255.1	1695.2	615.5	1,498	2,263	6883	1631.9	
TSF-M10	M10-4	12.47	2,613.3	4,048.3	5,936.8	6000	7435	1435.0	2244.6	3459.1	3,596.9	4,134	6,062	6537	2604.1	
TSF-M10	M10-5	12.47	1,776.8	2,093.9	4,183.8	6000	6317	317.1	735.9	1364.0	2,292.9	2,138	4,272	5845	914.5	
TSF-M10	M10-6	12.47	2,012.3	1,759.9	2,693.1	6000	5748	-252.4	99.6	627.6	2,907.0	1,797	2,750	4890	-211.2	
TSF-M11	M11-1	4.16	231.5	472.9	894.0	750	991	241.4	335.9	477.8	305.8	483	913	927	418.5	
TSF-M12	M12-1	12.47	1,447.7	2,064.0	4,097.7	3750	4366	616.3	1029.0	1648.2	1,907.7	2,108	4,185	3950	1253.8	
TSF-M12	M12-2	12.47	1,399.0	1,552.7	4,384.4	3750	3904	153.7	464.3	930.1	1,961.1	1,586	4,477	3374	417.3	

SUBSTATION	CKT	Primary Voltage (kV)	2020 Short Term					2030 Long Term				
			Total DG kW on Primary - 2020 Mid Term	2020 Primary Min Load (kVA)	2020 Primary Peak Load (kVA)	Remaining DG to 50% Backbone Feeder Rating (kW)	2020 Feeder Level Remaining DG kW to 150% Gross DML	Total DG kW on Primary - 2030 Long Term	2030 Primary Min Load (kVA)	2030 Primary Peak Load (kVA)	Remaining DG to 50% Backbone Feeder Rating (kW)	2030 Feeder Level Remaining DG kW to 150% Gross DML
TSF-H192	H192-1	12.47	1,270.1	1,468	3,671	4766	932.3	1,830.4	1,106	2,765	3844	-171.6
TSF-H192	H192-2	12.47	1,119.8	1,231	3,077	4679	726.1	1,613.7	927	2,317	3881	-223.5
TSF-H193	H193-1	12.47	1,578.3	657	1,642	4640	-593.0	2,274.5	495	1,237	3782	-1532.3
TSF-H193	H193-2	12.47	1,824.2	657	1,642	4967	-838.9	2,628.8	495	1,237	4000	-1886.7
TSF-H194	H194-1	4.16	148.2	48	119	1341	-76.6	213.5	36	90	1263	-159.6
TSF-H194	H194-2	4.16	1,086.3	640	1,599	994	-126.9	1,565.4	482	1,204	357	-842.8
TSF-H195	H195-1	4.16	995.6	407	1,018	370	-384.5	1,434.8	307	767	-170	-974.5
TSF-H195	H195-2	4.16	835.1	529	1,323	811	-41.0	1,203.5	399	997	312	-605.4
TSF-H196	H196-1	4.16	965.5	473	1,183	1165	-255.6	1,391.4	356	891	622	-856.7
TSF-H197	H197-1	4.16	785.7	380	949	477	-216.4	1,132.2	286	715	36	-703.4
Maui Electric												
TSF-M1	M1-1	12.47	1,305.2	1,487	2,857	3932	925.7	1,564.4	1,426	2,739	3611	574.2
TSF-M1	M1-2	12.47	568.5	464	915	3646	128.2	681.3	445	878	3514	-13.5
TSF-M2	M2-1	2.4	136.5	427	932	1040	503.5	163.6	409	894	995	449.9
TSF-M2	M2-2	2.4	20.8	224	511	953	315.0	25.0	215	490	940	296.9
TSF-M2	M2-3	2.4	43.3	191	509	648	243.8	51.9	183	488	632	223.3
TSF-M3	M3-1	2.4	175.6	129	57	-35	17.9	210.5	124	55	-72	-25.0
TSF-M4	M4-1	12.47	1,243.4	1,889	4,584	6646	1590.4	1,490.3	1,811	4,395	6321	1226.3
TSF-M4	M4-2	12.47	2,313.1	1,970	4,123	5657	641.5	2,772.4	1,888	3,952	5116	60.1
TSF-M4	M4-3	4.16	714.4	455	1,260	990	-32.1	856.3	436	1,208	830	-202.2
TSF-M4	M4-4	4.16	433.1	398	1,109	1215	163.6	519.1	381	1,063	1112	52.9
TSF-M4	M4-5	4.16	231.5	275	775	1293	181.0	277.5	264	743	1236	118.0
TSF-M5	M5-1	2.4	4.8	56	53	123	78.9	5.7	53	51	120	74.5
TSF-M6	M6-1	2.4	105.1	430	430	325	540.2	126.0	412	412	286	492.6
TSF-M7	M7-1	12.47	3,262.4	1,905	3,923	4893	-404.5	3,910.1	1,826	3,761	4166	-1170.5
TSF-M7	M7-2	12.47	1,120.6	525	1,559	5655	-325.5	1,343.0	504	1,494	5411	-587.6
TSF-M7	M7-3	12.47	1,493.8	1,893	3,863	6649	1345.1	1,790.4	1,814	3,703	6274	931.1
TSF-M7	M7-4	12.47	1,936.3	2,228	4,580	6542	1405.9	2,320.7	2,136	4,390	6065	883.2
TSF-M7	M7-5	12.47	1,572.0	2,443	3,766	7121	2091.9	1,884.1	2,342	3,610	6707	1628.3
TSF-M7	M7-6	12.47	4,754.1	3,902	5,716	5398	1099.1	5,698.1	3,741	5,480	4293	-86.9
TSF-M8	M8-1	12.47	546.0	355	746	1059	-14.1	654.5	340	715	935	-144.5
TSF-M9	M9-1	2.4	73.4	43	205	120	-8.7	87.9	41	196	103	-25.9
TSF-M10	M10-1	12.47	1,287.2	2,246	3,428	6958	2081.3	1,542.8	2,153	3,286	6610	1686.4
TSF-M10	M10-2	12.47	1,949.5	2,568	4,086	6619	1903.0	2,336.6	2,462	3,917	6126	1356.6
TSF-M10	M10-3	12.47	739.4	1,631	2,463	6891	1706.9	886.2	1,563	2,361	6677	1459.0
TSF-M10	M10-4	12.47	4,321.0	4,500	6,599	6179	2428.9	5,178.9	4,314	6,326	5135	1291.8
TSF-M10	M10-5	12.47	2,754.4	2,328	4,651	5573	736.8	3,301.3	2,231	4,458	4930	45.5
TSF-M10	M10-6	12.47	3,492.1	1,956	2,994	4464	-557.7	4,185.5	1,875	2,870	3690	-1372.5
TSF-M11	M11-1	4.16	367.4	526	994	908	421.1	440.3	504	953	814	315.5
TSF-M12	M12-1	12.47	2,291.8	2,294	4,555	3752	1149.6	2,746.8	2,199	4,367	3203	552.2
TSF-M12	M12-2	12.47	2,355.9	1,726	4,874	3120	233.0	2,823.7	1,655	4,672	2581	-341.8

SUBSTATION	CKT	Primary Voltage (kV)	2014										2016										2016 Short Term Remaining DG to 50% Backbone Feeder Rating (kW)	2016 Primary Peak Load (kVA)	2016 Primary Min Load (kVA)	2016 Primary Peak Load (kVA)	2016 Short Term Remaining DG to 50% Backbone Feeder Rating (kW)	2016 Feeder Level Remaining DG kW to 150% Gross DML
			Total DG on Primary - 2014 (kW)	Existing Primary Load (kVA)	Existing Primary Load (kVA)	Existing Primary Load (kVA)	Existing 50% Backbone Feeder Capacity (kVA)	Existing 50% Backbone Feeder Rating (kW)	Existing Remaining DG to 50% Backbone Feeder Rating (kW)	Existing Feeder Level Remaining DG kW to 100% Gross DML	Existing Feeder Level Remaining DG kW to 120% Gross DML	Existing Feeder Level Remaining DG kW to 150% Gross DML	Total DG on Primary - 2016 Term	2016 Primary Min Load (kVA)	2016 Primary Peak Load (kVA)	2016 Short Term Remaining DG to 50% Backbone Feeder Rating (kW)	2016 Feeder Level Remaining DG kW to 150% Gross DML											
TSF-M13	M13-1	12.47	1270	43.6	13.7	2575	2462	83.4	-74.7	-61.6	360.5	45	14	2228	-293.7													
TSF-M14	M14-1	12.47	464.2	2,558.8	4,518.6	3750	5845	2094.6	2606.3	3374.0	683.6	2,613	4,614	5679	3235.8													
TSF-M14	M14-2	12.47	745.8	903.7	2,004.7	3750	3908	157.9	338.6	609.7	1,419.2	923	2,047	3254	-34.9													
TSF-M14	M14-3	12.47	2210	847.5	1,597.8	3750	4377	626.5	796.0	1050.3	455.2	865	1,632	4160	843.1													
TSF-M14	M14-4	12.47	24.1	664.8	1,378.0	3750	4391	640.7	773.6	973.1	79.6	679	1,407	4349	938.8													
TSF-M14	M14-5	12.47	1,142.1	2,191.0	4,158.5	5000	6049	1048.9	1487.1	2144.4	1,703.4	2,237	4,247	5534	1652.7													
TSF-M14	M14-6	12.47	65.5	916.1	2,185.7	5000	5851	850.6	1033.8	1308.6	86.0	935	2,232	5850	1317.3													
TSF-M14	M14-7	12.47	1,037.2	2,481.5	4,296.6	5000	6444	1444.4	1940.7	2685.1	1,937.7	2,534	4,388	5596	1863.4													
TSF-M15	M15-1	12.47	1,608.5	2,494.2	4,975.8	3750	4636	885.7	1384.6	2132.8	2,412.1	2,547	5,081	3885	1408.5													
TSF-M15	M15-2	12.47	363.6	990.3	2,071.4	3750	4377	626.6	824.7	1121.8	502.1	1,011	2,115	4259	1014.7													
TSF-M16	M16-1	12.47	1,362.0	5,175.2	9,166.5	5000	6584	1583.8	2034.0	6400.7	1,651.8	5,285	9,361	8633	6275.4													
TSF-M16	M16-2	12.47	667.1	2,250.9	4,001.5	5000	5283	283.5	344.7	436.5	25.6	313	1,096	5287	443.2													
TSF-M16	M16-3	12.47	22.6	306.1	1,072.8	5000	5283	283.5	344.7	436.5	25.6	313	1,096	5287	443.2													
TSF-M17	M17-1	12.47	479.5	558.1	2,045.0	3750	3829	78.6	190.2	357.7	835.7	570	2,088	3484	19.2													
TSF-M17	M17-2	12.47	540.4	771.6	1,573.1	3750	3981	231.3	385.6	617.1	995.4	788	1,606	3543	186.6													
TSF-M17	M17-3	12.47	505.1	662.0	3,365.1	3750	3907	156.9	289.3	487.8	655.2	676	3,436	3771	358.8													
TSF-M18	M18-1	2.4	198.5	-	-	1875	1677	-198.5	-198.5	-198.5	758.8	-	-	1116	-758.8													
TSF-M19	M19-1	12.47	314.4	1,948.9	3,340.5	4688	6322	1634.5	2024.3	2608.9	356.3	1,990	3,411	6321	2629.0													
TSF-M20	M20-1	12.47	741.8	1,527.9	12,311.2	6000	6786	786.1	1091.7	1550.0	2,522.1	1,560	12,572	5038	-181.7													
TSF-M20	M20-2	12.47	294.8	1,578.3	3,075.8	6000	7283	1283.5	1599.1	2072.6	457.9	1,612	3,141	7154	1959.6													
TSF-M21	M21-1	69	-	-	-	0	0	0.0	0.0	0.0	-	-	-	0	0.0													
TSF-M22	M22-1	4.16	15.0	608.0	1,314.3	750	1343	593.1	714.7	897.1	132.5	621	1,342	1238	798.8													
TSF-M22	M22-2	4.16	196.5	201.7	538.5	750	755	5.1	45.5	106.0	231.3	206	550	725	77.6													
TSF-M23	M23-1	4.16	450.4	890.6	1,716.7	1250	1690	440.2	618.3	885.5	1,036.9	910	1,753	1123	327.4													
TSF-M24	M24-1	12.47	838.9	732.0	1,191.5	1250	1143	-106.8	39.6	259.2	1,126.9	748	1,217	871	-5.5													
TSF-M25	M25-1	12.47	1,596.8	1,737.1	4,272.1	5000	5140	140.2	487.6	1008.8	1,809.4	1,774	4,363	4964	851.4													
TSF-M25	M25-2	12.47	3.2	123.3	1,004.4	5000	5120	120.2	144.8	181.8	275.0	126	1,026	4851	-86.1													
TSF-M25	M25-3	12.47	1,806.4	2,092.6	4,717.3	4688	4974	286.2	704.8	1332.5	2,295.5	2,137	4,817	4529	909.9													
TSF-M25	M25-4	12.47	175.5	281.2	1,058.8	4688	4793	105.7	161.9	246.3	198.9	287	1,081	4776	231.9													
TSF-M26	M26-1	12.47	1,344.2	2,750.7	4,909.3	5000	6407	1406.5	1956.7	2781.9	1,578.7	2,809	5,013	6230	2634.8													
TSF-M26	M26-2	12.47	120.1	2,759.4	5,042.5	5000	7639	2639.3	3191.2	4019.0	136.1	2,818	5,149	7682	4090.6													
TSF-M26	M26-3	12.47	676.0	1,872.1	3,051.3	5000	6196	1196.0	1570.4	2132.0	1,498.8	1,912	3,116	5413	1368.7													
TSF-M26	M26-4	12.47	6.5	61.2	911.0	5000	5055	54.7	67.0	85.3	303.1	62	930	4759	-209.4													
TSF-M27	M27-1	4.16	391.1	374.4	748.4	500	483	-16.6	58.3	170.6	699.6	382	764	183	-126.1													
TSF-M28	M28-1	12.47	696.5	1,169.7	2,291.3	3750	4223	473.1	707.1	1058.0	1,490.6	1,194	2,340	3454	301.0													
TSF-M28	M28-2	12.47	1,255.0	991.4	2,852.1	3750	3486	-263.6	-65.3	232.1	1,901.8	1,012	2,913	2861	-383.1													
TSF-M29	M29-1	12.47	508.6	1,081.0	4,083.2	6000	6572	572.4	788.6	1112.9	744.7	1,104	4,170	6359	911.1													
TSF-M29	M29-2	12.47	166.9	315.3	1,094.1	6000	6148	148.4	211.4	306.0	189.1	322	1,117	6133	293.8													
TSF-M29	M29-3	12.47	2,388.8	2,344.8	3,350.7	6000	5956	-44.6	425.0	1128.4	3,563.8	2,395	3,422	4831	28.0													
TSF-M29	M29-4	12.47	487.0	1,806.0	2,626.4	6000	7319	1319.0	1680.2	2222.0	551.9	1,844	2,682	7292	2214.5													

SUBSTATION	CKT	Primary Voltage (kV)	2020 Short Term				2030 Long Term					
			Total DG kW on Primary - 2020 Mid Term	2020 Primary Min Load (kVA)	2020 Primary Peak Load (kVA)	Remaining DG to 50% Backbone Feeder Rating (kW)	Total DG kW on Primary - 2030 Long Term	2030 Primary Min Load (kVA)	2030 Primary Peak Load (kVA)	Remaining DG to 50% Backbone Feeder Rating (kW)		
TSF-M13	M13-1	12.47	433.1	48	15	2157	-360.4	519.1	46	15	2071	-449.4
TSF-M14	M14-1	12.47	821.2	2,844	5,023	5773	3445.1	984.3	2,727	4,815	5492	3105.6
TSF-M14	M14-2	12.47	1,704.9	1,005	2,228	3050	-198.1	2,043.4	963	2,136	2670	-598.9
TSF-M14	M14-3	12.47	546.8	942	1,776	4145	866.4	655.4	903	1,703	3998	699.3
TSF-M14	M14-4	12.47	95.6	739	1,532	4393	1012.9	114.6	708	1,468	4344	948.1
TSF-M14	M14-5	12.47	2,046.3	2,435	4,622	5389	1606.9	2,452.6	2,335	4,431	4882	1049.5
TSF-M14	M14-6	12.47	103.3	1,018	2,430	5915	1424.2	123.8	976	2,329	5852	1340.5
TSF-M14	M14-7	12.47	2,327.8	2,758	4,776	5431	1809.9	2,790.0	2,644	4,578	4854	1176.5
TSF-M15	M15-1	12.47	2,897.6	2,772	5,531	3625	1261.1	3,473.0	2,658	5,302	2935	513.8
TSF-M15	M15-2	12.47	603.2	1,101	2,302	4248	1047.9	722.9	1,055	2,207	4082	859.9
TSF-M16	M16-1	12.47	1,984.3	5,753	10,189	8768	6644.6	2,378.3	5,515	9,768	8136	5893.7
TSF-M16	M16-2	12.47	3,128.1	2,502	4,448	4374	624.9	3,749.3	2,399	4,264	3649	-151.4
TSF-M16	M16-3	12.47	30.8	340	1,192	5309	479.5	36.9	326	1,143	5289	452.3
TSF-M17	M17-1	12.47	1,003.9	620	2,273	3366	-73.3	1,203.3	595	2,179	3141	-311.1
TSF-M17	M17-2	12.47	1,195.7	858	1,749	3412	90.8	1,433.2	822	1,676	3139	-199.8
TSF-M17	M17-3	12.47	787.1	736	3,741	3699	316.6	943.4	705	3,586	3512	114.7
TSF-M18	M18-1	2.4	911.5	-	-	963	-911.5	1,092.5	-	-	782	-1092.5
TSF-M19	M19-1	12.47	428.0	2,166	3,713	6426	216.8	513.0	2,077	3,560	6251	207.8
TSF-M20	M20-1	12.47	3,029.8	1,698	13,685	4669	-482.2	3,631.4	1,628	13,119	3997	-1189.2
TSF-M20	M20-3	12.47	550.1	1,754	3,419	7204	2081.4	659.4	1,682	3,278	7022	1863.3
TSF-M21	M21-1	69	-	-	-	0	0.0	-	-	-	0	0.0
TSF-M22	M22-1	4.16	159.2	676	1,461	1267	854.6	190.8	648	1,400	1207	781.1
TSF-M22	M22-2	4.16	277.8	224	599	696	58.4	333.0	215	574	632	-10.7
TSF-M23	M23-1	4.16	1,245.6	990	1,908	994	239.4	1,492.9	949	1,829	706	-69.3
TSF-M24	M24-1	12.47	1,353.7	814	1,324	710	-133.1	1,622.5	780	1,270	408	-452.4
TSF-M25	M25-1	12.47	2,173.6	1,931	4,749	4757	722.7	2,605.2	1,851	4,552	4246	171.3
TSF-M25	M25-2	12.47	330.4	137	1,116	4807	-124.8	396.0	131	1,070	4735	-198.9
TSF-M25	M25-3	12.47	2,757.6	2,326	5,244	4256	731.5	3,305.2	2,230	5,027	3612	39.7
TSF-M25	M25-4	12.47	238.9	313	1,177	4761	230.0	286.3	300	1,128	4701	163.1
TSF-M26	M26-1	12.47	1,896.5	3,058	5,457	6161	2690.0	2,273.1	2,931	5,231	5658	2123.7
TSF-M26	M26-2	12.47	163.5	3,067	5,605	7904	4437.4	195.9	2,940	5,373	7744	4214.7
TSF-M26	M26-3	12.47	1,800.5	2,081	3,392	5280	1320.9	2,158.0	1,995	3,252	4837	834.3
TSF-M26	M26-4	12.47	364.1	68	1,013	4704	-262.1	436.5	65	971	4629	-338.7
TSF-M27	M27-1	4.16	840.5	416	832	76	-216.1	1,007.4	399	797	-108	-408.8
TSF-M28	M28-1	12.47	1,790.7	1,300	2,547	3259	159.6	2,146.2	1,246	2,442	2850	-276.6
TSF-M28	M28-2	12.47	2,284.6	1,102	3,170	2567	-631.5	2,738.2	1,056	3,039	2068	-1153.5
TSF-M29	M29-1	12.47	894.6	1,202	4,539	6307	907.8	1,072.2	1,152	4,351	6080	655.6
TSF-M29	M29-2	12.47	227.2	350	1,216	6123	298.5	272.3	336	1,166	6064	231.6
TSF-M29	M29-3	12.47	4,281.2	2,606	3,725	4325	-371.5	5,131.2	2,499	3,571	3367	-1383.2
TSF-M29	M29-4	12.47	662.9	2,008	2,919	7345	2348.3	794.6	1,924	2,799	7130	2092.1

SUBSTATION	CKT	Primary Voltage (kV)	Existing										2016 Short Term			
			Total DG (kW) on Primary - 2014	Existing Primary Min Load (kW)	Existing Primary Peak Load (kW)	Existing 50% Backbone Capacity (kVA)	Existing 50% Backbone Feeder Rating (kW)	Existing DG to 50% Backbone Feeder Rating (kW)	Existing Feeder Level Remaining DG kW to 100% Gross DML	Existing Feeder Level Remaining DG kW to 120% Gross DML	Existing Feeder Level Remaining DG kW to 150% Gross DML	Total DG kW on Primary - 2016 Short Term	2016 Primary Min Load (kVA)	2016 Primary Peak Load (kVA)	Remaining DG to 50% Backbone Feeder Rating (kW)	2016 Feeder Level Remaining DG kW to 150% Gross DML
TSF-M29	M29-5	12.47	143.1	87.7	2,400.0	750	695	55.4	-37.9	-11.6	162.2	90	2,451	677	-27.9	
TSF-M30	M30-1	12.47	-	-	-	1875	1875	0.0	0.0	0.0	-	-	-	1875	0.0	
TSF-M31	M31-1	12.47	835.5	1,814.7	3,536.9	6250	7229	979.3	1342.2	1886.6	1,121.7	1,853	3,612	6981	1658.0	
TSF-M31	M31-2	12.47	255.3	891.0	1,965.7	6250	6886	635.7	813.9	1081.2	441.2	910	2,007	6719	923.6	
TSF-M31	M31-3	12.47	660.6	2,303.5	4,821.1	6250	7893	1643.0	2103.7	2794.7	889.3	2,352	4,923	7713	2639.2	
TSF-M31	M31-4	12.47	-	1,401.4	2,404.5	6250	7651	1401.4	1681.7	2102.1	283.3	1,431	2,455	7398	1863.4	
TSF-M31	M31-5	12.47	145.4	1,519.7	2,780.2	6250	7624	1374.3	1678.2	2134.1	221.6	1,552	2,839	7580	2106.3	
TSF-M31	M31-6	12.47	175.5	1,230.8	2,308.4	6250	7305	1055.3	1301.4	1670.7	198.8	1,257	2,357	7308	1686.4	
TSF-M31	M31-7	12.47	1,101.4	1,142.2	1,771.5	6250	6291	40.9	269.3	612.0	1,527.8	1,166	1,809	5889	211.8	
TSF-M31	M31-8	12.47	478.1	2,803.6	4,473.1	6250	8576	2325.5	2886.2	3727.3	541.8	2,863	4,568	8571	3752.7	
TSF-M32	M32-1	12.47	584.7	880.4	2,069.0	4685	4981	295.7	471.8	735.9	2,118.7	899	2,113	3465	-770.2	
TSF-M32	M32-2	12.47	-	258.5	3,600.8	4685	4944	258.5	310.2	387.8	-	264	3,677	4949	396.0	
TSF-M32	M32-3	12.47	1,459.4	2,493.1	4,280.2	4685	5719	1033.7	1532.3	2280.3	1,800.8	2,546	4,371	5430	2018.1	
TSF-M32	M32-4	4.16	275.0	620.0	839.2	750	1095	345.0	469.0	655.1	749.4	633	857	634	200.3	
TSF-M32	M32-5	4.16	272.3	385.2	952.8	750	863	113.0	190.0	305.6	535.1	393	973	608	55.0	
TSF-M33	M33-1	12.47	358.5	711.7	1,339.1	1875	2228	353.2	495.5	709.0	422.4	727	1,367	2179	667.8	
TSF-M33	M33-2	4.16	291.3	600.6	1,154.8	1875	2184	309.3	429.5	609.7	348.6	613	1,179	2140	571.5	
TSF-M34	M34-1	2.4	48.3	86.5	61.9	125	139	38.2	55.5	81.5	64.4	88	63	124	68.1	
TSF-M35	M35-1	12.47	-	868.7	6,876.0	2500	3369	868.7	1042.5	1303.1	-	887	7,022	3387	1330.7	
TSF-M35	M35-2	12.47	152.1	261.0	666.0	2500	2609	108.9	161.1	239.4	172.3	267	680	2594	227.5	
TSF-M35	M35-3	12.47	223.5	298.0	2,168.0	2500	2575	74.5	134.1	223.4	253.2	304	2,214	2551	203.3	
TSF-M35	M35-4	12.47	842.3	751.0	1,301.0	2500	2409	-91.3	58.9	284.2	954.5	767	1,329	2312	195.9	
TSF-M35	M35-5	12.47	219.9	168.0	817.0	2500	2448	-51.9	-18.3	32.1	249.2	172	834	2422	8.1	
TSF-M36	M36-1	12.47	137.2	917.0	2,092.0	2500	3280	779.8	963.2	1238.3	156.9	936	2,136	3280	1247.8	
TSF-M36	M36-2	12.47	24.1	198.0	385.0	2500	2674	173.9	213.5	272.9	27.8	202	393	2674	275.4	
TSF-M36	M36-3	12.47	11.2	357.0	956.0	2500	2846	345.8	417.2	524.3	22.2	365	976	2842	524.7	
TSF-M37	M37-1	12.47	140.5	-	-	1500	4035	2535.2	3315.6	4486.2	240.6	3,985	23,114	5244	4205.3	
TSF-M37	M37-2	12.47	980.4	-	-	0	0	-	-	-	1,185.2	-	-	0	-	
TSF-M37	M37-3	12.47	245.9	3,902.0	22,635.0	0	0	-	-	-	345.8	-	-	0	-	
Hawaii Electric Light																
TSF-L1	L1-1	12.47	643.3	1,797.4	3,060.0	2496	3650	1154.1	1513.5	2052.8	792.8	1,780	3,031	3483	1877.8	
TSF-L1	L1-2	12.47	85.1	407.4	1,090.0	4685	5007	322.3	403.8	526.0	160.4	404	1,080	4928	445.0	
TSF-L2	L2-1	12.47	172.8	1,006.3	2,624.0	3423	4257	833.5	1034.7	1336.6	196.4	997	2,599	4224	1298.7	
TSF-L2	L2-2	12.47	19.8	956.4	2,270.0	2054	2991	936.6	1127.9	1414.8	75.5	947	2,249	2926	1345.5	
TSF-L3	L3-1	12.47	489.2	905.9	3,900.0	1289	1706	416.8	597.9	869.7	599.5	897	3,863	1587	746.5	
TSF-L3	L3-2	12.47	594.2	2,105.4	2,740.0	1022	2533	1511.2	1932.3	2563.9	752.5	2,085	2,714	2355	2375.7	
TSF-L4	L4-1	2.4	141.4	197.8	397.0	117	173	56.4	95.9	155.3	168.6	196	393	144	125.3	
TSF-L5	L5-1	2.4	146.8	532.0	883.0	290	676	385.2	491.6	651.2	197.4	527	875	620	598.1	
TSF-L6	L6-1	12.47	-	1,184.0	1,676.0	3233	3233	1184.0	1420.8	1776.0	113.7	1,173	1,660	3108	1645.5	
TSF-L7	L7-1	12.47	174.9	612.1	800.0	1250	1687	437.2	559.6	743.3	249.1	606	792	1607	660.3	
TSF-L8	L8-1	4.16	312.9	502.0	867.0	1084	1274	189.1	289.5	440.1	422.5	497	859	1159	323.3	

SUBSTATION	CKT	Primary Voltage (kV)	2020 Short Term				2030 Long Term					
			Total DG kW on Primary - 2020 Mid Term	2020 Primary Min Load (kVA)	2020 Primary Peak Load (kVA)	Remaining DG to 50% Backbone Feeder Rating (kW)	Total DG kW on Primary - 2030 Long Term	2030 Primary Min Load (kVA)	2030 Primary Peak Load (kVA)	Remaining DG to 50% Backbone Feeder Rating (kW)		
TSF-M29	M29-5	12.47	194.8	97	2,668	653	-48.6	233.5	93	2,557	610	-93.4
TSF-M30	M30-1	12.47	-	-	-	1875	0.0	-	-	-	1875	0.0
TSF-M31	M31-1	12.47	1,347.5	2,017	3,932	6920	1678.3	1,615.1	1,934	3,769	6569	1285.6
TSF-M31	M31-2	12.47	530.0	990	2,185	6710	955.6	635.2	949	2,095	6564	788.9
TSF-M31	M31-3	12.47	1,068.3	2,561	5,359	7742	272.5	1,280.4	2,455	5,137	7424	2401.6
TSF-M31	M31-4	12.47	340.3	1,558	2,673	7467	1996.4	407.9	1,493	2,562	7335	1832.2
TSF-M31	M31-5	12.47	266.1	1,689	3,090	7673	2267.7	319.0	1,619	2,963	7550	2110.1
TSF-M31	M31-6	12.47	238.9	1,368	2,566	7379	1813.3	286.3	1,312	2,460	7275	1681.0
TSF-M31	M31-7	12.47	1,835.3	1,270	1,969	5684	69.2	2,199.8	1,217	1,888	5267	-374.0
TSF-M31	M31-8	12.47	650.8	3,116	4,972	8716	4023.8	780.1	2,988	4,767	8458	3701.3
TSF-M32	M32-1	12.47	2,545.2	979	2,300	3118	-1077.3	3,050.6	938	2,205	2573	-1643.4
TSF-M32	M32-2	12.47	-	287	4,003	4972	431.1	-	275	3,837	4960	413.2
TSF-M32	M32-3	12.47	2,163.2	2,771	4,758	5293	1993.7	2,592.8	2,657	4,561	4749	1392.2
TSF-M32	M32-4	4.16	900.3	689	933	539	133.5	1,079.0	661	894	332	-88.0
TSF-M32	M32-5	4.16	642.8	428	1,059	535	-0.4	770.4	410	1,015	390	-154.6
TSF-M33	M33-1	4.16	507.4	791	1,489	2159	679.2	608.1	758	1,427	2025	529.4
TSF-M33	M33-2	4.16	418.8	668	1,284	2124	582.7	501.9	640	1,231	2013	458.2
TSF-M34	M34-1	2.4	77.4	96	69	116	66.8	92.8	92	66	98	45.5
TSF-M35	M35-1	12.47	-	966	7,643	3466	1448.5	-	926	7,327	3426	1388.6
TSF-M35	M35-2	12.47	207.0	290	740	2583	228.2	248.1	278	710	2530	169.1
TSF-M35	M35-3	12.47	304.2	331	2,410	2527	192.7	364.6	318	2,310	2453	111.8
TSF-M35	M35-4	12.47	1,146.6	835	1,446	2188	105.6	1,374.3	800	1,386	1926	-173.9
TSF-M35	M35-5	12.47	299.4	187	908	2387	-19.3	358.8	179	871	2320	-90.3
TSF-M36	M36-1	12.47	188.4	1,019	2,325	3331	1340.5	225.8	977	2,229	3251	1239.9
TSF-M36	M36-2	12.47	33.5	220	428	2687	296.7	40.1	211	410	2671	276.4
TSF-M36	M36-3	12.47	26.6	397	1,063	2870	568.6	31.9	380	1,019	2849	538.7
TSF-M37	M37-1	12.47	289.0	4,337	25,160	5548	4377.8	346.4	4,158	24,120	5312	3686.1
TSF-M37	M37-2	12.47	1,423.8	-	-	0	-	1,706.5	-	-	0	-
TSF-M37	M37-3	12.47	415.5	-	-	0	-	498.0	-	-	0	-
Hawaii Electric Light												
TSF-L1	L1-1	12.47	958.4	1,833	3,121	3371	1791.4	1,148.7	1,815	3,091	3162	1574.2
TSF-L1	L1-2	12.47	193.9	416	1,112	4907	429.4	232.4	411	1,101	4864	384.8
TSF-L2	L2-1	12.47	237.5	1,026	2,676	4212	1302.0	284.6	1,016	2,650	4155	1239.8
TSF-L2	L2-2	12.47	91.3	975	2,315	2938	1371.9	109.4	966	2,293	2911	1339.4
TSF-L3	L3-1	12.47	724.8	924	3,978	1489	661.2	868.7	915	3,939	1336	503.8
TSF-L3	L3-2	12.47	909.7	2,147	2,795	2259	2311.3	1,090.4	2,126	2,767	2058	2099.2
TSF-L4	L4-1	2.4	203.8	202	405	115	98.8	244.3	200	401	72	55.4
TSF-L5	L5-1	2.4	238.6	543	901	595	575.3	286.0	537	892	542	520.0
TSF-L6	L6-1	12.47	137.4	1,208	1,709	3119	1674.0	164.7	1,196	1,693	3080	1629.0
TSF-L7	L7-1	12.47	301.2	624	816	1573	635.3	361.0	618	808	1507	566.3
TSF-L8	L8-1	4.16	510.8	512	884	1086	257.2	612.2	507	876	979	148.3

SUBSTATION	CKT	Primary Voltage (kV)	2014										2016 Existing										2016 Short Term									
			Total DG kW on Primary -	Existing Primary Load (kVA)	Existing Primary Min Load (kVA)	Existing Primary Peak Load (kVA)	Existing Backbone Capacity (kVA)	Existing 50% Backbone Feeder Rating (kW)	Existing DG to 50% Backbone Feeder Rating (kW)	Existing Feeder Level Remaining DG kW to 100% Gross DML	Existing Feeder Level Remaining DG kW to 120% Gross DML	Existing Feeder Level Remaining DG kW to 150% Gross DML	Total DG kW on Primary - 2016 Short Term	2016 Primary Min Load (kVA)	2016 Primary Peak Load (kVA)	2016 Remaining Backbone Feeder Rating (kW)	2016 Remaining DG to 50% Backbone Feeder Rating (kW)	2016 Remaining DG to 150% Gross DML														
TSF-L8	L8-2	12.47	133.0	488.0	629.0	1855	2210	452.6	599.0	167.2	483	623	2172	557.9																		
TSF-L9	L9-1	12.47	248.1	865.5	1,690.0	5562	6179	790.5	1050.1	370.7	857	1,674	6048	915.3																		
TSF-L9	L9-2	12.47	283.8	519.4	1,550.0	5562	5797	339.4	495.2	356.8	514	1,535	5719	414.9																		
TSF-L10	L10-1	2.4	69.0	163.0	301.0	1070	1164	126.6	175.5	78.4	161	298	1153	163.8																		
TSF-L11	L11-1	12.47	712.0	880.3	2,620.0	5972	6140	168.3	344.3	1,388.2	872	2,595	5456	-80.3																		
TSF-L11	L11-2	12.47	33.5	459.4	590.0	5972	6398	425.9	517.8	90.0	455	584	6337	592.6																		
TSF-L12	L12-1	12.47	967.4	1,489.5	3,710.0	5562	6084	522.2	820.1	1,290.8	1,475	3,675	5746	922.4																		
TSF-L12	L12-2	12.47	545.5	892.3	1,880.0	5562	5908	346.8	525.2	718.7	884	1,862	5727	607.1																		
TSF-L13	L13-1	12.47	2,068.8	2,598.1	5,860.0	5562	6091	529.3	1048.9	2,583.3	2,574	5,805	5552	1277.0																		
TSF-L14	L14-1	12.47	998.9	942.5	2,500.0	5562	5905	56.4	132.1	1,242.1	934	2,476	5253	158.3																		
TSF-L14	L14-2	12.47	921.6	1,866.4	2,410.0	5972	944.8	1318.1	1878.0	1,047.8	1,849	2,387	6773	1725.3																		
TSF-L14	L14-3	12.47	77.6	236.7	940.0	5562	5721	159.1	206.4	105.6	234	931	5691	246.1																		
TSF-L14	L14-4	12.47	1,159.1	1,304.1	2,930.0	5972	6117	145.0	405.8	1,422.2	1,292	2,902	5842	515.5																		
TSF-L15	L15-1	12.47	691.5	3,136.8	3,700.0	5972	8417	2445.3	3072.7	1,269.4	3,107	3,665	7810	3391.4																		
TSF-L15	L15-2	12.47	229.8	490.3	4,888.0	5562	5822	260.5	358.5	261.2	486	4,842	5786	467.2																		
TSF-L15	L15-3	12.47	1,826.8	3,329.5	6,250.0	5972	7475	1502.7	2168.6	2,106.3	3,298	6,191	7164	2840.7																		
TSF-L16	L16-1	12.47	747.1	967.9	2,670.0	5562	5783	220.9	414.5	1,024.0	959	2,645	5496	414.2																		
TSF-L16	L16-2	12.47	148.2	71.0	210.0	5562	5485	-77.1	-62.9	170.3	70	208	5462	-64.8																		
TSF-L16	L16-3	12.47	665.8	566.5	1,400.0	5562	5462	-99.2	14.1	756.9	561	1,387	5366	84.8																		
TSF-L16	L16-4	12.47	67.2	72.9	180.0	5562	5567	5.7	20.3	76.4	72	178	5557	31.9																		
TSF-L17	L17-1	12.47	57.1	471.6	1,036.0	5562	5976	414.5	508.8	65.0	467	1,026	5964	635.7																		
TSF-L17	L17-2	12.47	490.9	826.4	1,408.0	5562	5897	335.5	500.8	696.2	819	1,395	5684	531.6																		
TSF-L18	L18-1	13.8	331.5	701.3	1,562.0	6155	6525	369.8	510.1	506.5	695	1,547	6343	535.5																		
TSF-L18	L18-2	13.8	210.7	1,359.3	2,959.0	6155	7303	1148.5	1420.4	573.6	1,346	2,931	6928	1446.0																		
TSF-L18	L18-3	13.8	311.8	618.2	1,240.0	6155	6461	306.4	430.1	367.1	612	1,228	6400	551.4																		
TSF-L18	L18-4	13.8	97.9	266.1	922.0	6155	6323	168.2	221.5	111.3	264	913	6307	284.1																		
TSF-L18	L18-5	13.8	503.6	678.4	1,435.0	6155	6330	174.9	310.6	572.5	672	1,421	6254	435.5																		
TSF-L19	L19-1	13.8	3.0	577.4	899.0	6155	6729	574.4	689.9	21.5	572	891	6705	836.4																		
TSF-L19	L19-2	13.8	417.5	1,254.2	2,704.8	6155	6992	836.7	1087.5	668.9	1,242	2,679	6728	1194.6																		
TSF-L20	L20-1	12.47	403.8	1,009.5	1,416.0	5562	6167	605.7	807.6	623.6	1,000	1,403	5938	876.3																		
TSF-L20	L20-2	12.47	674.2	1,632.2	3,268.0	5562	6520	958.1	1284.5	766.5	1,617	3,237	6412	1658.7																		
TSF-L20	L20-3	12.47	179.0	1,578.5	3,348.0	5562	6961	1399.5	1715.2	223.9	1,564	3,316	6901	2121.5																		
TSF-L21	L21-1	12.47	129.4	203.1	400.0	5562	5635	73.6	114.3	172.6	201	396	5590	129.1																		
TSF-L21	L21-2	12.47	75.3	212.0	1,160.0	5562	5698	136.7	179.1	91.4	210	1,149	5680	223.6																		
TSF-L21	L21-3	12.47	342.9	388.0	1,320.0	5562	5607	45.1	122.7	428.2	384	1,308	5518	148.2																		
TSF-L22	L22-1	12.47	1,057.3	42.5	120.0	5562	4547	-1014.8	-1006.3	1,202.1	42	119	4402	-1138.9																		
TSF-L22	L22-2	12.47	158.5	941.8	1,950.0	5562	6345	783.4	971.7	7,901.4	933	1,932	-1407	-6502.0																		
TSF-L23	L23-1	12.47	623.6	1,037.3	2,004.0	5562	5975	413.7	621.2	801.6	1,028	1,985	5788	739.7																		
TSF-L24	L24-1	12.47	929.3	1,191.9	3,130.0	5562	5824	262.7	501.1	1,115.5	1,181	3,100	5677	655.5																		
TSF-L24	L24-2	12.47	306.6	320.2	1,300.0	5562	5575	13.6	77.7	358.9	317	1,288	5520	116.9																		
TSF-L25	L25-1	12.47	49.9	66.7	220.0	5562	5578	16.8	30.1	69.2	66	218	5558	29.8																		

SUBSTATION	CKT	Primary Voltage (kV)	2020 Short Term				2020 Feeder Level				2030 Long Term				2030 Feeder Level Remaining DG kW to 150% Gross DML
			Total DG kW on Primary - 2020 Mid Term	2020 Primary Min Load (kVA)	2020 Primary Peak Load (kVA)	Remaining DG to 50% Backbone Feeder Rating (kW)	Total DG kW on Primary - 2020 Mid Term	2020 Primary Min Load (kVA)	2020 Primary Peak Load (kVA)	Remaining DG to 50% Backbone Feeder Rating (kW)	Total DG kW on Primary - 2030 Long Term	2030 Primary Min Load (kVA)	2030 Primary Peak Load (kVA)	Remaining DG to 50% Backbone Feeder Rating (kW)	
TSF-L8	L8-2	4.16	202.1	498	642	2151	544.5	242.2	493	635	2106	497.1	774.1		
TSF-L9	L9-1	12.47	448.1	883	1,724	5996	876.1	537.1	874	1,707	5899	269.9	774.1		
TSF-L9	L9-2	12.47	431.3	530	1,581	5660	363.3	516.9	525	1,565	5569	269.9	774.1		
TSF-L10	L10-1	2.4	94.8	166	307	1142	154.6	113.7	165	304	1121	133.3	133.3		
TSF-L11	L11-1	12.47	1,678.2	898	2,672	5192	-331.5	2,011.5	889	2,646	4850	-677.9	133.3		
TSF-L11	L11-2	12.47	1,088.8	469	602	6332	594.0	1,304.4	464	596	6306	565.5	133.3		
TSF-L12	L12-1	12.47	1,560.5	1,519	3,784	5520	718.4	1,870.3	1,504	3,747	5196	386.3	133.3		
TSF-L12	L12-2	12.47	868.8	910	1,918	5603	496.3	1,041.3	901	1,899	5422	310.5	133.3		
TSF-L13	L13-1	12.47	3,123.0	2,650	5,977	5089	851.9	3,743.1	2,624	5,918	4443	193.0	133.3		
TSF-L14	L14-1	12.47	1,501.6	961	2,550	5021	-59.7	1,799.8	952	2,525	4714	-371.9	133.3		
TSF-L14	L14-2	12.47	1,266.7	1,904	2,458	6609	1588.7	1,518.2	1,885	2,434	6339	1309.3	133.3		
TSF-L14	L14-3	12.47	127.6	241	959	5675	234.5	152.9	239	949	5648	205.6	133.3		
TSF-L14	L14-4	12.47	1,719.3	1,330	2,988	5583	275.9	2,060.7	1,317	2,959	5228	-85.0	133.3		
TSF-L15	L15-1	12.47	1,534.6	3,199	3,774	7637	3264.5	1,839.3	3,168	3,737	7301	2912.9	133.3		
TSF-L15	L15-2	12.47	315.8	500	4,986	5746	434.2	378.5	495	4,937	5678	364.2	133.3		
TSF-L15	L15-3	12.47	2,546.3	3,396	6,375	6822	2547.5	3,051.9	3,363	6,312	6283	1992.1	133.3		
TSF-L16	L16-1	12.47	1,237.9	987	2,723	5311	243.0	1,483.7	978	2,697	5056	-17.3	133.3		
TSF-L16	L16-2	12.47	205.9	72	214	5428	-97.2	246.8	72	212	5387	-139.2	133.3		
TSF-L16	L16-3	12.47	915.1	578	1,428	5224	-48.3	1,096.7	572	1,414	5037	-238.5	133.3		
TSF-L16	L16-4	12.47	92.3	74	184	5544	19.2	110.6	74	182	5525	-0.2	133.3		
TSF-L17	L17-1	12.47	78.5	481	1,057	5964	643.0	94.1	476	1,046	5944	620.3	133.3		
TSF-L17	L17-2	12.47	841.7	843	1,436	5563	422.6	1,008.8	835	1,422	5387	243.1	133.3		
TSF-L18	L18-1	13.8	612.3	715	1,593	6258	460.6	733.9	708	1,578	6129	328.5	133.3		
TSF-L18	L18-2	13.8	693.5	1,386	3,018	6848	1386.1	831.1	1,373	2,989	6697	1228.1	133.3		
TSF-L18	L18-3	13.8	443.8	631	1,265	6342	502.0	531.9	624	1,252	6247	404.6	133.3		
TSF-L18	L18-4	13.8	134.5	271	940	6292	272.6	161.2	269	931	6262	241.9	133.3		
TSF-L18	L18-5	13.8	692.1	692	1,464	6155	345.8	829.6	685	1,449	6010	198.2	133.3		
TSF-L19	L19-1	13.8	26.0	589	917	6718	857.4	31.1	583	908	6707	843.6	133.3		
TSF-L19	L19-2	13.8	808.7	1,279	2,759	6625	1110.2	969.3	1,267	2,732	6452	930.8	133.3		
TSF-L20	L20-1	12.47	753.9	1,030	1,444	5837	790.5	903.6	1,020	1,430	5678	625.7	133.3		
TSF-L20	L20-2	12.47	926.6	1,665	3,333	6300	1570.6	1,110.6	1,649	3,301	6100	1362.2	133.3		
TSF-L20	L20-3	12.47	270.6	1,610	3,415	6901	2144.3	324.4	1,594	3,381	6831	2066.9	133.3		
TSF-L21	L21-1	12.47	208.6	207	408	5560	102.0	250.1	205	404	5517	57.5	133.3		
TSF-L21	L21-2	12.47	110.5	216	1,183	5667	213.9	132.4	214	1,172	5643	188.8	133.3		
TSF-L21	L21-3	12.47	517.7	396	1,346	5440	75.9	620.5	392	1,333	5333	-32.7	133.3		
TSF-L22	L22-1	12.47	1,463.2	43	122	4152	-1388.2	1,741.7	43	121	3863	-1677.3	133.3		
TSF-L22	L22-2	12.47	9,552.0	961	1,989	-3030	-8111.1	11,448.7	951	1,969	-4936	-10021.8	133.3		
TSF-L23	L23-1	12.47	969.0	1,058	2,044	5651	618.0	1,161.4	1,048	2,024	5448	410.1	133.3		
TSF-L24	L24-1	12.47	1,348.5	1,216	3,192	5429	475.0	1,616.3	1,204	3,161	5149	189.4	133.3		
TSF-L24	L24-2	12.47	433.9	327	1,326	5454	56.0	520.1	323	1,313	5365	-34.9	133.3		
TSF-L25	L25-1	12.47	83.7	68	224	5546	18.3	100.3	67	222	5529	0.7	133.3		

SUBSTATION	CKT	Primary Voltage (kV)	Existing										2016 Short Term				2016 Feeder Level Remaining DG kW to 150% Gross DML
			Total DG (kW) on Primary - 2014	Existing Primary Load (kVA)	Existing Primary Peak Load (kVA)	Existing 50% Backbone Capacity (kVA)	Existing 50% Backbone Feeder Rating (kW)	Existing DG to 100% Gross DML	Existing DG to 120% Gross DML	Existing Feeder Level Remaining DG kW to 150% Gross DML	2016 Primary Min Load (kVA)	2016 Primary Peak Load (kVA)	2016 Remaining to 50% Backbone Feeder Rating (kW)	2016 Short Term Remaining DG to 150% Gross DML			
TSF-L25	L25-2	12.47	345.6	273.6	800.0	5562	5490	-72.0	-17.3	64.8	393.0	271	792	5440	13.6		
TSF-L26	L26-1	12.47	999.3	891.1	3,070.0	5562	5453	-108.2	70.0	337.4	1,174.1	883	3,041	5270	150.0		
TSF-L26	L26-2	12.47	915.0	702.0	2,450.0	5562	5349	-213.1	-72.7	137.9	1,142.3	695	2,427	5115	-99.3		
TSF-L27	L27-1	12.47	57.7	577.0	713.5	5972	6491	519.3	634.7	807.8	859.1	572	707	5685	-1.8		
TSF-L27	L27-2	12.47	97.9	171.5	278.0	5972	6046	73.6	107.9	159.4	111.3	170	275	6031	143.5		
TSF-L27	L27-3	12.47	436.2	361.6	1,014.0	5972	5897	-74.7	-2.4	106.1	496.0	358	1,004	5834	41.2		
TSF-L28	L28-1	12.47	88.7	128.4	983.0	5562	5601	39.7	65.4	103.9	108.6	127	974	5580	82.1		
TSF-L28	L28-2	12.47	265.3	589.6	1,648.0	5562	5886	324.3	442.2	619.1	373.7	584	1,632	5772	502.4		
TSF-L29	L29-1	12.47	504.8	494.5	940.0	5972	5962	-10.3	88.6	237.0	701.7	490	931	5760	33.1		
TSF-L30	L30-1	12.47	179.6	365.8	840.0	5562	5748	186.3	259.4	369.2	1,644.4	362	832	4280	-1100.9		
TSF-L30	L30-2	12.47	179.2	513.7	1,410.0	5562	5896	334.6	437.3	591.4	243.3	509	1,397	5827	520.0		
TSF-L31	L31-1	12.47	443.9	612.8	1,270.0	5562	5731	168.9	291.4	475.2	555.9	607	1,258	5613	354.6		
TSF-L31	L31-2	12.47	186.0	896.1	1,650.0	5562	6272	710.1	889.3	1158.1	227.8	888	1,634	6222	1103.7		
TSF-L32	L32-1	12.47	1,708.6	1,921.3	5,090.0	5562	5774	212.7	596.9	1173.3	2,046.3	1,903	5,042	5418	808.4		
TSF-L32	L32-2	12.47	2,026.3	2,665.8	3,670.0	5562	6201	639.5	1172.7	1972.4	2,758.2	2,641	3,635	5444	1202.7		
TSF-L32	L32-3	12.47	90.9	139.4	250.0	5562	5610	48.5	76.4	118.2	124.3	138	248	5575	82.8		
TSF-L33	L33-1	12.47	1,007.1	2,853.4	5,860.0	5562	7408	1846.2	2416.9	3272.9	1,662.6	2,826	5,805	6726	2577.1		
TSF-L33	L33-2	12.47	278.2	212.6	540.0	5562	5496	-65.6	-23.1	40.7	318.0	211	535	5454	-2.1		
TSF-L33	L33-3	12.47	1,425.5	1,525.2	2,700.0	5562	5661	99.7	404.7	862.2	1,805.7	1,511	2,674	5267	460.4		
TSF-L34	L34-1	12.47	397.2	579.7	950.0	5562	5744	182.5	298.5	472.4	489.3	574	941	5647	372.0		
TSF-L35	L35-1	12.47	1,590.1	2,647.0	4,520.0	5562	6619	1056.9	1586.3	2380.4	2,102.4	2,622	4,477	6081	1830.7		
TSF-L35	L35-2	12.47	119.8	87.2	200.0	5562	5529	-32.6	-15.4	10.9	143.0	86	198	5505	-13.4		
TSF-L36	L36-1	2.4	46.3	37.1	94.5	1070	1061	-9.2	-1.8	9.4	52.6	37	94	1055	2.5		
TSF-L36	L36-2	2.4	26.8	190.5	324.2	1070	1234	163.7	201.8	259.0	143.2	189	321	1116	139.9		
TSF-L37	L37-1	12.47	163.9	130.6	269.0	5562	5562	33.2	-7.1	32.1	186.3	129	266	5505	7.8		
TSF-L37	L37-2	12.47	83.0	105.0	478.0	5562	5584	22.0	43.0	74.5	98.4	104	473	5567	57.6		
TSF-L38	L38-1	12.47	749.5	1,653.1	2,800.0	5972	6876	903.6	1234.3	1730.2	1,128.7	1,638	2,774	6481	1327.5		
TSF-L38	L38-2	12.47	441.1	2,180.6	3,680.0	5972	7712	1739.5	2175.6	2829.8	566.7	2,160	3,645	7565	2673.2		
TSF-L39	L39-1	12.47	299.8	1,078.6	2,027.5	5562	6340	778.7	994.4	1318.0	383.8	1,068	2,008	6246	1218.8		
TSF-L39	L39-2	12.47	88.6	64.3	308.2	5562	5537	-24.3	-11.4	7.9	191.0	64	305	5434	-95.4		
TSF-L40	L40-1	12.47	80.6	181.4	266.0	5562	5663	100.9	137.1	191.6	116.5	180	263	5625	153.1		
TSF-L41	L41-1	12.47	111.3	80.7	270.0	5562	5531	-30.6	-14.4	9.8	126.5	80	267	5515	-6.6		
TSF-L42	L42-1	12.47	36.9	168.0	450.0	5562	5693	131.1	164.7	215.1	41.9	166	446	5686	207.7		
TSF-L42	L42-2	12.47	84.2	315.8	974.8	5562	5793	231.6	294.8	389.5	113.3	313	966	5761	356.0		
TSF-L43	L43-1	12.47	1,278.5	1,505.0	2,200.0	5972	6198	226.4	527.4	978.9	1,483.0	1,491	2,179	5980	753.1		
TSF-L43	L43-2	12.47	85.4	1,209.2	1,920.0	5972	7096	1123.8	1365.6	1728.4	123.3	1,198	1,902	7046	1673.3		
TSF-L44	L44-1	4.16	84.9	393.9	820.4	1855	2164	309.0	387.8	506.0	111.2	390	813	2134	474.1		
TSF-L45	L45-1	12.47	72.5	318.6	630.9	5562	5808	246.0	309.7	405.3	135.0	316	625	5742	338.3		
TSF-L45	L45-2	12.47	24.7	38.0	339.4	5562	5575	13.3	20.9	32.3	28.0	38	336	5571	28.4		
TSF-L46	L46-1	12.47	489.5	499.6	680.0	5972	5982	10.0	109.9	259.8	566.6	495	674	5910	185.7		
TSF-L46	L46-2	12.47	747.2	967.8	2,970.0	5972	6193	220.6	414.2	704.5	936.4	959	2,942	5994	501.6		

SUBSTATION	CKT	Primary Voltage (kV)	2020 Short Term				2020 Feeder Level				2030 Long Term				2030 Feeder Level Remaining DG kW to 150% Gross DML
			Total DG kW on Primary - 2020 Mid Term	2020 Primary Min Load (kVA)	2020 Primary Peak Load (kVA)	Remaining DG to 50% Backbone Feeder Rating (kW)	Total DG kW on Primary - 2020 Mid Term	2020 Primary Min Load (kVA)	2020 Primary Peak Load (kVA)	Remaining DG to 50% Backbone Feeder Rating (kW)	Total DG kW on Primary - 2030 Long Term	2030 Primary Min Load (kVA)	2030 Primary Peak Load (kVA)	Remaining DG to 50% Backbone Feeder Rating (kW)	
TSF-L25	L25-2	12.47	475.0	279	816	5366	-56.5	569.4	276	808	5269	-154.9			
TSF-L26	L26-1	12.47	1,419.3	909	3,131	5051	-56.0	1,701.2	900	3,101	4760	-351.2			
TSF-L26	L26-2	12.47	1,381.0	716	2,499	4897	-307.0	1,655.2	709	2,474	4615	-591.7			
TSF-L27	L27-1	12.47	1,038.5	589	728	5522	-155.8	1,244.8	583	721	5310	-370.6			
TSF-L27	L27-2	12.47	134.5	175	284	6012	127.8	161.2	173	281	5984	98.6			
TSF-L27	L27-3	12.47	599.6	369	1,034	5741	-46.5	718.7	365	1,024	5619	-170.9			
TSF-L28	L28-1	12.47	131.3	131	1,003	5561	65.1	157.4	130	993	5534	37.1			
TSF-L28	L28-2	12.47	451.8	601	1,681	5711	450.3	541.5	595	1,664	5616	351.8			
TSF-L29	L29-1	12.47	848.3	504	959	5628	-91.7	1,016.8	499	949	5455	-267.6			
TSF-L30	L30-1	12.47	1,988.0	373	857	3947	-1428.3	2,382.7	369	848	3548	-1828.5			
TSF-L30	L30-2	12.47	294.1	524	1,438	5792	491.8	352.5	519	1,424	5728	425.7			
TSF-L31	L31-1	12.47	672.0	625	1,295	5515	265.5	805.5	619	1,283	5375	122.8			
TSF-L31	L31-2	12.47	275.3	914	1,683	6200	1095.6	330.0	905	1,666	6137	1027.5			
TSF-L32	L32-1	12.47	2,473.8	1,860	5,192	5047	465.6	2,965.1	1,940	5,141	4537	-54.3			
TSF-L32	L32-2	12.47	3,334.4	2,719	3,743	4946	744.0	3,996.5	2,692	3,707	4258	42.1			
TSF-L32	L32-3	12.47	150.3	142	255	5554	63.0	180.2	141	252	5522	31.0			
TSF-L33	L33-1	12.47	2,009.9	2,910	5,977	6462	2355.6	2,409.0	2,882	5,918	6035	1913.8			
TSF-L33	L33-2	12.47	384.4	217	551	5394	-59.1	460.7	215	545	5316	-138.6			
TSF-L33	L33-3	12.47	2,183.0	1,556	2,754	4934	150.4	2,616.4	1,540	2,727	4486	-305.8			
TSF-L34	L34-1	12.47	591.6	591	969	5561	295.4	709.0	586	959	5438	169.2			
TSF-L35	L35-1	12.47	2,541.6	2,700	4,610	5720	1508.2	3,046.2	2,673	4,565	5189	963.9			
TSF-L35	L35-2	12.47	172.9	89	204	5478	-39.5	207.2	88	202	5443	-75.1			
TSF-L36	L36-1	2.4	63.6	38	96	1045	-6.9	76.3	37	95	1032	-20.1			
TSF-L36	L36-2	2.4	173.1	194	331	1092	118.3	207.5	192	327	1055	81.1			
TSF-L37	L37-1	12.47	225.2	133	274	5470	-25.4	270.0	132	272	5424	-72.0			
TSF-L37	L37-2	12.47	119.0	107	488	5550	41.7	142.6	106	483	5525	16.5			
TSF-L38	L38-1	12.47	1,364.5	1,686	2,856	6294	1164.6	1,635.5	1,670	2,828	6006	868.9			
TSF-L38	L38-2	12.47	685.1	2,224	3,753	7511	2651.0	821.2	2,202	3,717	7353	2482.3			
TSF-L39	L39-1	12.47	463.9	1,100	2,068	6198	1186.2	556.0	1,089	2,048	6095	1077.9			
TSF-L39	L39-2	12.47	230.8	66	314	5396	-132.5	276.7	65	311	5350	-179.3			
TSF-L40	L40-1	12.47	140.8	185	271	5606	136.8	168.8	183	269	5576	106.1			
TSF-L41	L41-1	12.47	152.9	82	275	5491	-29.5	183.3	82	273	5460	-61.0			
TSF-L42	L42-1	12.47	50.7	171	459	5682	206.3	60.7	170	454	5671	193.8			
TSF-L42	L42-2	12.47	136.9	322	994	5747	346.2	164.1	319	985	5716	314.3			
TSF-L43	L43-1	12.47	1,792.8	1,535	2,244	5714	509.6	2,148.8	1,520	2,222	5343	131.1			
TSF-L43	L43-2	12.47	149.1	1,233	1,958	7056	1700.9	178.7	1,221	1,939	7015	1653.2			
TSF-L44	L44-1	4.16	134.4	402	837	2123	468.2	161.1	398	829	2092	435.6			
TSF-L45	L45-1	12.47	163.2	325	643	5723	324.2	195.6	322	637	5688	287.0			
TSF-L45	L45-2	12.47	33.9	39	346	5567	24.2	40.6	38	343	5559	16.9			
TSF-L46	L46-1	12.47	672.9	510	694	5809	91.4	806.5	505	687	5670	-49.7			
TSF-L46	L46-2	12.47	1,132.1	987	3,029	5827	348.6	1,356.8	977	3,000	5593	109.3			

SUBSTATION	CKT	Primary Voltage (kV)	2014										2016									
			Total DG (kW) on Primary -	Existing Primary Min Load (kW)	Existing Primary Peak Load (kW)	Existing Capacity (kVA)	Existing 50% Backbone Feeder Capacity (kVA)	Existing Remaining DG to 50% Backbone Feeder Rating (kW)	Existing Feeder Level Remaining DG kW to 100% Gross DML	Existing Feeder Level Remaining DG kW to 120% Gross DML	Existing Feeder Level Remaining DG kW to 150% Gross DML	Total DG kW on Primary - 2016 Short Term	2016 Primary Min Load (kVA)	2016 Primary Peak Load (kVA)	Remaining DG to 50% Backbone Feeder Rating (kW)	2016 Short Term Remaining DG to 50% Backbone Feeder Rating (kW)	2016 Feeder Level Remaining DG kW to 150% Gross DML					
TSF-L47	L47-1	12.47	3,065.2	696.2	1,690.0	5562	3193	-2369.0	-2229.8	-2020.9	3,485.0	690	1,674	2766	-2450.5							
TSF-L47	L47-2	12.47	559.4	1,530.0	3,740.0	5562	6532	970.7	1276.7	1735.7	1,149.2	1,516	3,705	5928	1124.2							
TSF-L48	L48-1	2.4	91.5	1,609.9	315.5	1070	1140	69.4	101.5	149.8	104.1	159	313	1126	135.0							
TSF-L49	L49-1	12.47	174.3	580.2	790.0	5972	6378	405.9	521.9	696.0	440.9	575	783	6106	421.2							
TSF-L49	L49-2	12.47	120.4	1,620.4	2,600.0	5972	7472	1500.1	1824.2	2310.3	154.0	1,605	2,575	7423	2253.6							
TSF-L49	L49-3	12.47	53.9	501.3	710.0	5972	6419	447.3	547.6	698.0	118.6	497	703	6350	626.1							
TSF-L49	L49-4	12.47	256.3	1,063.0	2,750.0	5972	6779	806.7	1019.3	1338.2	721.2	1,053	2,724	6304	858.3							
TSF-L50	L50-1	12.47	1,030.3	374.3	950.0	5562	4906	656.1	581.2	468.9	1,171.4	371	941	4761	615.4							
TSF-L50	L50-2	12.47	54.3	240.3	540.0	5562	5748	186.1	234.1	306.2	92.0	238	535	5708	265.1							
TSF-L51	L51-1	12.47	445.2	803.7	1,950.0	5562	5920	358.6	519.3	760.4	615.6	796	1,932	5742	578.6							
TSF-L51	L51-2	12.47	295.5	1,979.9	3,860.0	5562	7246	1684.4	2080.4	2674.4	440.0	1,961	3,824	7083	2501.8							
TSF-L51	L51-3	13.8	337.8	1,072.6	4,129.0	6155	6890	734.8	949.4	1271.2	473.4	1,062	4,090	6744	1120.3							
TSF-L52	L52-1	12.47	331.1	707.0	1,715.6	5562	5938	375.9	517.3	729.4	445.5	700	1,699	5817	605.0							
TSF-L53	L53-1	12.47	-	38.0	356.0	5972	6010	38.0	45.6	57.0	-	38	353	6010	56.5							
TSF-L53	L53-2	12.47	95.6	98.0	250.0	5562	5564	2.4	22.0	51.4	130.8	97	248	5528	14.8							
TSF-L54	L54-1	12.47	66.0	321.0	600.0	5562	5817	255.0	319.2	415.5	85.8	318	594	5794	391.2							
TSF-L55	L55-1	12.47	259.0	301.4	410.0	5562	5604	42.4	102.7	193.1	308.8	299	406	5551	139.1							
TSF-L55	L55-2	12.47	30.0	62.7	240.0	5562	5594	32.7	45.3	64.1	38.0	62	238	5586	55.2							
TSF-L56	L56-1	2.4	49.9	439.0	635.0	1070	1459	389.1	476.9	608.6	81.5	435	629	1424	570.8							
TSF-L57	L57-1	12.47	27.3	20.0	60.0	5562	5554	-7.3	-3.3	2.7	31.0	20	59	5550	-1.3							
TSF-L57	L57-2	12.47	559.3	675.5	1,180.0	5972	6088	116.2	251.3	454.0	785.4	669	1,169	5856	218.3							
TSF-L58	L58-1	12.47	265.2	387.7	412.0	5972	6095	122.5	200.0	316.3	425.2	384	408	5931	150.8							
TSF-L59	L59-1	12.47	725.3	1,037.0	2,380.0	5972	6284	311.6	519.0	830.1	883.7	1,027	2,358	6116	657.1							
TSF-L59	L59-2	12.47	1,044.8	1,133.3	2,620.0	5972	6061	88.5	315.1	655.1	1,441.6	1,123	2,595	5653	242.3							
TSF-L60	L60-1	12.47	144.8	230.4	484.5	5562	5647	85.6	131.7	200.8	191.6	228	480	5598	150.7							
TSF-L61	L61-1	12.47	327.8	732.0	1,075.0	5562	5966	404.2	550.6	770.2	403.5	725	1,065	5883	684.1							

SUBSTATION	CKT	Primary Voltage (kV)	2020 Short Term				2020 Feeder Level				2030 Long Term				2030 Feeder Level Remaining DG kW to 150% Gross DML
			Total DG kW on Primary - 2020 Mid Term	2020 Primary Min Load (kVA)	2020 Primary Peak Load (kVA)	Remaining DG to 50% Backbone Feeder Rating (kW)	Total DG kW on Primary - 2020 Long Term	2020 Primary Min Load (kVA)	2020 Primary Peak Load (kVA)	Remaining DG to 50% Backbone Feeder Rating (kW)	Total DG kW on Primary - 2030 Long Term	2030 Primary Min Load (kVA)	2030 Primary Peak Load (kVA)	Remaining DG to 50% Backbone Feeder Rating (kW)	
TSF-L47	L47-1	12.47	4,213.1	710	1,724	2059	-3147.9	5,049.6	703	1,707	1,215	-3894.8			
TSF-L47	L47-2	12.47	1,389.2	1,561	3,815	5733	951.6	1,665.1	1,545	3,777	5442	652.9			
TSF-L48	L48-1	2.4	125.8	164	322	1109	120.4	150.8	163	319	1082	93.0			
TSF-L49	L49-1	12.47	533.0	592	806	6031	354.7	638.9	586	798	5919	240.1			
TSF-L49	L49-2	12.47	186.2	1,653	2,652	7439	2292.9	223.2	1,637	2,626	7385	2231.7			
TSF-L49	L49-3	12.47	143.4	511	724	6340	623.5	171.9	506	717	6306	587.5			
TSF-L49	L49-4	12.47	871.8	1,084	2,805	6184	754.5	1,044.9	1,074	2,777	6001	565.5			
TSF-L50	L50-1	12.47	1,416.1	382	969	4527	-843.6	1,697.3	378	959	4242	-1130.4			
TSF-L50	L50-2	12.47	111.2	245	551	5696	256.5	133.3	243	545	5671	230.8			
TSF-L51	L51-1	12.47	744.2	820	1,989	5637	485.5	891.9	812	1,969	5481	325.7			
TSF-L51	L51-2	12.47	531.9	2,019	3,937	7049	2497.2	637.6	2,000	3,898	6924	2361.9			
TSF-L51	L51-3	13.8	572.3	1,094	4,211	6677	1068.7	685.9	1,083	4,170	6552	939.1			
TSF-L52	L52-1	12.47	538.5	721	1,750	5744	543.1	645.4	714	1,733	5630	425.6			
TSF-L53	L53-1	12.47	-	39	363	6011	58.1	-	38	360	6010	57.6			
TSF-L53	L53-2	12.47	158.1	100	255	5503	-8.2	189.5	99	252	5471	-41.1			
TSF-L54	L54-1	12.47	103.7	327	612	5785	387.4	124.3	324	606	5762	362.0			
TSF-L55	L55-1	12.47	373.3	307	418	5496	87.9	447.4	304	414	5419	9.2			
TSF-L55	L55-2	12.47	45.9	64	245	5580	50.0	55.0	63	242	5570	40.0			
TSF-L56	L56-1	2.4	98.5	448	648	1420	573.1	118.1	443	641	1396	547.0			
TSF-L57	L57-1	12.47	37.5	20	61	5545	-6.9	44.9	20	61	5537	-14.6			
TSF-L57	L57-2	12.47	949.5	689	1,204	5712	84.0	1,138.0	682	1,192	5516	-114.6			
TSF-L58	L58-1	12.47	514.0	395	420	5853	79.1	616.1	392	416	5747	-28.8			
TSF-L59	L59-1	12.47	1,068.3	1,058	2,427	5961	518.2	1,280.4	1,047	2,404	5739	290.6			
TSF-L59	L59-2	12.47	1,742.7	1,156	2,672	5385	-8.9	2,088.8	1,145	2,646	5028	-371.9			
TSF-L60	L60-1	12.47	231.6	235	494	5565	120.9	277.6	233	489	5517	71.4			
TSF-L61	L61-1	12.47	487.8	747	1,096	5820	632.1	584.7	739	1,086	5716	524.3			

SUBSTATION	CKT	Grounding Transformer Cost (\$)		Distribution Transformer Cost (\$)		Pole and Secondary Cost (\$)			
		2016 Grounding Xfmr Addition (\$)	2030 Grounding Xfmr Addition (\$)	2016 Distribution Xfmr Upgrade (\$)	2030 Distribution Xfmr Upgrade (\$)	2016 Distribution Xfmr Upgrade (\$)	2030 Distribution Xfmr Upgrade (\$)		
Hawaiian Electric									
TSF-H1	H1-1			\$ 31,559.65	\$ 28,749.89	\$ 40,936.05	\$ 7,100.92	\$ 6,468.73	\$ 9,210.61
TSF-H1	H1-2			\$ 23,285.77	\$ 32,220	\$ 45,876	\$ 5,239.30	\$ 7,249	\$ 10,322
TSF-H2	H2-1			\$ 35,483.41	\$ 43,882	\$ 62,482	\$ 7,983.77	\$ 9,873	\$ 14,059
TSF-H2	H2-2			\$ -	\$ -	\$ -	\$ -	\$ -	\$ -
TSF-H3	H3-1			\$ -	\$ -	\$ -	\$ -	\$ -	\$ -
TSF-H3	H3-2			\$ 32,017.34	\$ 28,409	\$ 40,450	\$ 7,203.90	\$ 6,392	\$ 9,101
TSF-H4	H4-1			\$ 42,928.67	\$ 37,575	\$ 53,502	\$ 9,658.95	\$ 8,454	\$ 12,038
TSF-H4	H4-2			\$ -	\$ -	\$ -	\$ -	\$ -	\$ -
TSF-H5	H5-1			\$ -	\$ -	\$ -	\$ -	\$ -	\$ -
TSF-H5	H5-2			\$ -	\$ -	\$ -	\$ -	\$ -	\$ -
TSF-H6	H6-1			\$ -	\$ 9,532	\$ 18,084	\$ -	\$ 2,145	\$ 4,069
TSF-H7	H7-1			\$ 10,308.25	\$ 11,416	\$ 16,255	\$ 2,319.36	\$ 2,569	\$ 3,657
TSF-H8	H8-1			\$ 42,346.55	\$ 24,327	\$ 34,638	\$ 9,527.97	\$ 5,473	\$ 7,794
TSF-H8	H8-1			\$ -	\$ -	\$ 38,809	\$ -	\$ -	\$ 8,732
TSF-H9	H9-2			\$ -	\$ -	\$ -	\$ -	\$ -	\$ -
TSF-H10	H10-1			\$ 2,573.52	\$ 5,606	\$ 7,982	\$ 579.04	\$ 1,261	\$ 1,796
TSF-H11	H11-1			\$ -	\$ -	\$ -	\$ -	\$ -	\$ -
TSF-H12	H12-1			\$ -	\$ -	\$ -	\$ -	\$ -	\$ -
TSF-H13	H13-1			\$ -	\$ -	\$ -	\$ -	\$ -	\$ -
TSF-H13	H13-2			\$ -	\$ -	\$ -	\$ -	\$ -	\$ -
TSF-H14	H14-1			\$ 47,293.65	\$ 51,899	\$ 73,898	\$ 10,641.07	\$ 11,677	\$ 16,627
TSF-H15	H15-1			\$ -	\$ -	\$ 37,611	\$ -	\$ -	\$ 8,463
TSF-H15	H15-2			\$ -	\$ -	\$ -	\$ -	\$ -	\$ -
TSF-H16	H16-1			\$ -	\$ -	\$ -	\$ -	\$ -	\$ -
TSF-H17	H17-1			\$ -	\$ -	\$ -	\$ -	\$ -	\$ -
TSF-H18	H18-1			\$ -	\$ 10,786	\$ 40,616	\$ -	\$ 2,427	\$ 9,139
TSF-H18	H18-2			\$ 13,638.54	\$ 25,447	\$ 36,233	\$ 3,068.67	\$ 5,726	\$ 8,152
TSF-H19	H19-1			\$ 15,249.50	\$ 26,032	\$ 37,066	\$ 3,431.14	\$ 5,857	\$ 8,340
TSF-H19	H19-2			\$ 24,617.57	\$ 42,657	\$ 60,738	\$ 5,538.95	\$ 9,598	\$ 13,666
TSF-H20	H20-1			\$ -	\$ 15,473	\$ 36,424	\$ -	\$ 3,481	\$ 8,195
TSF-H21	H21-1			\$ 28,995.51	\$ 45,241	\$ 64,417	\$ 6,523.99	\$ 10,179	\$ 14,494
TSF-H22	H22-1			\$ -	\$ -	\$ -	\$ -	\$ -	\$ -
TSF-H22	H22-2			\$ -	\$ -	\$ -	\$ -	\$ -	\$ -
TSF-H23	H23-1			\$ -	\$ -	\$ -	\$ -	\$ -	\$ -
TSF-H23	H23-2			\$ -	\$ -	\$ -	\$ -	\$ -	\$ -
TSF-H24	H24-1			\$ -	\$ 4,247	\$ 14,212	\$ -	\$ 956	\$ 3,198
TSF-H24	H24-2			\$ 2,139.63	\$ 7,133	\$ 10,157	\$ 481.42	\$ 1,605	\$ 2,285
TSF-H25	H25-1			\$ 14,652.75	\$ 29,574	\$ 42,110	\$ 3,296.87	\$ 6,654	\$ 9,475
TSF-H25	H25-2			\$ 34,361.73	\$ 37,914	\$ 53,984	\$ 7,731.39	\$ 8,531	\$ 12,146
TSF-H26	H26-1			\$ 55,022.23	\$ 36,267	\$ 54,488	\$ 12,380.00	\$ 8,610	\$ 12,260
TSF-H26	H26-2			\$ -	\$ 22,878	\$ 30,746	\$ -	\$ 5,148	\$ 6,918

SUBSTATION	CKT	Regulator Cost (\$)		Upgrade Costs By Year (\$)				Total Cost of Upgrades (\$)
		2016 Regulator Upgrade (\$)	2030 Regulator Upgrade (\$)	2016 Total Cost of Upgrades (\$)	2020 Total Cost of Upgrades (\$)	2030 Total Cost of Upgrades (\$)	2030 Total Cost of Upgrades (\$)	
Hawaiian Electric								
TSF-H1	H1-1	\$ -	\$ -	\$ 31,289,661	\$ 3,160,319	\$ -	\$ 3,175,247	\$ 37,625,226
TSF-H1	H1-2	\$ -	\$ -	\$ 28,525	\$ 39,469	\$ -	\$ 56,199	\$ 124,193
TSF-H2	H2-1	\$ -	\$ -	\$ 43,467	\$ 53,756	\$ -	\$ 76,541	\$ 173,764
TSF-H2	H2-2	\$ -	\$ -	\$ -	\$ -	\$ -	\$ -	\$ -
TSF-H3	H3-1	\$ -	\$ -	\$ 11,000	\$ -	\$ -	\$ -	\$ 11,000
TSF-H3	H3-2	\$ -	\$ -	\$ 39,221	\$ 34,801	\$ -	\$ 49,552	\$ 123,573
TSF-H4	H4-1	\$ 11,000	\$ -	\$ 63,588	\$ 57,030	\$ -	\$ 65,540	\$ 186,157
TSF-H4	H4-2	\$ -	\$ -	\$ -	\$ -	\$ -	\$ -	\$ -
TSF-H5	H5-1	\$ -	\$ -	\$ -	\$ -	\$ -	\$ -	\$ -
TSF-H5	H5-2	\$ -	\$ -	\$ -	\$ -	\$ -	\$ -	\$ -
TSF-H6	H6-1	\$ -	\$ -	\$ -	\$ 11,677	\$ -	\$ 22,153	\$ 33,830
TSF-H7	H7-1	\$ -	\$ -	\$ 23,628	\$ 13,985	\$ -	\$ 19,913	\$ 57,525
TSF-H8	H8-1	\$ -	\$ -	\$ 62,875	\$ 2,504,800	\$ -	\$ 42,431	\$ 2,610,106
TSF-H9	H9-1	\$ -	\$ -	\$ -	\$ -	\$ -	\$ 58,541	\$ 58,541
TSF-H9	H9-2	\$ -	\$ -	\$ -	\$ -	\$ -	\$ -	\$ -
TSF-H10	H10-1	\$ -	\$ -	\$ 14,153	\$ 6,867	\$ -	\$ 9,778	\$ 30,797
TSF-H11	H11-1	\$ -	\$ -	\$ -	\$ -	\$ -	\$ -	\$ -
TSF-H12	H12-1	\$ -	\$ -	\$ -	\$ -	\$ -	\$ -	\$ -
TSF-H13	H13-1	\$ -	\$ -	\$ -	\$ -	\$ -	\$ -	\$ -
TSF-H13	H13-2	\$ -	\$ -	\$ -	\$ -	\$ -	\$ -	\$ -
TSF-H14	H14-1	\$ -	\$ -	\$ 57,935	\$ 63,577	\$ -	\$ 90,525	\$ 212,036
TSF-H15	H15-1	\$ -	\$ -	\$ -	\$ -	\$ -	\$ 46,074	\$ 46,074
TSF-H15	H15-2	\$ -	\$ -	\$ -	\$ -	\$ -	\$ -	\$ -
TSF-H16	H16-1	\$ -	\$ -	\$ -	\$ -	\$ -	\$ -	\$ -
TSF-H17	H17-1	\$ -	\$ -	\$ -	\$ -	\$ -	\$ -	\$ -
TSF-H18	H18-1	\$ -	\$ -	\$ 11,000	\$ 13,213	\$ -	\$ 49,755	\$ 73,968
TSF-H18	H18-2	\$ 11,000	\$ -	\$ 27,707	\$ 31,172	\$ -	\$ 44,385	\$ 103,265
TSF-H19	H19-1	\$ -	\$ -	\$ 29,681	\$ 31,889	\$ -	\$ 2,520,406	\$ 2,581,976
TSF-H19	H19-2	\$ -	\$ -	\$ 30,157	\$ 52,254	\$ -	\$ 74,403	\$ 156,814
TSF-H20	H20-1	\$ -	\$ -	\$ -	\$ 18,955	\$ -	\$ 44,619	\$ 63,574
TSF-H21	H21-1	\$ -	\$ -	\$ 35,520	\$ 55,420	\$ -	\$ 78,910	\$ 169,850
TSF-H22	H22-1	\$ -	\$ -	\$ -	\$ -	\$ -	\$ -	\$ -
TSF-H22	H22-2	\$ -	\$ -	\$ -	\$ -	\$ -	\$ -	\$ -
TSF-H23	H23-1	\$ -	\$ -	\$ -	\$ -	\$ -	\$ -	\$ -
TSF-H23	H23-2	\$ -	\$ -	\$ -	\$ -	\$ -	\$ -	\$ -
TSF-H24	H24-1	\$ -	\$ 11,000	\$ -	\$ -	\$ -	\$ -	\$ -
TSF-H24	H24-2	\$ -	\$ -	\$ 2,621	\$ 8,738	\$ -	\$ 12,442	\$ 23,801
TSF-H25	H25-1	\$ 11,000	\$ -	\$ 28,950	\$ 36,229	\$ -	\$ 2,526,585	\$ 2,591,763
TSF-H25	H25-2	\$ -	\$ -	\$ 42,093	\$ 46,444	\$ -	\$ 66,131	\$ 154,668
TSF-H26	H26-1	\$ -	\$ -	\$ 78,402	\$ 46,878	\$ -	\$ 66,747	\$ 192,027
TSF-H26	H26-2	\$ -	\$ -	\$ -	\$ 28,025	\$ -	\$ 37,664	\$ 65,689

SUBSTATION	CKT	Grounding Transformer Cost (\$)		Distribution Transformer Cost (\$)		Pole and Secondary Cost (\$)				
		2016 Grounding Xfmr Addition (\$)	2030 Grounding Xfmr Addition (\$)	2016 Distribution Xfmr Upgrade (\$)	2030 Distribution Xfmr Upgrade (\$)	2016 Distribution Xfmr Upgrade (\$)	2020 Distribution Xfmr Upgrade (\$)	2030 Distribution Xfmr Upgrade (\$)		
Hawaiian Electric										
TSF-H27	H27-1			\$ -	\$ 24,805	\$ 31,954	\$ -	\$ -	\$ 5,581	\$ 7,190
TSF-H27	H27-2			\$ -	\$ 10,279	\$ 36,616	\$ -	\$ -	\$ 2,313	\$ 8,239
TSF-H28	H28-1			\$ -	\$ -	\$ 25,278	\$ -	\$ -	\$ -	\$ 5,688
TSF-H28	H28-2			\$ -	\$ -	\$ 17,546	\$ -	\$ -	\$ -	\$ 3,948
TSF-H29	H29-1			\$ -	\$ -	\$ -	\$ -	\$ -	\$ -	\$ -
TSF-H30	H30-1			\$ -	\$ -	\$ -	\$ -	\$ -	\$ -	\$ -
TSF-H30	H30-2			\$ -	\$ -	\$ -	\$ -	\$ -	\$ -	\$ -
TSF-H31	H31-1			\$ -	\$ -	\$ -	\$ -	\$ -	\$ -	\$ -
TSF-H32	H32-1			\$ -	\$ -	\$ -	\$ -	\$ -	\$ -	\$ -
TSF-H33	H33-1			\$ -	\$ -	\$ -	\$ -	\$ -	\$ -	\$ -
TSF-H33	H33-2			\$ 30,218.87	\$ 37,448	\$ 53,321	\$ 6,799.25	\$ 8,426	\$ -	\$ 11,997
TSF-H34	H34-1			\$ -	\$ -	\$ -	\$ -	\$ -	\$ -	\$ -
TSF-H34	H34-2			\$ -	\$ -	\$ -	\$ -	\$ -	\$ -	\$ -
TSF-H35	H35-1			\$ -	\$ -	\$ -	\$ -	\$ -	\$ -	\$ -
TSF-H36	H36-1			\$ -	\$ -	\$ 43,089	\$ -	\$ -	\$ -	\$ 9,695
TSF-H36	H36-2			\$ -	\$ -	\$ 10,862	\$ -	\$ -	\$ -	\$ 2,439
TSF-H37	H37-1			\$ -	\$ -	\$ 6,317	\$ -	\$ -	\$ -	\$ 1,421
TSF-H37	H37-2			\$ -	\$ -	\$ -	\$ -	\$ -	\$ -	\$ -
TSF-H38	H38-1			\$ -	\$ -	\$ -	\$ -	\$ -	\$ -	\$ -
TSF-H39	H39-1			\$ -	\$ -	\$ 19,965	\$ -	\$ -	\$ -	\$ 4,492
TSF-H39	H39-2			\$ -	\$ -	\$ -	\$ -	\$ -	\$ -	\$ -
TSF-H40	H40-1			\$ -	\$ -	\$ -	\$ -	\$ -	\$ -	\$ -
TSF-H40	H40-2			\$ -	\$ -	\$ -	\$ -	\$ -	\$ -	\$ -
TSF-H41	H41-1			\$ -	\$ -	\$ -	\$ -	\$ -	\$ -	\$ -
TSF-H42	H42-1			\$ -	\$ -	\$ 31,027	\$ -	\$ -	\$ -	\$ -
TSF-H43	H43-1			\$ 13,474.29	\$ 9,072	\$ 12,918	\$ 3,031.72	\$ 2,041	\$ -	\$ 6,981
TSF-H43	H43-2			\$ 7,620.83	\$ 10,780	\$ 15,349	\$ 1,714.69	\$ 2,425	\$ -	\$ 2,907
TSF-H43	H43-3			\$ 18,104.76	\$ 17,899	\$ 25,485	\$ 4,073.57	\$ 4,027	\$ -	\$ 5,734
TSF-H44	H44-1			\$ 21,379.20	\$ 13,229	\$ 18,836	\$ 4,810.32	\$ 2,976	\$ -	\$ 4,238
TSF-H44	H44-2			\$ -	\$ -	\$ 39,875	\$ -	\$ -	\$ -	\$ 8,972
TSF-H45	H45-1			\$ 18,870.72	\$ 14,184	\$ 20,196	\$ 4,245.91	\$ 3,191	\$ -	\$ 4,544
TSF-H45	H45-2			\$ 8,400.48	\$ 10,113	\$ 14,399	\$ 1,890.11	\$ 2,275	\$ -	\$ 3,240
TSF-H45	H45-3			\$ 17,151.41	\$ 10,467	\$ 14,903	\$ 3,859.07	\$ 2,355	\$ -	\$ 3,353
TSF-H46	H46-1			\$ -	\$ -	\$ -	\$ -	\$ -	\$ -	\$ -
TSF-H46	H46-2			\$ -	\$ 31,264	\$ 43,590	\$ -	\$ 7,034	\$ -	\$ 9,808
TSF-H47	H47-1			\$ -	\$ -	\$ 35,459	\$ -	\$ -	\$ -	\$ 7,978
TSF-H47	H47-2			\$ -	\$ 24,325	\$ 34,129	\$ -	\$ 5,473	\$ -	\$ 7,679
TSF-H48	H48-1			\$ -	\$ 30,405	\$ 39,789	\$ -	\$ 6,841	\$ -	\$ 8,953
TSF-H48	H48-2			\$ -	\$ 30,870	\$ 47,295	\$ -	\$ 6,946	\$ -	\$ 10,641
TSF-H49	H49-1			\$ 4,086.03	\$ 10,974	\$ 15,625	\$ 919.36	\$ 2,469	\$ -	\$ 3,516
TSF-H50	H50-1			\$ -	\$ 3,700	\$ 10,374	\$ -	\$ 833	\$ -	\$ 2,334
TSF-H51	H51-1			\$ 17,881.36	\$ 11,705	\$ 16,666	\$ 4,023.31	\$ 2,634	\$ -	\$ 3,750

SUBSTATION	CKT	Regulator Cost (\$)		Upgrade Costs By Year (\$)			Total Cost of Upgrades (\$)
		2016 Regulator Upgrade (\$)	2030 Regulator Upgrade (\$)	2016 Total Cost of Upgrades (\$)	2020 Total Cost of Upgrades (\$)	2030 Total Cost of Upgrades (\$)	
Hawaiian Electric							
TSF-H27	H27-1	\$ -	\$ -	\$ -	\$ 41,386	\$ -	\$ 41,386
TSF-H27	H27-2	\$ -	\$ -	\$ -	\$ 12,592	\$ -	\$ 12,592
TSF-H28	H28-1	\$ -	\$ -	\$ -	\$ -	\$ 30,966	\$ 30,966
TSF-H28	H28-2	\$ -	\$ -	\$ -	\$ -	\$ 21,494	\$ 21,494
TSF-H29	H29-1	\$ -	\$ -	\$ -	\$ -	\$ -	\$ -
TSF-H30	H30-1	\$ -	\$ -	\$ -	\$ -	\$ 11,000	\$ 11,000
TSF-H30	H30-2	\$ -	\$ -	\$ -	\$ -	\$ -	\$ -
TSF-H31	H31-1	\$ -	\$ -	\$ -	\$ -	\$ 11,000	\$ 11,000
TSF-H32	H32-1	\$ -	\$ -	\$ -	\$ -	\$ -	\$ -
TSF-H33	H33-1	\$ -	\$ -	\$ -	\$ -	\$ -	\$ -
TSF-H33	H33-2	\$ -	\$ -	\$ 37,018	\$ 45,874	\$ 65,318	\$ 148,209
TSF-H34	H34-1	\$ -	\$ -	\$ -	\$ -	\$ -	\$ -
TSF-H34	H34-2	\$ -	\$ -	\$ -	\$ -	\$ -	\$ -
TSF-H35	H35-1	\$ -	\$ -	\$ -	\$ -	\$ 11,000	\$ 11,000
TSF-H36	H36-1	\$ -	\$ -	\$ -	\$ -	\$ 63,784	\$ 63,784
TSF-H36	H36-2	\$ -	\$ -	\$ -	\$ -	\$ 13,281	\$ 13,281
TSF-H37	H37-1	\$ -	\$ -	\$ -	\$ -	\$ 18,738	\$ 18,738
TSF-H37	H37-2	\$ -	\$ -	\$ -	\$ -	\$ -	\$ -
TSF-H38	H38-1	\$ -	\$ -	\$ -	\$ -	\$ -	\$ -
TSF-H39	H39-1	\$ -	\$ -	\$ -	\$ -	\$ 24,458	\$ 24,458
TSF-H39	H39-2	\$ -	\$ -	\$ -	\$ -	\$ -	\$ -
TSF-H40	H40-1	\$ -	\$ -	\$ -	\$ -	\$ -	\$ -
TSF-H40	H40-2	\$ -	\$ -	\$ -	\$ -	\$ -	\$ -
TSF-H41	H41-1	\$ -	\$ -	\$ -	\$ -	\$ 11,000	\$ 11,000
TSF-H42	H42-1	\$ -	\$ -	\$ -	\$ -	\$ 38,008	\$ 38,008
TSF-H43	H43-1	\$ -	\$ -	\$ 27,506	\$ 11,114	\$ 2,490,824	\$ 2,529,444
TSF-H43	H43-2	\$ -	\$ -	\$ 9,336	\$ 13,205	\$ 18,803	\$ 41,344
TSF-H43	H43-3	\$ 11,000	\$ -	\$ 33,178	\$ 21,926	\$ 31,219	\$ 86,323
TSF-H44	H44-1	\$ -	\$ -	\$ 26,190	\$ 16,205	\$ 23,074	\$ 65,469
TSF-H44	H44-2	\$ -	\$ -	\$ -	\$ -	\$ 48,847	\$ 48,847
TSF-H45	H45-1	\$ -	\$ -	\$ 23,117	\$ 17,375	\$ 2,495,740	\$ 2,540,232
TSF-H45	H45-2	\$ -	\$ -	\$ 10,291	\$ 12,388	\$ 17,639	\$ 40,318
TSF-H45	H45-3	\$ -	\$ -	\$ 21,010	\$ 12,822	\$ 18,256	\$ 52,089
TSF-H46	H46-1	\$ -	\$ -	\$ -	\$ -	\$ 11,000	\$ 11,000
TSF-H46	H46-2	\$ -	\$ -	\$ -	\$ 38,298	\$ 53,398	\$ 91,696
TSF-H47	H47-1	\$ -	\$ -	\$ -	\$ -	\$ 43,437	\$ 43,437
TSF-H47	H47-2	\$ -	\$ -	\$ -	\$ 29,798	\$ 41,807	\$ 71,606
TSF-H48	H48-1	\$ -	\$ -	\$ -	\$ 37,246	\$ 48,742	\$ 85,987
TSF-H48	H48-2	\$ -	\$ -	\$ -	\$ 37,815	\$ 57,936	\$ 95,751
TSF-H49	H49-1	\$ -	\$ -	\$ 16,005	\$ 13,443	\$ 19,141	\$ 48,590
TSF-H50	H50-1	\$ -	\$ 11,000	\$ -	\$ 26,533	\$ 12,708	\$ 39,240
TSF-H51	H51-1	\$ -	\$ -	\$ 32,905	\$ 14,338	\$ 20,416	\$ 67,659

SUBSTATION	CKT	LTC Substation Upgrade (\$)			Reconductor (\$/mile)			Substation Cost (\$)			
		2016 Substation LTC Costs (\$)	2020 Substation LTC Costs (\$)	2030 Substation LTC Costs (\$)	2016 Reconductor (\$)	2020 Reconductor (\$)	2030 Reconductor (\$)	2016 Substation Transformer Upgrade (\$)	2020 Substation Transformer Upgrade (\$)	2030 Substation Transformer Upgrade (\$)	
Hawaiian Electric											
TSF-H51	H51-2	\$ -	\$ -	-	\$ -	\$ -	-	\$ -	\$ -	-	\$ -
TSF-H52	H52-1	\$ 11,000	\$ -	-	\$ -	\$ -	-	\$ -	\$ -	-	\$ -
TSF-H52	H52-2	\$ -	\$ -	-	\$ -	\$ -	-	\$ -	\$ -	-	\$ -
TSF-H52	H52-3	\$ -	\$ -	-	\$ -	\$ -	-	\$ -	\$ -	-	\$ -
TSF-H53	H53-1	\$ -	\$ -	-	\$ -	\$ -	-	\$ -	\$ -	-	\$ -
TSF-H53	H53-2	\$ -	\$ -	-	\$ -	\$ -	-	\$ -	\$ -	-	\$ -
TSF-H54	H54-1	\$ -	\$ -	-	\$ -	\$ -	-	\$ -	\$ -	-	\$ -
TSF-H55	H55-1	\$ -	\$ -	-	\$ -	\$ -	-	\$ -	\$ -	-	\$ -
TSF-H55	H55-2	\$ -	\$ -	-	\$ -	\$ -	-	\$ -	\$ -	-	\$ -
TSF-H55	H55-3	\$ -	\$ -	-	\$ -	\$ -	-	\$ -	\$ -	-	\$ -
TSF-H56	H56-1	\$ -	\$ -	11,000	\$ -	\$ -	-	\$ -	\$ -	-	\$ -
TSF-H57	H57-1	\$ 11,000	\$ -	-	\$ -	\$ -	-	\$ -	\$ -	-	\$ -
TSF-H57	H57-2	\$ -	\$ -	-	\$ -	\$ -	-	\$ -	\$ -	-	\$ -
TSF-H58	H58-1	\$ 11,000	\$ -	-	\$ -	\$ -	-	\$ -	\$ -	-	\$ -
TSF-H59	H59-1	\$ -	\$ -	11,000	\$ -	\$ -	-	\$ -	\$ -	-	\$ -
TSF-H59	H59-2	\$ -	\$ -	-	\$ -	\$ -	-	\$ -	\$ -	-	\$ -
TSF-H60	H60-1	\$ -	\$ 11,000	-	\$ -	\$ -	-	\$ -	\$ -	-	\$ -
TSF-H60	H60-2	\$ -	\$ -	-	\$ -	\$ -	-	\$ -	\$ -	-	\$ -
TSF-H61	H61-1	\$ 11,000	\$ -	-	\$ -	\$ -	-	\$ -	\$ -	-	\$ -
TSF-H61	H61-2	\$ -	\$ -	-	\$ -	\$ -	-	\$ -	\$ -	-	\$ -
TSF-H62	H62-1	\$ -	\$ 11,000	-	\$ -	\$ -	-	\$ -	\$ -	-	\$ -
TSF-H62	H62-2	\$ -	\$ -	-	\$ -	\$ -	-	\$ -	\$ -	-	\$ -
TSF-H63	H63-1	\$ -	\$ -	11,000	\$ -	\$ -	-	\$ -	\$ -	-	\$ -
TSF-H64	H64-1	\$ -	\$ -	-	\$ -	\$ -	-	\$ -	\$ -	-	\$ -
TSF-H64	H64-2	\$ -	\$ -	-	\$ -	\$ -	-	\$ -	\$ -	-	\$ -
TSF-H65	H65-1	\$ -	\$ -	-	\$ -	\$ -	-	\$ -	\$ -	-	\$ -
TSF-H65	H65-2	\$ -	\$ -	-	\$ -	\$ -	-	\$ -	\$ -	-	\$ -
TSF-H66	H66-1	\$ -	\$ -	-	\$ -	\$ -	-	\$ -	\$ -	-	\$ -
TSF-H66	H66-2	\$ -	\$ -	-	\$ -	\$ -	-	\$ -	\$ -	-	\$ -
TSF-H67	H67-1	\$ -	\$ -	-	\$ -	\$ -	-	\$ -	\$ -	-	\$ -
TSF-H67	H67-2	\$ -	\$ -	-	\$ -	\$ -	-	\$ -	\$ -	-	\$ -
TSF-H68	H68-1	\$ -	\$ -	-	\$ -	\$ -	-	\$ -	\$ -	-	\$ -
TSF-H68	H68-2	\$ -	\$ -	-	\$ -	\$ -	-	\$ -	\$ -	-	\$ -
TSF-H69	H69-1	\$ -	\$ -	-	\$ -	\$ -	-	\$ -	\$ -	-	\$ -
TSF-H69	H69-2	\$ -	\$ -	-	\$ -	\$ -	-	\$ -	\$ -	-	\$ -
TSF-H70	H70-1	\$ -	\$ -	-	\$ -	\$ -	-	\$ -	\$ -	-	\$ -
TSF-H70	H70-2	\$ -	\$ -	-	\$ -	\$ -	-	\$ -	\$ -	-	\$ -
TSF-H71	H71-1	\$ -	\$ -	-	\$ -	\$ -	-	\$ -	\$ -	-	\$ -
TSF-H71	H71-2	\$ -	\$ -	-	\$ -	\$ -	-	\$ -	\$ -	-	\$ -
TSF-H72	H72-1	\$ -	\$ -	-	\$ -	\$ -	-	\$ -	\$ -	-	\$ -
TSF-H72	H72-2	\$ -	\$ -	-	\$ -	\$ -	-	\$ -	\$ -	-	\$ -
TSF-H73	H73-1	\$ -	\$ 11,000	-	\$ -	\$ -	-	\$ -	\$ -	-	\$ -

SUBSTATION	CKT	Grounding Transformer Cost (\$)		Distribution Transformer Cost (\$)		Pole and Secondary Cost (\$)			
		2016 Grounding Xfmr Addition (\$)	2030 Grounding Xfmr Addition (\$)	2016 Distribution Xfmr Upgrade (\$)	2020 Distribution Xfmr Upgrade (\$)	2030 Distribution Xfmr Upgrade (\$)	2016 Distribution Xfmr Upgrade (\$)	2020 Distribution Xfmr Upgrade (\$)	2030 Distribution Xfmr Upgrade (\$)
Hawaiian Electric									
TSF-H51	H51-2			4,504.97	5,307	7,556	1,013.62	1,194	1,700
TSF-H52	H52-1			4,258.45	3,114	4,434	958.15	701	998
TSF-H52	H52-2			6,629.67	8,787	12,511	1,491.68	1,977	2,815
TSF-H52	H52-3								
TSF-H53	H53-1								
TSF-H53	H53-2								
TSF-H54	H54-1								
TSF-H55	H55-1								
TSF-H55	H55-2								
TSF-H55	H55-3								
TSF-H56	H56-1								
TSF-H57	H57-1			24,469.37	18,447	26,266	5,505.61	4,151	5,910
TSF-H57	H57-2			7,020.31	10,369	14,765	1,579.57	2,333	3,322
TSF-H58	H58-1			24,864.31	15,490	22,056	5,594.47	3,485	4,963
TSF-H59	H59-1								
TSF-H59	H59-2					1,550			349
TSF-H60	H60-1								
TSF-H60	H60-2								
TSF-H61	H61-1			45,305.51	41,808	59,528	10,193.74	9,407	13,394
TSF-H61	H61-2			34,696.17	24,907	35,465	7,806.64	5,604	7,980
TSF-H62	H62-1				5,700	10,601		1,282	2,385
TSF-H62	H62-2								
TSF-H63	H63-1					4,090			920
TSF-H64	H64-1								
TSF-H64	H64-2			30,629.19	24,281	34,573	6,891.57	5,463	7,779
TSF-H65	H65-1								
TSF-H65	H65-2			38,179.56	24,332	34,645	8,590.40	5,475	7,795
TSF-H66	H66-1			46,302.22	27,071	38,546	10,418.00	6,091	8,673
TSF-H66	H66-2				8,366	17,335		1,882	3,900
TSF-H67	H67-1								
TSF-H67	H67-2								
TSF-H68	H68-1				37,217	57,768		8,374	12,998
TSF-H68	H68-2			8,499.01	19,329	27,522	1,912.28	4,949	6,192
TSF-H69	H69-1				26,892	48,183		6,051	10,841
TSF-H69	H69-2								
TSF-H70	H70-1				18,175	24,987		4,089	5,622
TSF-H70	H70-2								
TSF-H71	H71-1								
TSF-H71	H71-2			37,060.28	43,708	62,235	8,338.56	9,834	14,003
TSF-H72	H72-1								
TSF-H72	H72-2								
TSF-H73	H73-1				26,912	48,059		6,055	10,813

SUBSTATION	CKT	Regulator Cost (\$)		Upgrade Costs By Year (\$)			Total Cost of Upgrades (\$)
		2016 Regulator Upgrade (\$)	2030 Regulator Upgrade (\$)	2016 Total Cost of Upgrades (\$)	2020 Total Cost of Upgrades (\$)	2030 Total Cost of Upgrades (\$)	
Hawaiian Electric							
TSF-H51	H51-2	\$ -	\$ -	\$ 5,519	\$ 6,501	\$ 9,256	\$ 21,276
TSF-H52	H52-1	\$ -	\$ -	\$ 16,217	\$ 3,814	\$ 5,431	\$ 25,462
TSF-H52	H52-2	\$ -	\$ -	\$ 8,121	\$ 10,764	\$ 15,326	\$ 34,211
TSF-H52	H52-3	\$ -	\$ -	\$ -	\$ -	\$ -	\$ -
TSF-H53	H53-1	\$ -	\$ -	\$ -	\$ -	\$ -	\$ -
TSF-H53	H53-2	\$ -	\$ -	\$ -	\$ -	\$ -	\$ -
TSF-H54	H54-1	\$ -	\$ -	\$ -	\$ -	\$ -	\$ -
TSF-H55	H55-1	\$ -	\$ -	\$ -	\$ -	\$ -	\$ -
TSF-H55	H55-2	\$ -	\$ -	\$ -	\$ -	\$ -	\$ -
TSF-H55	H55-3	\$ -	\$ -	\$ -	\$ -	\$ -	\$ -
TSF-H56	H56-1	\$ -	\$ -	\$ -	\$ -	\$ 11,000	\$ 11,000
TSF-H57	H57-1	\$ -	\$ -	\$ 40,975	\$ 22,598	\$ 2,507,176	\$ 2,570,749
TSF-H57	H57-2	\$ -	\$ -	\$ 8,600	\$ 12,702	\$ 18,087	\$ 39,389
TSF-H58	H58-1	\$ -	\$ -	\$ 41,459	\$ 18,975	\$ 2,502,018	\$ 2,562,452
TSF-H59	H59-1	\$ -	\$ -	\$ -	\$ -	\$ 11,000	\$ 11,000
TSF-H59	H59-2	\$ -	\$ -	\$ -	\$ -	\$ 1,899	\$ 1,899
TSF-H60	H60-1	\$ -	\$ -	\$ -	\$ 11,000	\$ -	\$ 11,000
TSF-H60	H60-2	\$ -	\$ -	\$ -	\$ -	\$ -	\$ -
TSF-H61	H61-1	\$ -	\$ -	\$ 66,499	\$ 51,214	\$ 2,547,922	\$ 2,665,636
TSF-H61	H61-2	\$ -	\$ -	\$ 42,503	\$ 30,511	\$ 43,444	\$ 116,459
TSF-H62	H62-1	\$ -	\$ -	\$ -	\$ 17,982	\$ 12,987	\$ 30,969
TSF-H62	H62-2	\$ -	\$ -	\$ -	\$ -	\$ -	\$ -
TSF-H63	H63-1	\$ -	\$ -	\$ -	\$ -	\$ 16,010	\$ 16,010
TSF-H64	H64-1	\$ -	\$ -	\$ -	\$ -	\$ -	\$ -
TSF-H64	H64-2	\$ -	\$ -	\$ 37,521	\$ 29,744	\$ 42,352	\$ 109,616
TSF-H65	H65-1	\$ -	\$ -	\$ -	\$ -	\$ -	\$ -
TSF-H65	H65-2	\$ -	\$ -	\$ 46,770	\$ 29,806	\$ 42,440	\$ 119,016
TSF-H66	H66-1	\$ -	\$ -	\$ 56,720	\$ 33,162	\$ 47,218	\$ 137,101
TSF-H66	H66-2	\$ -	\$ -	\$ -	\$ 10,248	\$ 21,235	\$ 31,483
TSF-H67	H67-1	\$ -	\$ -	\$ -	\$ -	\$ -	\$ -
TSF-H67	H67-2	\$ -	\$ -	\$ -	\$ -	\$ -	\$ -
TSF-H68	H68-1	\$ -	\$ -	\$ -	\$ 45,591	\$ 70,766	\$ 116,357
TSF-H68	H68-2	\$ -	\$ -	\$ 10,411	\$ 23,678	\$ 33,714	\$ 67,803
TSF-H69	H69-1	\$ -	\$ -	\$ -	\$ 32,943	\$ 59,024	\$ 91,967
TSF-H69	H69-2	\$ -	\$ -	\$ -	\$ -	\$ -	\$ -
TSF-H70	H70-1	\$ -	\$ -	\$ -	\$ 22,265	\$ 30,609	\$ 52,873
TSF-H70	H70-2	\$ -	\$ -	\$ -	\$ -	\$ -	\$ -
TSF-H71	H71-1	\$ -	\$ -	\$ -	\$ -	\$ -	\$ -
TSF-H71	H71-2	\$ -	\$ -	\$ 45,399	\$ 53,543	\$ 76,238	\$ 175,179
TSF-H72	H72-1	\$ -	\$ -	\$ -	\$ -	\$ -	\$ -
TSF-H72	H72-2	\$ -	\$ -	\$ -	\$ -	\$ -	\$ -
TSF-H73	H73-1	\$ -	\$ -	\$ -	\$ 43,967	\$ 58,872	\$ 102,839

SUBSTATION	CKT	Grounding Transformer Cost (\$)		Distribution Transformer Cost (\$)		Pole and Secondary Cost (\$)					
		2016 Grounding Xfmr Addition (\$)	2030 Grounding Xfmr Addition (\$)	2016 Distribution Xfmr Upgrade (\$)	2020 Distribution Xfmr Upgrade (\$)	2030 Distribution Xfmr Upgrade (\$)	2016 Distribution Xfmr Upgrade (\$)	2020 Distribution Xfmr Upgrade (\$)	2030 Distribution Xfmr Upgrade (\$)		
Hawaiian Electric											
TSF-H73	H73-2										
TSF-H74	H74-1			26,845	34,177					6,040	7,690
TSF-H75	H75-1										
TSF-H76	H76-1										
TSF-H77	H77-1										
TSF-H78	H78-1										
TSF-H79	H79-1										
TSF-H79	H79-2										
TSF-H80	H80-1										
TSF-H80	H80-2			14,944	50,817					3,362	11,434
TSF-H81	H81-1			27,376	38,979			4,142.39		6,160	8,770
TSF-H81	H81-2				38,557						8,675
TSF-H82	H82-1										
TSF-H82	H82-2										
TSF-H83	H83-1			10,873	14,463					2,446	3,254
TSF-H83	H83-2										
TSF-H83	H83-3			2,813.65	1,622	2,310		633.07		365	520
TSF-H84	H84-1										
TSF-H84	H84-2			17,673	40,603					3,976	9,136
TSF-H85	H85-1										
TSF-H85	H85-2										
TSF-H86	H86-1			8,756.46	8,153	5,726		1,970.20		1,288	1,834
TSF-H87	H87-1										
TSF-H88	H88-1				19,972						4,494
TSF-H89	H89-1										
TSF-H89	H89-2										
TSF-H90	H90-1										
TSF-H91	H91-1			34,113.66	58,019	40,748		7,675.57		9,168	13,054
TSF-H91	H91-2			50,661.06	59,052	41,473		11,398.74		9,331	13,287
TSF-H92	H92-1			57,521.88	71,877	50,480		12,942.42		11,358	16,172
TSF-H92	H92-2				33,649	16,785				3,777	7,571
TSF-H93	H93-1										
TSF-H94	H94-1										
TSF-H95	H95-1										
TSF-H95	H95-2										
TSF-H96	H96-1										
TSF-H97	H97-1			49,198.45	59,550	41,808		11,060.65		9,407	13,394
TSF-H97	H97-2			23,522.29	61,462	43,166		5,292.51		9,712	13,829
TSF-H98	H98-1				32,791	22,535				5,070	7,378
TSF-H98	H98-2										
TSF-H99	H99-1			43,428.04	56,619	39,764		9,771.31		8,947	12,739
TSF-H99	H99-2			8,284.82	35,746	25,105		1,864.09		5,649	8,043

#VALUE!

#VALUE!

#VALUE!

SUBSTATION	CKT	Regulator Cost (\$)		Upgrade Costs By Year (\$)			Total Cost of Upgrades (\$)
		2016 Regulator Upgrade (\$)	2030 Regulator Upgrade (\$)	2016 Total Cost of Upgrades (\$)	2020 Total Cost of Upgrades (\$)	2030 Total Cost of Upgrades (\$)	
Hawaiian Electric							
TSF-H73	H73-2	\$ -	\$ -	\$ -	\$ -	\$ -	\$ -
TSF-H74	H74-1	\$ -	\$ -	\$ 11,000	\$ 32,885	\$ 41,867	\$ 85,752
TSF-H75	H75-1	\$ -	\$ -	\$ -	\$ -	\$ -	\$ -
TSF-H76	H76-1	\$ -	\$ -	\$ -	\$ -	\$ -	\$ -
TSF-H77	H77-1	\$ -	\$ -	\$ -	\$ -	\$ -	\$ -
TSF-H78	H78-1	\$ -	\$ -	\$ -	\$ -	\$ -	\$ -
TSF-H79	H79-1	\$ -	\$ -	\$ -	\$ -	\$ -	\$ -
TSF-H79	H79-2	\$ -	\$ -	\$ -	\$ -	\$ -	\$ -
TSF-H80	H80-1	\$ -	\$ -	\$ -	\$ -	\$ -	\$ -
TSF-H80	H80-2	\$ -	\$ -	\$ -	\$ 18,307	\$ 62,251	\$ 80,558
TSF-H81	H81-1	\$ -	\$ -	\$ 22,553	\$ 33,535	\$ 47,750	\$ 103,838
TSF-H81	H81-2	\$ -	\$ -	\$ -	\$ -	\$ 47,232	\$ 47,232
TSF-H82	H82-1	\$ -	\$ -	\$ -	\$ -	\$ -	\$ -
TSF-H82	H82-2	\$ -	\$ -	\$ -	\$ -	\$ -	\$ -
TSF-H83	H83-1	\$ -	\$ -	\$ -	\$ 24,319	\$ 17,717	\$ 42,036
TSF-H83	H83-2	\$ -	\$ -	\$ -	\$ -	\$ -	\$ -
TSF-H83	H83-3	\$ -	\$ -	\$ 3,447	\$ 1,987	\$ 2,829	\$ 8,263
TSF-H84	H84-1	\$ -	\$ -	\$ -	\$ -	\$ -	\$ -
TSF-H84	H84-2	\$ -	\$ -	\$ -	\$ 21,649	\$ 49,738	\$ 71,387
TSF-H85	H85-1	\$ -	\$ -	\$ -	\$ -	\$ 11,000	\$ 11,000
TSF-H85	H85-2	\$ -	\$ -	\$ -	\$ -	\$ -	\$ -
TSF-H86	H86-1	\$ -	\$ -	\$ 10,727	\$ 7,014	\$ 9,987	\$ 27,727
TSF-H87	H87-1	\$ -	\$ -	\$ -	\$ -	\$ -	\$ -
TSF-H88	H88-1	\$ -	\$ -	\$ -	\$ -	\$ 24,466	\$ 24,466
TSF-H89	H89-1	\$ -	\$ -	\$ -	\$ -	\$ -	\$ -
TSF-H89	H89-2	\$ -	\$ -	\$ -	\$ -	\$ -	\$ -
TSF-H90	H90-1	\$ -	\$ -	\$ -	\$ -	\$ -	\$ -
TSF-H91	H91-1	\$ -	\$ -	\$ 41,789	\$ 49,916	\$ 2,546,074	\$ 2,637,779
TSF-H91	H91-2	\$ -	\$ -	\$ 62,060	\$ 50,804	\$ 72,339	\$ 185,203
TSF-H92	H92-1	\$ -	\$ -	\$ 70,464	\$ 61,838	\$ 2,563,049	\$ 2,695,351
TSF-H92	H92-2	\$ -	\$ -	\$ -	\$ 20,562	\$ 41,219	\$ 61,782
TSF-H93	H93-1	\$ -	\$ -	\$ -	\$ -	\$ -	\$ -
TSF-H94	H94-1	\$ -	\$ -	\$ -	\$ -	\$ -	\$ -
TSF-H95	H95-1	\$ -	\$ -	\$ -	\$ -	\$ -	\$ -
TSF-H95	H95-2	\$ -	\$ -	\$ -	\$ -	\$ -	\$ -
TSF-H96	H96-1	\$ -	\$ -	\$ -	\$ -	\$ -	\$ -
TSF-H97	H97-1	\$ -	\$ -	\$ 60,268	\$ 51,215	\$ 2,547,924	\$ 2,659,407
TSF-H97	H97-2	\$ -	\$ -	\$ 28,815	\$ 52,878	\$ 75,291	\$ 156,984
TSF-H98	H98-1	\$ -	\$ -	\$ -	\$ 27,606	\$ 51,169	\$ 78,774
TSF-H98	H98-2	\$ -	\$ -	\$ -	\$ -	\$ 11,000	\$ 11,000
TSF-H99	H99-1	\$ -	\$ -	\$ 64,199	\$ 48,711	\$ 69,358	\$ 182,269
TSF-H99	H99-2	\$ -	\$ -	\$ 10,149	\$ 30,753	\$ 43,789	\$ 84,691

SUBSTATION	CKT	LTC Substation Upgrade (\$)			Reconductor (\$/mile)			Substation Cost (\$)			
		2016 Substation LTC Costs (\$)	2020 Substation LTC Costs (\$)	2030 Substation LTC Costs (\$)	2016 Reconductor (\$)	2020 Reconductor (\$)	2030 Reconductor (\$)	2016 Substation Transformer Upgrade (\$)	2020 Substation Transformer Upgrade (\$)	2030 Substation Transformer Upgrade (\$)	
Hawaiian Electric											
TSF-H100	H100-1	\$ -	\$ -	-	\$ -	\$ -	-	\$ -	\$ -	-	\$ -
TSF-H101	H101-1	\$ -	\$ -	-	\$ -	\$ -	-	\$ -	\$ -	-	\$ -
TSF-H102	H102-1	\$ -	\$ -	-	\$ -	\$ -	-	\$ -	\$ -	-	\$ -
TSF-H103	H103-1	\$ 11,000	\$ -	-	\$ -	\$ -	-	\$ -	\$ -	-	\$ -
TSF-H103	H103-2	\$ -	\$ -	-	\$ -	\$ -	-	\$ -	\$ -	-	\$ -
TSF-H104	H104-1	\$ 11,000	\$ -	-	\$ -	\$ -	-	\$ -	\$ -	-	\$ -
TSF-H104	H104-2	\$ -	\$ -	-	\$ -	\$ -	-	\$ -	\$ -	-	\$ -
TSF-H105	H105-1	\$ -	\$ -	11,000	\$ -	\$ -	-	\$ -	\$ -	-	\$ -
TSF-H106	H106-1	\$ -	\$ 11,000	-	\$ -	\$ -	-	\$ -	\$ -	-	\$ -
TSF-H106	H106-2	\$ -	\$ -	-	\$ -	\$ -	-	\$ -	\$ -	-	\$ -
TSF-H107	H107-1	\$ -	\$ -	-	\$ -	\$ -	-	\$ -	\$ -	-	\$ -
TSF-H107	H107-2	\$ -	\$ -	-	\$ -	\$ -	-	\$ -	\$ -	-	\$ -
TSF-H108	H108-1	\$ -	\$ -	-	\$ -	\$ -	-	\$ -	\$ -	-	\$ -
TSF-H108	H108-2	\$ -	\$ -	-	\$ -	\$ -	-	\$ -	\$ -	-	\$ -
TSF-H109	H109-1	\$ -	\$ -	11,000	\$ -	\$ -	-	\$ -	\$ -	-	\$ -
TSF-H109	H109-2	\$ -	\$ -	-	\$ -	\$ -	-	\$ -	\$ -	-	\$ -
TSF-H110	H110-1	\$ -	\$ -	11,000	\$ -	\$ -	-	\$ -	\$ -	-	\$ -
TSF-H111	H111-1	\$ -	\$ -	11,000	\$ -	\$ -	-	\$ -	\$ -	-	\$ -
TSF-H111	H111-2	\$ -	\$ -	-	\$ -	\$ -	-	\$ -	\$ -	-	\$ -
TSF-H112	H112-1	\$ 11,000	\$ -	-	\$ -	\$ -	-	\$ -	\$ -	-	\$ -
TSF-H112	H112-2	\$ -	\$ -	-	\$ -	\$ -	-	\$ -	\$ -	-	\$ -
TSF-H113	H113-1	\$ -	\$ -	-	\$ -	\$ -	-	\$ -	\$ -	-	\$ -
TSF-H113	H113-2	\$ -	\$ -	-	\$ -	\$ -	-	\$ -	\$ -	-	\$ -
TSF-H114	H114-1	\$ -	\$ 11,000	-	\$ -	\$ -	-	\$ -	\$ -	-	\$ -
TSF-H114	H114-2	\$ -	\$ -	-	\$ -	\$ -	-	\$ -	\$ -	-	\$ -
TSF-H115	H115-1	\$ -	\$ -	-	\$ -	\$ -	-	\$ -	\$ -	-	\$ -
TSF-H115	H115-2	\$ -	\$ -	-	\$ -	\$ -	-	\$ -	\$ -	-	\$ -
TSF-H116	H116-1	\$ -	\$ -	-	\$ -	\$ -	-	\$ -	\$ -	-	\$ -
TSF-H116	H116-2	\$ -	\$ -	-	\$ -	\$ -	-	\$ -	\$ -	-	\$ -
TSF-H117	H117-1	\$ -	\$ -	-	\$ -	\$ -	-	\$ -	\$ -	-	\$ -
TSF-H118	H118-1	\$ -	\$ -	-	\$ -	\$ -	-	\$ -	\$ -	-	\$ -
TSF-H118	H118-2	\$ -	\$ -	-	\$ -	\$ -	-	\$ -	\$ -	-	\$ -
TSF-H119	H119-1	\$ -	\$ -	-	\$ -	\$ -	-	\$ -	\$ -	-	\$ -
TSF-H119	H119-2	\$ -	\$ -	-	\$ -	\$ -	-	\$ -	\$ -	-	\$ -
TSF-H120	H120-1	\$ -	\$ -	-	\$ -	\$ -	-	\$ -	\$ -	-	\$ -
TSF-H121	H121-1	\$ -	\$ -	-	\$ -	\$ -	-	\$ -	\$ -	-	\$ -
TSF-H122	H122-1	\$ -	\$ -	-	\$ -	\$ -	-	\$ -	\$ -	-	\$ -
TSF-H123	H123-1	\$ -	\$ -	-	\$ -	\$ -	-	\$ -	\$ -	-	\$ -
TSF-H124	H124-1	\$ -	\$ -	11,000	\$ -	\$ -	-	\$ -	\$ -	-	\$ -
TSF-H125	H125-1	\$ 11,000	\$ -	-	\$ -	\$ -	-	\$ -	\$ -	-	\$ -
TSF-H126	H126-1	\$ -	\$ -	-	\$ -	\$ -	-	\$ -	\$ -	-	\$ -
TSF-H126	H126-2	\$ -	\$ -	-	\$ -	\$ -	-	\$ -	\$ -	-	\$ -

2,475,000

SUBSTATION	CKT	Grounding Transformer Cost (\$)		Distribution Transformer Cost (\$)		Pole and Secondary Cost (\$)	
		2016 Grounding Xfmr Addition (\$)	2030 Grounding Xfmr Addition (\$)	2016 Distribution Xfmr Upgrade (\$)	2030 Distribution Xfmr Upgrade (\$)	2016 Distribution Xfmr Upgrade (\$)	2030 Distribution Xfmr Upgrade (\$)
Hawaiian Electric							
TSF-H127	H127-1			\$ -	\$ -	\$ 15,409	\$ -
TSF-H127	H127-2			\$ -	\$ -	\$ -	\$ -
TSF-H128	H128-1			\$ -	\$ -	\$ -	\$ -
TSF-H128	H128-2			\$ -	\$ -	\$ -	\$ -
TSF-H129	H129-1			\$ -	\$ -	\$ -	\$ -
TSF-H130	H130-1			\$ -	\$ -	\$ -	\$ -
TSF-H130	H130-2			\$ -	\$ -	\$ -	\$ -
TSF-H131	H131-1			\$ -	\$ -	\$ -	\$ -
TSF-H132	H132-1			\$ 79,057.85	\$ 54,115	\$ 77,053	\$ 17,788.02
TSF-H132	H132-2			\$ -	\$ 19,047	\$ 24,958	\$ -
TSF-H133	H133-1			\$ 23,757.03	\$ 49,331	\$ 70,241	\$ 5,345.33
TSF-H134	H134-1			\$ 39,360.99	\$ 34,931	\$ 49,737	\$ 8,856.22
TSF-H134	H134-2			\$ -	\$ -	\$ 23,030	\$ -
TSF-H135	H135-1			\$ -	\$ -	\$ -	\$ -
TSF-H135	H135-2			\$ 32,503.80	\$ 42,306	\$ 60,238	\$ 7,313.36
TSF-H136	H136-1			\$ -	\$ -	\$ -	\$ -
TSF-H136	H136-2			\$ -	\$ -	\$ -	\$ -
TSF-H137	H137-1			\$ -	\$ -	\$ -	\$ -
TSF-H138	H138-1			\$ -	\$ -	\$ 31,530	\$ -
TSF-H139	H139-1			\$ 12,886.13	\$ 18,465	\$ 26,292	\$ 2,899.38
TSF-H140	H140-1			\$ -	\$ 12,075	\$ 52,078	\$ -
TSF-H140	H140-2			\$ 70,791.90	\$ 31,621	\$ 45,024	\$ 15,928.18
TSF-H141	H141-1			\$ 15,266.05	\$ 28,929	\$ 41,191	\$ 3,434.86
TSF-H141	H141-2			\$ 24,963.08	\$ 29,247	\$ 41,644	\$ 5,616.69
TSF-H141	H141-3			\$ 19,490.43	\$ 9,859	\$ 14,039	\$ 4,385.35
TSF-H142	H142-1			\$ 11,606.37	\$ 17,278	\$ 24,602	\$ 2,611.43
TSF-H142	H142-2			\$ -	\$ 16,473	\$ 55,292	\$ -
TSF-H143	H143-1			\$ -	\$ 24,437	\$ 32,795	\$ -
TSF-H143	H143-2			\$ -	\$ -	\$ -	\$ -
TSF-H144	H144-1			\$ -	\$ -	\$ -	\$ -
TSF-H144	H144-2			\$ -	\$ -	\$ -	\$ -
TSF-H145	H145-1			\$ -	\$ -	\$ -	\$ -
TSF-H145	H145-2			\$ -	\$ -	\$ -	\$ -
TSF-H146	H146-1			\$ -	\$ -	\$ -	\$ -
TSF-H146	H146-2			\$ -	\$ -	\$ 10,782	\$ -
TSF-H147	H147-1			\$ -	\$ -	\$ -	\$ -
TSF-H147	H147-2			\$ -	\$ -	\$ 18,206	\$ -
TSF-H148	H148-1			\$ -	\$ -	\$ 19,096	\$ -
TSF-H148	H148-2			\$ 52,076.60	\$ 36,638	\$ 52,167	\$ 11,717.23
TSF-H149	H149-1			\$ 45,259.34	\$ 33,269	\$ 47,370	\$ 10,183.35
TSF-H149	H149-2			\$ 9,429.62	\$ 31,112	\$ 44,299	\$ 2,121.66
TSF-H150	H150-1			\$ -	\$ -	\$ 35,302	\$ -
TSF-H150	H150-2			\$ 49,178.28	\$ 57,881	\$ 82,414	\$ 11,065.11

SUBSTATION	CKT	Regulator Cost (\$)		Upgrade Costs By Year (\$)			Total Cost of Upgrades (\$)
		2016 Regulator Upgrade (\$)	2030 Regulator Upgrade (\$)	2016 Total Cost of Upgrades (\$)	2020 Total Cost of Upgrades (\$)	2030 Total Cost of Upgrades (\$)	
Hawaiian Electric							
TSF-H127	H127-1	\$ -	\$ -	\$ -	\$ -	\$ 29,876	\$ 29,876
TSF-H127	H127-2	\$ -	\$ -	\$ -	\$ -	\$ -	\$ -
TSF-H128	H128-1	\$ -	\$ -	\$ -	\$ -	\$ -	\$ -
TSF-H128	H128-2	\$ -	\$ -	\$ -	\$ -	\$ -	\$ -
TSF-H129	H129-1	\$ -	\$ -	\$ -	\$ -	\$ -	\$ -
TSF-H130	H130-1	\$ -	\$ -	\$ -	\$ -	\$ -	\$ -
TSF-H130	H130-2	\$ -	\$ -	\$ -	\$ -	\$ -	\$ -
TSF-H131	H131-1	\$ -	\$ -	\$ -	\$ -	\$ -	\$ -
TSF-H132	H132-1	\$ -	\$ -	\$ 96,846	\$ 66,291	\$ 2,569,389	\$ 2,732,526
TSF-H132	H132-2	\$ -	\$ -	\$ -	\$ 23,333	\$ 30,574	\$ 53,907
TSF-H133	H133-1	\$ -	\$ -	\$ 29,102	\$ 60,431	\$ 86,045	\$ 175,578
TSF-H134	H134-1	\$ -	\$ -	\$ 48,217	\$ 42,790	\$ 60,928	\$ 151,935
TSF-H134	H134-2	\$ -	\$ -	\$ -	\$ -	\$ 28,212	\$ 28,212
TSF-H135	H135-1	\$ -	\$ -	\$ -	\$ -	\$ -	\$ -
TSF-H135	H135-2	\$ -	\$ -	\$ 39,817	\$ 51,825	\$ 73,792	\$ 165,434
TSF-H136	H136-1	\$ -	\$ -	\$ -	\$ -	\$ -	\$ -
TSF-H136	H136-2	\$ -	\$ -	\$ -	\$ -	\$ -	\$ -
TSF-H137	H137-1	\$ -	\$ -	\$ -	\$ 11,000	\$ 38,625	\$ 49,625
TSF-H138	H138-1	\$ -	\$ -	\$ 26,786	\$ 22,620	\$ 32,208	\$ 81,614
TSF-H139	H139-1	\$ -	\$ -	\$ -	\$ 25,792	\$ 63,795	\$ 89,587
TSF-H140	H140-1	\$ -	\$ -	\$ 86,720	\$ 38,736	\$ 2,530,155	\$ 2,655,611
TSF-H140	H140-2	\$ -	\$ -	\$ 18,701	\$ 35,438	\$ 50,459	\$ 104,599
TSF-H141	H141-1	\$ -	\$ -	\$ 30,580	\$ 35,828	\$ 51,014	\$ 117,422
TSF-H141	H141-2	\$ -	\$ -	\$ 23,876	\$ 12,078	\$ 17,197	\$ 53,151
TSF-H142	H142-1	\$ -	\$ -	\$ 14,218	\$ 21,166	\$ 30,137	\$ 65,520
TSF-H142	H142-2	\$ -	\$ -	\$ -	\$ 20,179	\$ 67,732	\$ 87,912
TSF-H143	H143-1	\$ -	\$ -	\$ -	\$ 29,936	\$ 40,162	\$ 70,098
TSF-H143	H143-2	\$ -	\$ -	\$ -	\$ -	\$ -	\$ -
TSF-H144	H144-1	\$ -	\$ -	\$ -	\$ -	\$ -	\$ -
TSF-H144	H144-2	\$ -	\$ -	\$ -	\$ -	\$ -	\$ -
TSF-H145	H145-1	\$ -	\$ -	\$ -	\$ -	\$ -	\$ -
TSF-H145	H145-2	\$ -	\$ -	\$ -	\$ -	\$ -	\$ -
TSF-H146	H146-1	\$ -	\$ -	\$ -	\$ -	\$ -	\$ -
TSF-H146	H146-2	\$ -	\$ -	\$ -	\$ -	\$ 13,208	\$ 13,208
TSF-H147	H147-1	\$ -	\$ -	\$ -	\$ -	\$ -	\$ -
TSF-H147	H147-2	\$ -	\$ -	\$ -	\$ -	\$ 22,302	\$ 22,302
TSF-H148	H148-1	\$ -	\$ -	\$ -	\$ -	\$ 23,393	\$ 23,393
TSF-H148	H148-2	\$ -	\$ -	\$ 63,794	\$ 44,881	\$ 63,905	\$ 172,580
TSF-H149	H149-1	\$ -	\$ -	\$ 66,443	\$ 40,754	\$ 58,028	\$ 165,225
TSF-H149	H149-2	\$ -	\$ -	\$ 11,551	\$ 38,112	\$ 54,267	\$ 103,930
TSF-H150	H150-1	\$ -	\$ -	\$ -	\$ -	\$ 2,518,245	\$ 2,518,245
TSF-H150	H150-2	\$ -	\$ -	\$ 60,243	\$ 70,904	\$ 100,958	\$ 232,105

SUBSTATION	CKT	Grounding Transformer Cost (\$)		Distribution Transformer Cost (\$)		Pole and Secondary Cost (\$)				
		2016 Grounding Xfmr Addition (\$)	2030 Grounding Xfmr Addition (\$)	2016 Distribution Xfmr Upgrade (\$)	2030 Distribution Xfmr Upgrade (\$)	2016 Distribution Xfmr Upgrade (\$)	2020 Distribution Xfmr Upgrade (\$)	2030 Distribution Xfmr Upgrade (\$)		
Hawaiian Electric										
TSF-H151	H151-1			6,014.92	4,643	6,611		1,353.36	1,045	1,487
TSF-H151	H151-2			6,582.98	11,553	16,450		1,481.17	2,599	3,701
TSF-H152	H152-1			6,399.01	8,957	12,753		1,439.78	2,015	2,869
TSF-H152	H152-2			-	-	-		-	-	-
TSF-H153	H153-1			26,708.37	34,016	48,434		6,009.38	7,654	10,898
TSF-H153	H153-2			24,679.77	12,335	17,564		5,552.95	2,775	3,952
TSF-H154	H154-1			-	-	-		-	-	-
TSF-H155	H155-1			-	-	-		-	-	-
TSF-H155	H155-2			-	-	-		-	-	-
TSF-H156	H156-1			-	-	-		-	-	-
TSF-H156	H156-2			-	-	-		-	-	-
TSF-H157	H157-1			-	-	-		-	-	-
TSF-H157	H157-2			-	-	-		-	-	-
TSF-H157	H157-3			-	-	-		-	-	-
TSF-H158	H158-1			15,973.46	33,563	47,789		3,594.03	7,552	10,752
TSF-H158	H158-2			98,724.50	94,279	134,282		22,213.01	21,213	30,204
TSF-H159	H159-1			6,436.33	11,207	15,957		1,448.17	2,521	3,590
TSF-H159	H159-2			148,197.44	85,553	121,816		33,344.42	19,249	27,409
TSF-H160	H160-1			47,346.91	52,027	74,079		10,653.06	11,706	16,668
TSF-H160	H160-2			21,166.38	14,934	21,264		4,762.44	3,360	4,784
TSF-H161	H161-1			79,507.50	56,010	79,751		17,889.19	12,602	17,944
TSF-H161	H161-2			-	-	-		-	-	-
TSF-H162	H162-1			-	-	-		-	-	-
TSF-H162	H162-2			-	-	-		-	-	-
TSF-H163	H163-1			-	-	-		-	-	-
TSF-H164	H164-1			-	-	-		-	-	-
TSF-H164	H164-2			-	-	-		-	-	-
TSF-H165	H165-1			-	-	-		-	-	-
TSF-H165	H165-2			-	-	-		-	-	-
TSF-H166	H166-1			17,904.92	40,116	57,119		4,028.61	9,026	12,852
TSF-H166	H166-2			-	-	-		-	-	-
TSF-H167	H167-1			13,032.48	11,713	16,678		2,932.31	2,635	3,752
TSF-H168	H168-1			18,860.63	17,081	24,321		4,243.64	3,843	5,472
TSF-H169	H169-1			-	-	-		-	-	-
TSF-H170	H170-1			-	-	-		-	-	-
TSF-H170	H170-2			-	-	-		-	-	-
TSF-H171	H171-1			32,219.95	43,321	61,683		7,249.49	9,747	13,879
TSF-H171	H171-2			-	-	-		-	-	-
TSF-H172	H172-1			-	-	-		-	-	-
TSF-H172	H172-2			13,358.31	28,598	40,719		3,005.62	6,434	9,162
TSF-H173	H173-1			-	-	-		-	-	-
TSF-H173	H173-2			-	-	-		-	-	-

SUBSTATION	CKT	Regulator Cost (\$)			Upgrade Costs By Year (\$)			Total Cost of Upgrades (\$)
		2016 Regulator Upgrade (\$)	2020 Regulator Upgrade (\$)	2030 Regulator Upgrade (\$)	2016 Total Cost of Upgrades (\$)	2020 Total Cost of Upgrades (\$)	2030 Total Cost of Upgrades (\$)	
Hawaiian Electric								
TSF-H151	H151-1	\$ -	\$ -	\$ -	\$ 18,368	\$ 5,688	\$ 8,098	\$ 32,154
TSF-H151	H151-2	\$ 11,000	\$ -	\$ -	\$ 19,064	\$ 14,153	\$ 20,152	\$ 53,368
TSF-H152	H152-1	\$ -	\$ -	\$ -	\$ 7,839	\$ 10,972	\$ 26,622	\$ 45,433
TSF-H152	H152-2	\$ -	\$ -	\$ -	\$ -	\$ -	\$ -	\$ -
TSF-H153	H153-1	\$ -	\$ -	\$ -	\$ 32,718	\$ 41,669	\$ 59,332	\$ 133,719
TSF-H153	H153-2	\$ -	\$ -	\$ -	\$ 30,233	\$ 15,111	\$ 21,516	\$ 66,859
TSF-H154	H154-1	\$ -	\$ -	\$ -	\$ -	\$ -	\$ -	\$ -
TSF-H155	H155-1	\$ -	\$ -	\$ -	\$ -	\$ -	\$ -	\$ -
TSF-H155	H155-2	\$ -	\$ -	\$ -	\$ -	\$ -	\$ -	\$ -
TSF-H156	H156-1	\$ -	\$ -	\$ -	\$ -	\$ -	\$ -	\$ -
TSF-H156	H156-2	\$ -	\$ -	\$ -	\$ -	\$ -	\$ 39,465	\$ 39,465
TSF-H157	H157-1	\$ -	\$ -	\$ -	\$ -	\$ -	\$ 11,000	\$ 11,000
TSF-H157	H157-2	\$ -	\$ -	\$ -	\$ -	\$ -	\$ -	\$ -
TSF-H157	H157-3	\$ -	\$ -	\$ -	\$ -	\$ -	\$ -	\$ -
TSF-H158	H158-1	\$ -	\$ -	\$ -	\$ 19,567	\$ 41,114	\$ 2,533,541	\$ 2,594,223
TSF-H158	H158-2	\$ -	\$ -	\$ -	\$ 120,938	\$ 115,492	\$ 36,813,696	\$ 37,050,126
TSF-H159	H159-1	\$ -	\$ -	\$ -	\$ 7,885	\$ 13,728	\$ 2,494,547	\$ 2,516,160
TSF-H159	H159-2	\$ -	\$ -	\$ -	\$ 181,542	\$ 104,802	\$ 22,049,125	\$ 22,335,469
TSF-H160	H160-1	\$ -	\$ -	\$ -	\$ 58,000	\$ 63,733	\$ 90,747	\$ 212,480
TSF-H160	H160-2	\$ -	\$ -	\$ -	\$ 25,929	\$ 18,294	\$ 26,048	\$ 70,271
TSF-H161	H161-1	\$ -	\$ -	\$ -	\$ 97,397	\$ 68,613	\$ 97,695	\$ 263,705
TSF-H161	H161-2	\$ -	\$ -	\$ -	\$ -	\$ -	\$ -	\$ -
TSF-H162	H162-1	\$ -	\$ -	\$ -	\$ -	\$ -	\$ -	\$ -
TSF-H162	H162-2	\$ -	\$ -	\$ -	\$ -	\$ -	\$ -	\$ -
TSF-H163	H163-1	\$ -	\$ -	\$ -	\$ -	\$ -	\$ -	\$ -
TSF-H164	H164-1	\$ -	\$ -	\$ -	\$ -	\$ 11,000	\$ 48,216	\$ 59,216
TSF-H164	H164-2	\$ -	\$ -	\$ -	\$ -	\$ -	\$ 52,220	\$ 52,220
TSF-H165	H165-1	\$ -	\$ -	\$ -	\$ -	\$ -	\$ -	\$ -
TSF-H165	H165-2	\$ -	\$ -	\$ -	\$ -	\$ -	\$ -	\$ -
TSF-H166	H166-1	\$ -	\$ -	\$ -	\$ 21,934	\$ 49,142	\$ 69,971	\$ 141,047
TSF-H166	H166-2	\$ -	\$ -	\$ -	\$ -	\$ -	\$ -	\$ -
TSF-H167	H167-1	\$ -	\$ -	\$ -	\$ 26,965	\$ 14,348	\$ 20,430	\$ 61,743
TSF-H168	H168-1	\$ -	\$ -	\$ -	\$ 34,104	\$ 20,924	\$ 29,793	\$ 84,821
TSF-H169	H169-1	\$ -	\$ -	\$ -	\$ -	\$ -	\$ 38,001	\$ 38,001
TSF-H170	H170-1	\$ -	\$ -	\$ -	\$ -	\$ -	\$ -	\$ -
TSF-H170	H170-2	\$ -	\$ -	\$ -	\$ -	\$ -	\$ -	\$ -
TSF-H171	H171-1	\$ -	\$ -	\$ -	\$ 39,469	\$ 53,068	\$ 75,561	\$ 168,098
TSF-H171	H171-2	\$ -	\$ -	\$ -	\$ -	\$ -	\$ 10,303	\$ 10,303
TSF-H172	H172-1	\$ -	\$ -	\$ -	\$ -	\$ -	\$ -	\$ -
TSF-H172	H172-2	\$ -	\$ -	\$ -	\$ 16,364	\$ 35,032	\$ 49,881	\$ 101,277
TSF-H173	H173-1	\$ -	\$ -	\$ -	\$ -	\$ 23,997	\$ 48,700	\$ 72,697
TSF-H173	H173-2	\$ -	\$ -	\$ -	\$ -	\$ -	\$ 21,043	\$ 21,043

SUBSTATION	CKT	Regulator Cost (\$)			Upgrade Costs By Year (\$)			Total Cost of Upgrades (\$)
		2016 Regulator Upgrade (\$)	2020 Regulator Upgrade (\$)	2030 Regulator Upgrade (\$)	2016 Total Cost of Upgrades (\$)	2020 Total Cost of Upgrades (\$)	2030 Total Cost of Upgrades (\$)	
Hawaiian Electric								
TSF-H174	H174-1	\$ -	\$ -	\$ -	\$ -	\$ -	\$ -	\$ -
TSF-H174	H174-2	\$ -	\$ -	\$ -	\$ -	\$ -	\$ 61,151	\$ 61,151
TSF-H175	H175-1	\$ -	\$ -	\$ -	\$ -	\$ -	\$ -	\$ -
TSF-H176	H176-1	\$ -	\$ -	\$ -	\$ -	\$ -	\$ -	\$ -
TSF-H176	H176-2	\$ -	\$ -	\$ -	\$ -	\$ -	\$ -	\$ -
TSF-H177	H177-1	\$ -	\$ -	\$ -	\$ -	\$ -	\$ -	\$ -
TSF-H178	H178-1	\$ -	\$ -	\$ -	\$ -	\$ -	\$ -	\$ -
TSF-H178	H178-2	\$ -	\$ -	\$ -	\$ 88,507	\$ 76,193	\$ 108,488	\$ 273,187
TSF-H179	H179-1	\$ -	\$ -	\$ -	\$ -	\$ -	\$ 11,000	\$ 11,000
TSF-H179	H179-2	\$ -	\$ -	\$ -	\$ -	\$ 17,433	\$ 49,223	\$ 66,657
TSF-H180	H180-1	\$ -	\$ -	\$ -	\$ 132,649	\$ 77,817	\$ 19,625,351	\$ 19,835,817
TSF-H180	H180-2	\$ -	\$ -	\$ -	\$ -	\$ 11,236	\$ 42,538	\$ 53,775
TSF-H181	H181-1	\$ -	\$ -	\$ -	\$ -	\$ -	\$ -	\$ -
TSF-H182	H182-1	\$ -	\$ -	\$ -	\$ -	\$ -	\$ -	\$ -
TSF-H183	H183-1	\$ -	\$ -	\$ -	\$ -	\$ 47,091	\$ 74,670	\$ 121,761
TSF-H183	H183-2	\$ -	\$ -	\$ -	\$ 42,049	\$ 24,969	\$ 35,552	\$ 102,570
TSF-H184	H184-1	\$ -	\$ -	\$ -	\$ 48,579	\$ 56,582	\$ 80,566	\$ 185,727
TSF-H184	H184-2	\$ -	\$ -	\$ -	\$ 43,925	\$ 26,535	\$ 37,782	\$ 108,242
TSF-H185	H185-1	\$ -	\$ -	\$ -	\$ -	\$ -	\$ 36,747	\$ 36,747
TSF-H185	H185-2	\$ -	\$ -	\$ -	\$ 79,633	\$ 50,134	\$ 71,385	\$ 201,152
TSF-H186	H186-1	\$ -	\$ -	\$ -	\$ -	\$ -	\$ 50,592	\$ 50,592
TSF-H186	H186-2	\$ -	\$ -	\$ -	\$ -	\$ -	\$ -	\$ -
TSF-H187	H187-1	\$ -	\$ -	\$ -	\$ -	\$ -	\$ -	\$ -
TSF-H187	H187-2	\$ -	\$ -	\$ -	\$ 36,452	\$ 61,750	\$ 87,924	\$ 186,126
TSF-H188	H188-1	\$ -	\$ -	\$ -	\$ 29,111	\$ 48,204	\$ 68,636	\$ 145,951
TSF-H188	H188-2	\$ -	\$ -	\$ -	\$ -	\$ -	\$ -	\$ -
TSF-H189	H189-1	\$ -	\$ -	\$ -	\$ -	\$ -	\$ 36,696	\$ 36,696
TSF-H190	H190-1	\$ -	\$ -	\$ -	\$ -	\$ -	\$ 11,000	\$ 11,000
TSF-H191	H191-1	\$ -	\$ -	\$ -	\$ -	\$ -	\$ 10,806	\$ 10,806
TSF-H192	H192-1	\$ -	\$ -	\$ -	\$ -	\$ -	\$ 17,135	\$ 17,135
TSF-H192	H192-2	\$ -	\$ -	\$ -	\$ -	\$ -	\$ 20,048	\$ 20,048
TSF-H193	H193-1	\$ -	\$ -	\$ -	\$ 54,345	\$ 28,148	\$ 2,515,078	\$ 2,597,571
TSF-H193	H193-2	\$ -	\$ -	\$ -	\$ 57,043	\$ 32,243	\$ 45,910	\$ 135,196
TSF-H194	H194-1	\$ -	\$ -	\$ -	\$ 16,148	\$ 2,642	\$ 3,762	\$ 22,553
TSF-H194	H194-2	\$ -	\$ -	\$ -	\$ 14,276	\$ 19,055	\$ 27,132	\$ 60,463
TSF-H195	H195-1	\$ -	\$ -	\$ -	\$ 37,118	\$ 17,228	\$ 2,499,531	\$ 2,553,877
TSF-H195	H195-2	\$ -	\$ -	\$ -	\$ 8,878	\$ 14,894	\$ 21,207	\$ 44,979
TSF-H196	H196-1	\$ -	\$ -	\$ -	\$ 28,688	\$ 16,230	\$ 2,498,110	\$ 2,543,028
TSF-H197	H197-1	\$ 11,000	\$ -	\$ -	\$ 32,070	\$ 11,785	\$ 16,781	\$ 60,637
Mauli Electric								
TSF-M1	M1-1	\$ -	\$ -	\$ -	\$ -	\$ 71,987	\$ 14,423	\$ 86,410
TSF-M1	M1-2	\$ -	\$ -	\$ -	\$ 3,117	\$ 68,176	\$ 1,242	\$ 72,535

SUBSTATION	CKT	LTC Substation Upgrade (\$)			Reconductor (\$/mile)			Substation Cost (\$)	
		2016 Substation LTC Costs (\$)	2020 Substation LTC Costs (\$)	2030 Substation LTC Costs (\$)	2016 Reconductor (\$)	2020 Reconductor (\$)	2030 Reconductor (\$)	2016 Substation Transformer Upgrade (\$)	2030 Substation Transformer Upgrade (\$)
Hawaiian Electric									
TSF-M2	M2-1	\$ -	\$ -	-	\$ -	\$ -	-	\$ -	\$ -
TSF-M2	M2-2	\$ -	\$ -	-	\$ -	\$ -	-	\$ -	\$ -
TSF-M2	M2-3	\$ -	\$ -	-	\$ -	\$ -	-	\$ -	\$ -
TSF-M3	M3-1	\$ 44,000	\$ -	-	\$ -	\$ -	-	\$ 66,000	\$ -
TSF-M4	M4-1	\$ -	\$ -	11,000	\$ -	\$ -	-	\$ -	\$ -
TSF-M4	M4-2	\$ -	\$ -	-	\$ -	\$ -	-	\$ -	\$ -
TSF-M4	M4-3	\$ 30,000	\$ -	-	\$ -	\$ -	-	\$ -	\$ -
TSF-M4	M4-4	\$ -	\$ -	-	\$ -	\$ -	-	\$ -	\$ -
TSF-M4	M4-5	\$ -	\$ -	30,000	\$ -	\$ -	-	\$ -	\$ -
TSF-M5	M5-1	\$ -	\$ -	-	\$ -	\$ -	-	\$ -	\$ -
TSF-M6	M6-1	\$ -	\$ -	-	\$ -	\$ -	-	\$ -	\$ -
TSF-M7	M7-1	\$ 11,000	\$ -	-	\$ -	\$ -	-	\$ -	\$ -
TSF-M7	M7-2	\$ -	\$ -	-	\$ -	\$ -	-	\$ -	\$ -
TSF-M7	M7-3	\$ -	\$ -	11,000	\$ -	\$ -	-	\$ -	\$ -
TSF-M7	M7-4	\$ -	\$ -	-	\$ -	\$ -	-	\$ -	\$ -
TSF-M7	M7-5	\$ -	\$ -	11,000	\$ -	\$ -	-	\$ -	\$ -
TSF-M7	M7-6	\$ -	\$ -	-	\$ -	\$ -	-	\$ -	\$ -
TSF-M8	M8-1	\$ -	\$ -	-	\$ -	\$ -	-	\$ -	\$ -
TSF-M9	M9-1	\$ -	\$ -	-	\$ -	\$ -	-	\$ -	\$ -
TSF-M10	M10-1	\$ -	\$ -	-	\$ -	\$ -	-	\$ -	\$ -
TSF-M10	M10-2	\$ -	\$ -	-	\$ -	\$ -	-	\$ -	\$ -
TSF-M10	M10-3	\$ -	\$ -	-	\$ -	\$ -	-	\$ -	\$ -
TSF-M10	M10-4	\$ -	\$ -	11,000	\$ -	\$ -	-	\$ -	\$ -
TSF-M10	M10-5	\$ 11,000	\$ -	-	\$ -	\$ -	-	\$ -	\$ -
TSF-M10	M10-6	\$ -	\$ -	-	\$ -	\$ -	-	\$ -	\$ -
TSF-M11	M11-1	\$ -	\$ -	-	\$ -	\$ -	-	\$ -	\$ -
TSF-M12	M12-1	\$ 11,000	\$ -	-	\$ -	\$ -	-	\$ -	\$ -
TSF-M12	M12-2	\$ -	\$ -	-	\$ -	\$ -	-	\$ -	\$ -
TSF-M13	M13-1	\$ 11,000	\$ -	-	\$ -	\$ -	-	\$ -	\$ -
TSF-M14	M14-1	\$ -	\$ -	-	\$ -	\$ -	-	\$ -	\$ -
TSF-M14	M14-2	\$ -	\$ -	-	\$ -	\$ -	-	\$ -	\$ -
TSF-M14	M14-3	\$ -	\$ -	-	\$ -	\$ -	-	\$ -	\$ -
TSF-M14	M14-4	\$ -	\$ -	-	\$ -	\$ -	-	\$ -	\$ -
TSF-M14	M14-5	\$ -	\$ -	11,000	\$ -	\$ -	-	\$ -	\$ -
TSF-M14	M14-6	\$ -	\$ -	-	\$ -	\$ -	-	\$ -	\$ -
TSF-M14	M14-7	\$ -	\$ -	-	\$ -	\$ -	-	\$ -	\$ -
TSF-M15	M15-1	\$ -	\$ -	11,000	\$ -	\$ -	-	\$ -	\$ -
TSF-M15	M15-2	\$ -	\$ -	-	\$ -	\$ -	-	\$ -	\$ -
TSF-M16	M16-1	\$ -	\$ -	-	\$ -	\$ -	-	\$ -	\$ -
TSF-M16	M16-2	\$ 11,000	\$ -	-	\$ -	\$ -	-	\$ -	\$ -
TSF-M16	M16-3	\$ -	\$ -	-	\$ -	\$ -	-	\$ -	\$ -
TSF-M17	M17-1	\$ 11,000	\$ -	-	\$ -	\$ -	-	\$ -	\$ -

SUBSTATION	CKT	Regulator Cost (\$)			Upgrade Costs By Year (\$)			Total Cost of Upgrades (\$)
		2016 Regulator Upgrade (\$)	2020 Regulator Upgrade (\$)	2030 Regulator Upgrade (\$)	2016 Total Cost of Upgrades (\$)	2020 Total Cost of Upgrades (\$)	2030 Total Cost of Upgrades (\$)	
Hawaiian Electric								
TSF-M2	M2-1	\$ -	\$ -	\$ -	\$ -	\$ -	\$ -	\$ -
TSF-M2	M2-2	\$ -	\$ -	\$ -	\$ -	\$ -	\$ -	\$ -
TSF-M2	M2-3	\$ -	\$ -	\$ -	\$ -	\$ -	\$ -	\$ -
TSF-M3	M3-1	\$ 11,000	\$ -	\$ -	\$ 121,312,567	\$ 66,145	\$ 83	\$ 187,541
TSF-M4	M4-1	\$ -	\$ -	\$ -	\$ -	\$ -	\$ 77,000	\$ 77,000
TSF-M4	M4-2	\$ -	\$ -	\$ -	\$ 66,000	\$ -	\$ -	\$ 66,000
TSF-M4	M4-3	\$ -	\$ -	\$ -	\$ 47,436	\$ 70,071	\$ 2,323	\$ 119,830
TSF-M4	M4-4	\$ -	\$ -	\$ -	\$ 5,681	\$ 68,793	\$ 1,594	\$ 76,069
TSF-M4	M4-5	\$ -	\$ -	\$ -	\$ 66,000	\$ -	\$ 31,647	\$ 97,647
TSF-M5	M5-1	\$ -	\$ -	\$ -	\$ -	\$ -	\$ -	\$ -
TSF-M6	M6-1	\$ -	\$ -	\$ -	\$ -	\$ -	\$ -	\$ -
TSF-M7	M7-1	\$ -	\$ -	\$ -	\$ 77,000	\$ -	\$ -	\$ 77,000
TSF-M7	M7-2	\$ -	\$ -	\$ -	\$ 66,000	\$ -	\$ -	\$ 66,000
TSF-M7	M7-3	\$ -	\$ -	\$ -	\$ 66,000	\$ -	\$ 11,000	\$ 77,000
TSF-M7	M7-4	\$ -	\$ -	\$ -	\$ -	\$ 85,543	\$ 5,916	\$ 91,459
TSF-M7	M7-5	\$ -	\$ -	\$ -	\$ -	\$ -	\$ 77,000	\$ 77,000
TSF-M7	M7-6	\$ -	\$ -	\$ -	\$ -	\$ 90,218	\$ 7,377	\$ 97,594
TSF-M8	M8-1	\$ -	\$ -	\$ -	\$ 3,430	\$ 67,846	\$ 1,054	\$ 72,329
TSF-M9	M9-1	\$ 11,000	\$ -	\$ -	\$ 77,000	\$ -	\$ -	\$ 77,000
TSF-M10	M10-1	\$ -	\$ -	\$ -	\$ -	\$ -	\$ 66,000	\$ 66,000
TSF-M10	M10-2	\$ -	\$ -	\$ -	\$ 66,000	\$ -	\$ -	\$ 66,000
TSF-M10	M10-3	\$ -	\$ -	\$ -	\$ -	\$ -	\$ -	\$ -
TSF-M10	M10-4	\$ -	\$ -	\$ -	\$ 66,000	\$ -	\$ 29,060	\$ 95,060
TSF-M10	M10-5	\$ -	\$ -	\$ -	\$ 45,519	\$ 78,585	\$ 7,183	\$ 131,287
TSF-M10	M10-6	\$ -	\$ -	\$ -	\$ 56,646	\$ 76,915	\$ 6,231	\$ 139,792
TSF-M11	M11-1	\$ -	\$ -	\$ -	\$ -	\$ 66,000	\$ -	\$ 66,000
TSF-M12	M12-1	\$ -	\$ -	\$ 11,000	\$ 11,000	\$ 83,855	\$ 16,816	\$ 111,671
TSF-M12	M12-2	\$ -	\$ -	\$ -	\$ 46,138	\$ 80,003	\$ 7,993	\$ 134,134
TSF-M13	M13-1	\$ -	\$ -	\$ -	\$ 12,337	\$ 66,141	\$ 81	\$ 78,559
TSF-M14	M14-1	\$ -	\$ -	\$ -	\$ -	\$ -	\$ -	\$ -
TSF-M14	M14-2	\$ -	\$ -	\$ -	\$ 14,519	\$ 71,865	\$ 3,348	\$ 89,731
TSF-M14	M14-3	\$ -	\$ -	\$ -	\$ -	\$ -	\$ 66,000	\$ 66,000
TSF-M14	M14-4	\$ -	\$ -	\$ -	\$ -	\$ -	\$ -	\$ -
TSF-M14	M14-5	\$ -	\$ -	\$ -	\$ 66,000	\$ -	\$ 11,000	\$ 77,000
TSF-M14	M14-6	\$ -	\$ -	\$ -	\$ -	\$ -	\$ -	\$ -
TSF-M14	M14-7	\$ -	\$ -	\$ -	\$ 66,000	\$ -	\$ -	\$ 66,000
TSF-M15	M15-1	\$ -	\$ -	\$ -	\$ 66,000	\$ -	\$ 25,981	\$ 91,981
TSF-M15	M15-2	\$ -	\$ -	\$ -	\$ -	\$ -	\$ 66,000	\$ 66,000
TSF-M16	M16-1	\$ -	\$ -	\$ -	\$ -	\$ -	\$ -	\$ -
TSF-M16	M16-2	\$ -	\$ -	\$ -	\$ 77,000	\$ -	\$ -	\$ 77,000
TSF-M16	M16-3	\$ -	\$ -	\$ -	\$ -	\$ -	\$ -	\$ -
TSF-M17	M17-1	\$ -	\$ -	\$ -	\$ 28,811	\$ 72,228	\$ 3,555	\$ 104,594

SUBSTATION	CKT	LTC Substation Upgrade (\$)			Reconductor (\$/mile)			Substation Cost (\$)	
		2016 Substation LTC Costs (\$)	2020 Substation LTC Costs (\$)	2030 Substation LTC Costs (\$)	2016 Reconductor (\$)	2020 Reconductor (\$)	2030 Reconductor (\$)	2016 Substation Transformer Upgrade (\$)	2030 Substation Transformer Upgrade (\$)
Hawaiian Electric									
TSF-M17	M17-2	\$ -	\$ -	\$ -	\$ -	\$ -	\$ -	\$ -	\$ -
TSF-M17	M17-3	\$ -	\$ -	\$ -	\$ -	\$ -	\$ -	\$ -	\$ -
TSF-M18	M18-1	\$ 11,000	\$ -	\$ -	\$ -	\$ -	\$ -	\$ -	\$ -
TSF-M19	M19-1	\$ -	\$ -	\$ -	\$ -	\$ -	\$ -	\$ -	\$ -
TSF-M20	M20-1	\$ -	\$ -	\$ -	\$ -	\$ -	\$ -	\$ -	\$ -
TSF-M20	M20-2	\$ -	\$ 11,000	\$ -	\$ -	\$ -	\$ -	\$ -	\$ -
TSF-M20	M20-3	\$ -	\$ -	\$ -	\$ -	\$ -	\$ -	\$ -	\$ -
TSF-M21	M21-1	\$ -	\$ -	\$ -	\$ -	\$ -	\$ -	\$ -	\$ -
TSF-M22	M22-1	\$ -	\$ -	\$ -	\$ -	\$ -	\$ -	\$ -	\$ -
TSF-M22	M22-2	\$ -	\$ -	\$ -	\$ -	\$ -	\$ -	\$ -	\$ -
TSF-M23	M23-1	\$ 30,000	\$ -	\$ -	\$ -	\$ -	\$ -	\$ -	\$ -
TSF-M24	M24-1	\$ 30,000	\$ -	\$ -	\$ -	\$ -	\$ -	\$ -	\$ -
TSF-M25	M25-1	\$ 11,000	\$ -	\$ -	\$ -	\$ -	\$ -	\$ -	\$ -
TSF-M25	M25-2	\$ -	\$ -	\$ -	\$ -	\$ -	\$ -	\$ -	\$ -
TSF-M25	M25-3	\$ 11,000	\$ -	\$ -	\$ -	\$ -	\$ -	\$ -	\$ -
TSF-M25	M25-4	\$ -	\$ -	\$ -	\$ -	\$ -	\$ -	\$ -	\$ -
TSF-M26	M26-1	\$ -	\$ -	\$ -	\$ -	\$ -	\$ -	\$ -	\$ -
TSF-M26	M26-2	\$ -	\$ -	\$ -	\$ -	\$ -	\$ -	\$ -	\$ -
TSF-M26	M26-3	\$ -	\$ 11,000	\$ -	\$ -	\$ -	\$ -	\$ -	\$ -
TSF-M26	M26-4	\$ -	\$ -	\$ -	\$ -	\$ -	\$ -	\$ -	\$ -
TSF-M27	M27-1	\$ 30,000	\$ -	\$ -	\$ -	\$ -	\$ -	\$ -	\$ 250,000
TSF-M28	M28-1	\$ 11,000	\$ -	\$ -	\$ -	\$ -	\$ -	\$ -	\$ -
TSF-M28	M28-2	\$ -	\$ -	\$ -	\$ -	\$ -	\$ -	\$ -	\$ -
TSF-M29	M29-1	\$ -	\$ -	\$ -	\$ -	\$ -	\$ -	\$ -	\$ -
TSF-M29	M29-2	\$ -	\$ -	\$ -	\$ -	\$ -	\$ -	\$ -	\$ -
TSF-M29	M29-3	\$ -	\$ 11,000	\$ -	\$ -	\$ -	\$ -	\$ -	\$ -
TSF-M29	M29-4	\$ -	\$ -	\$ -	\$ -	\$ -	\$ -	\$ -	\$ -
TSF-M29	M29-5	\$ 11,000	\$ -	\$ -	\$ -	\$ -	\$ -	\$ -	\$ -
TSF-M30	M30-1	\$ -	\$ -	\$ -	\$ -	\$ -	\$ -	\$ -	\$ -
TSF-M31	M31-1	\$ -	\$ -	\$ -	\$ -	\$ -	\$ -	\$ -	\$ -
TSF-M31	M31-2	\$ -	\$ -	\$ -	\$ -	\$ -	\$ -	\$ -	\$ -
TSF-M31	M31-3	\$ -	\$ -	\$ -	\$ -	\$ -	\$ -	\$ -	\$ -
TSF-M31	M31-4	\$ -	\$ -	\$ -	\$ -	\$ -	\$ -	\$ -	\$ -
TSF-M31	M31-5	\$ -	\$ -	\$ -	\$ -	\$ -	\$ -	\$ -	\$ -
TSF-M31	M31-6	\$ -	\$ -	\$ -	\$ -	\$ -	\$ -	\$ -	\$ -
TSF-M31	M31-7	\$ -	\$ -	\$ -	\$ -	\$ -	\$ -	\$ -	\$ -
TSF-M31	M31-8	\$ -	\$ -	\$ -	\$ -	\$ -	\$ -	\$ -	\$ -
TSF-M32	M32-1	\$ 11,000	\$ -	\$ -	\$ -	\$ -	\$ -	\$ -	\$ -
TSF-M32	M32-2	\$ -	\$ -	\$ -	\$ -	\$ -	\$ -	\$ -	\$ -
TSF-M32	M32-3	\$ -	\$ -	\$ -	\$ -	\$ -	\$ -	\$ -	\$ -
TSF-M32	M32-4	\$ 11,000	\$ -	\$ -	\$ -	\$ -	\$ -	\$ -	\$ -
TSF-M32	M32-5	\$ 11,000	\$ -	\$ -	\$ -	\$ -	\$ -	\$ -	\$ -

SUBSTATION	CKT	Regulator Cost (\$)		Upgrade Costs By Year (\$)			Total Cost of Upgrades (\$)
		2016 Regulator Upgrade (\$)	2030 Regulator Upgrade (\$)	2016 Total Cost of Upgrades (\$)	2020 Total Cost of Upgrades (\$)	2030 Total Cost of Upgrades (\$)	
Hawaiian Electric							
TSF-M17	M17-2	\$ -	\$ -	\$ -	\$ 72,771	\$ 2,229	\$ 75,000
TSF-M17	M17-3	\$ -	\$ 11,000	\$ 15,288	\$ 86,102	\$ 5,195	\$ 106,586
TSF-M18	M18-1	\$ -	\$ -	\$ 11,000	\$ -	\$ -	\$ 11,000
TSF-M19	M19-1	\$ -	\$ -	\$ -	\$ -	\$ -	\$ -
TSF-M20	M20-1	\$ -	\$ -	\$ -	\$ -	\$ -	\$ -
TSF-M20	M20-2	\$ -	\$ -	\$ 66,000	\$ 11,000	\$ -	\$ 77,000
TSF-M20	M20-3	\$ -	\$ -	\$ -	\$ -	\$ -	\$ -
TSF-M21	M21-1	\$ -	\$ -	\$ -	\$ -	\$ -	\$ -
TSF-M22	M22-1	\$ -	\$ -	\$ -	\$ -	\$ -	\$ -
TSF-M22	M22-2	\$ -	\$ -	\$ 7,384	\$ 67,860	\$ 1,062	\$ 76,306
TSF-M23	M23-1	\$ 11,000	\$ -	\$ 107,000	\$ -	\$ -	\$ 107,000
TSF-M24	M24-1	\$ -	\$ -	\$ 55,190	\$ 70,840	\$ 2,763	\$ 128,792
TSF-M25	M25-1	\$ -	\$ -	\$ 59,344	\$ 79,921	\$ 7,946	\$ 147,211
TSF-M25	M25-2	\$ -	\$ -	\$ 66,000	\$ -	\$ -	\$ 66,000
TSF-M25	M25-3	\$ -	\$ -	\$ 52,917	\$ 80,434	\$ 8,239	\$ 141,591
TSF-M25	M25-4	\$ -	\$ -	\$ 66,000	\$ -	\$ -	\$ 66,000
TSF-M26	M26-1	\$ -	\$ -	\$ -	\$ -	\$ 66,000	\$ 66,000
TSF-M26	M26-2	\$ -	\$ -	\$ -	\$ -	\$ -	\$ -
TSF-M26	M26-3	\$ -	\$ -	\$ 66,000	\$ 11,000	\$ -	\$ 77,000
TSF-M26	M26-4	\$ -	\$ -	\$ 66,000	\$ -	\$ -	\$ 66,000
TSF-M27	M27-1	\$ 11,000	\$ -	\$ 53,529	\$ 68,771	\$ 251,581	\$ 373,881
TSF-M28	M28-1	\$ -	\$ -	\$ 77,000	\$ -	\$ -	\$ 77,000
TSF-M28	M28-2	\$ -	\$ -	\$ 75,134	\$ 78,798	\$ 7,305	\$ 161,237
TSF-M29	M29-1	\$ -	\$ -	\$ 66,000	\$ -	\$ -	\$ 66,000
TSF-M29	M29-2	\$ -	\$ -	\$ -	\$ -	\$ 66,000	\$ 66,000
TSF-M29	M29-3	\$ -	\$ -	\$ 52,371	\$ 89,100	\$ 6,907	\$ 148,378
TSF-M29	M29-4	\$ -	\$ -	\$ -	\$ -	\$ -	\$ -
TSF-M29	M29-5	\$ -	\$ -	\$ 112,371	\$ 79,888	\$ 7,927	\$ 200,187
TSF-M30	M30-1	\$ -	\$ -	\$ -	\$ -	\$ -	\$ -
TSF-M31	M31-1	\$ -	\$ -	\$ -	\$ 66,000	\$ -	\$ 66,000
TSF-M31	M31-2	\$ -	\$ -	\$ -	\$ -	\$ 66,000	\$ 66,000
TSF-M31	M31-3	\$ -	\$ -	\$ -	\$ -	\$ -	\$ -
TSF-M31	M31-4	\$ -	\$ -	\$ -	\$ -	\$ -	\$ -
TSF-M31	M31-5	\$ -	\$ -	\$ -	\$ -	\$ -	\$ -
TSF-M31	M31-6	\$ -	\$ -	\$ -	\$ -	\$ -	\$ -
TSF-M31	M31-7	\$ -	\$ -	\$ 23,499	\$ 72,055	\$ 3,456	\$ 99,010
TSF-M31	M31-8	\$ -	\$ -	\$ -	\$ -	\$ -	\$ -
TSF-M32	M32-1	\$ -	\$ -	\$ 11,000	\$ 71,395	\$ 2,780	\$ 85,176
TSF-M32	M32-2	\$ -	\$ -	\$ -	\$ -	\$ -	\$ -
TSF-M32	M32-3	\$ -	\$ -	\$ 66,000	\$ -	\$ -	\$ 66,000
TSF-M32	M32-4	\$ -	\$ -	\$ 77,000	\$ -	\$ -	\$ 77,000
TSF-M32	M32-5	\$ -	\$ -	\$ 11,000	\$ 70,390	\$ 1,363	\$ 82,752

SUBSTATION	CKT	Grounding Transformer Cost (\$)		Distribution Transformer Cost (\$)		Pole and Secondary Cost (\$)	
		2016 Grounding Xfmr Addition (\$)	2030 Grounding Xfmr Addition (\$)	2016 Distribution Xfmr Upgrade (\$)	2030 Distribution Xfmr Upgrade (\$)	2016 Distribution Xfmr Upgrade (\$)	2030 Distribution Xfmr Upgrade (\$)
Hawaiian Electric							
TSF-M33	M33-1	\$ -	\$ -	\$ -	\$ -	\$ -	\$ -
TSF-M33	M33-2	\$ -	\$ -	\$ -	\$ -	\$ -	\$ -
TSF-M34	M34-1	\$ 66,000	\$ -	\$ -	\$ -	\$ -	\$ -
TSF-M35	M35-1	\$ -	\$ -	\$ -	\$ -	\$ -	\$ -
TSF-M35	M35-2	\$ -	\$ 66,000	\$ -	\$ -	\$ -	\$ -
TSF-M35	M35-3	\$ -	\$ 66,000	\$ 7,026.50	\$ 4,704	\$ 1,580.96	\$ 1,058
TSF-M35	M35-4	\$ -	\$ 66,000	\$ 21,335.39	\$ 4,223	\$ 4,800.46	\$ 950
TSF-M35	M35-5	\$ -	\$ 66,000	\$ 18,821.84	\$ 3,095	\$ 4,234.91	\$ 696
TSF-M36	M36-1	\$ -	\$ -	\$ -	\$ -	\$ -	\$ -
TSF-M36	M36-2	\$ -	\$ -	\$ -	\$ -	\$ -	\$ -
TSF-M36	M36-3	\$ -	\$ -	\$ -	\$ -	\$ -	\$ -
TSF-M37	M37-1	\$ -	\$ -	\$ -	\$ -	\$ -	\$ -
TSF-M37	M37-2	\$ -	\$ -	\$ -	\$ -	\$ -	\$ -
TSF-M37	M37-3	\$ -	\$ -	\$ -	\$ -	\$ -	\$ -
Hawaii Electric Light							
TSF-L1	L1-1	\$ -	\$ -	\$ -	\$ -	\$ -	\$ -
TSF-L1	L1-2	\$ -	\$ -	\$ -	\$ -	\$ -	\$ -
TSF-L2	L2-1	\$ -	\$ -	\$ -	\$ -	\$ -	\$ -
TSF-L2	L2-2	\$ -	\$ -	\$ -	\$ -	\$ -	\$ -
TSF-L3	L3-1	\$ 66,000	\$ -	\$ -	\$ -	\$ -	\$ -
TSF-L3	L3-2	\$ -	\$ -	\$ -	\$ -	\$ -	\$ -
TSF-L4	L4-1	\$ -	\$ -	\$ 1,117.94	\$ 1,545	\$ 268.31	\$ 371
TSF-L5	L5-1	\$ -	\$ -	\$ -	\$ -	\$ -	\$ -
TSF-L6	L6-1	\$ -	\$ -	\$ -	\$ -	\$ -	\$ -
TSF-L7	L7-1	\$ -	\$ -	\$ -	\$ -	\$ -	\$ -
TSF-L8	L8-1	\$ -	\$ -	\$ 3,081	\$ -	\$ -	\$ 739
TSF-L8	L8-2	\$ -	\$ -	\$ -	\$ -	\$ -	\$ -
TSF-L9	L9-1	\$ -	\$ -	\$ -	\$ -	\$ -	\$ -
TSF-L9	L9-2	\$ -	\$ -	\$ -	\$ -	\$ -	\$ -
TSF-L10	L10-1	\$ -	\$ -	\$ -	\$ -	\$ -	\$ -
TSF-L11	L11-1	\$ -	\$ -	\$ 14,494.58	\$ 11,535	\$ 3,478.70	\$ 2,768
TSF-L11	L11-2	\$ -	\$ -	\$ -	\$ -	\$ -	\$ -
TSF-L12	L12-1	\$ -	\$ -	\$ 16,519	\$ -	\$ -	\$ 3,965
TSF-L12	L12-2	\$ -	\$ -	\$ 5,909	\$ -	\$ -	\$ 1,418
TSF-L13	L13-1	\$ -	\$ -	\$ 30,292.57	\$ 25,400	\$ 7,270.22	\$ 6,096
TSF-L14	L14-1	\$ -	\$ -	\$ 32,002.77	\$ 14,423	\$ 7,680.66	\$ 3,461
TSF-L14	L14-2	\$ -	\$ -	\$ -	\$ -	\$ -	\$ -
TSF-L14	L14-3	\$ -	\$ -	\$ -	\$ -	\$ -	\$ -
TSF-L14	L14-4	\$ -	\$ 66,000	\$ 22,996.42	\$ 14,176	\$ 5,519.14	\$ 3,402
TSF-L15	L15-1	\$ -	\$ -	\$ -	\$ -	\$ -	\$ -
TSF-L15	L15-2	\$ -	\$ -	\$ -	\$ -	\$ -	\$ -
TSF-L15	L15-3	\$ -	\$ 132,000	\$ -	\$ -	\$ -	\$ -

SUBSTATION	CKT	Regulator Cost (\$)			Upgrade Costs By Year (\$)			Total Cost of Upgrades (\$)	
		2016 Regulator Upgrade (\$)	2020 Regulator Upgrade (\$)	2030 Regulator Upgrade (\$)	2016 Total Cost of Upgrades (\$)	2020 Total Cost of Upgrades (\$)	2030 Total Cost of Upgrades (\$)		
Hawaiian Electric									
TSF-M33	M33-1	\$	-	\$	-	\$	66,000	\$	66,000
TSF-M33	M33-2	\$	-	\$	-	\$	66,000	\$	66,000
TSF-M34	M34-1	\$	-	\$	-	\$	66,000	\$	40,000
TSF-M35	M35-1	\$	-	\$	-	\$	-	\$	-
TSF-M35	M35-2	\$	-	\$	-	\$	66,000	\$	66,000
TSF-M35	M35-3	\$	-	\$	-	\$	8,607	\$	71,763
TSF-M35	M35-4	\$	-	\$	-	\$	26,136	\$	71,173
TSF-M35	M35-5	\$	-	\$	-	\$	23,057	\$	69,791
TSF-M36	M36-1	\$	-	\$	-	\$	-	\$	-
TSF-M36	M36-2	\$	-	\$	-	\$	-	\$	-
TSF-M36	M36-3	\$	-	\$	-	\$	-	\$	-
TSF-M37	M37-1	\$	-	\$	-	\$	-	\$	-
TSF-M37	M37-2	\$	-	\$	-	\$	-	\$	-
TSF-M37	M37-3	\$	-	\$	-	\$	-	\$	-
Hawaii Electric Light									
TSF-L1	L1-1	\$	-	\$	-	\$	-	\$	-
TSF-L1	L1-2	\$	-	\$	-	\$	-	\$	-
TSF-L2	L2-1	\$	-	\$	-	\$	-	\$	-
TSF-L2	L2-2	\$	-	\$	-	\$	-	\$	-
TSF-L3	L3-1	\$	-	\$	-	\$	66,000	\$	66,000
TSF-L3	L3-2	\$	-	\$	-	\$	-	\$	-
TSF-L4	L4-1	\$	-	\$	11,000	\$	1,386	\$	23,916
TSF-L4	L4-2	\$	-	\$	-	\$	-	\$	120
TSF-L5	L5-1	\$	-	\$	-	\$	-	\$	-
TSF-L6	L6-1	\$	-	\$	-	\$	-	\$	-
TSF-L7	L7-1	\$	-	\$	-	\$	-	\$	-
TSF-L8	L8-1	\$	-	\$	-	\$	3,820	\$	11,228
TSF-L8	L8-2	\$	-	\$	-	\$	-	\$	-
TSF-L9	L9-1	\$	-	\$	-	\$	-	\$	-
TSF-L9	L9-2	\$	-	\$	-	\$	-	\$	-
TSF-L10	L10-1	\$	-	\$	-	\$	-	\$	-
TSF-L11	L11-1	\$	-	\$	-	\$	28,973	\$	14,303
TSF-L11	L11-2	\$	-	\$	-	\$	-	\$	893
TSF-L12	L12-1	\$	-	\$	-	\$	20,483	\$	12,015
TSF-L12	L12-2	\$	-	\$	-	\$	-	\$	484
TSF-L13	L13-1	\$	-	\$	-	\$	48,563	\$	31,496
TSF-L14	L14-1	\$	-	\$	-	\$	39,683	\$	17,884
TSF-L14	L14-2	\$	-	\$	-	\$	-	\$	-
TSF-L14	L14-3	\$	-	\$	-	\$	11,000	\$	-
TSF-L14	L14-4	\$	-	\$	-	\$	28,516	\$	83,578
TSF-L15	L15-1	\$	-	\$	-	\$	-	\$	1,097
TSF-L15	L15-2	\$	-	\$	-	\$	-	\$	-
TSF-L15	L15-3	\$	-	\$	-	\$	-	\$	66,000
TSF-L15	L15-3	\$	-	\$	-	\$	132,000	\$	132,000

SUBSTATION	CKT	Grounding Transformer Cost (\$)		Distribution Transformer Cost (\$)		Pole and Secondary Cost (\$)			
		2016 Grounding Xfrmr Addition (\$)	2030 Grounding Xfrmr Addition (\$)	2016 Distribution Xfrmr Upgrade (\$)	2030 Distribution Xfrmr Upgrade (\$)	2016 Distribution Xfrmr Upgrade (\$)	2020 Distribution Xfrmr Upgrade (\$)	2030 Distribution Xfrmr Upgrade (\$)	
Hawaiian Electric									
	L16-1	\$ -	\$ 66,000	\$ -	\$ 11,218	\$ 700	\$ 2,858.67	\$ 2,692	\$ 168
	L16-2	\$ -	\$ -	\$ -	\$ 2,384	\$ 149	\$ 2,142.05	\$ 572	\$ 36
	L16-3	\$ -	\$ 66,000	\$ -	\$ 8,956	\$ 559	\$ 5,423.26	\$ 2,149	\$ 134
	L16-4	\$ -	\$ -	\$ -	\$ 1,582.77	\$ 56	\$ 379.87	\$ 217	\$ 14
	L17-1	\$ -	\$ -	\$ -	\$ -	\$ -	\$ -	\$ -	\$ -
	L17-2	\$ -	\$ -	\$ -	\$ 3,584	\$ 284	\$ -	\$ 860	\$ 68
	L18-1	\$ -	\$ -	\$ -	\$ -	\$ -	\$ -	\$ -	\$ -
	L18-2	\$ -	\$ -	\$ -	\$ -	\$ -	\$ -	\$ -	\$ -
	L18-3	\$ -	\$ -	\$ -	\$ -	\$ -	\$ -	\$ -	\$ -
	L18-4	\$ -	\$ -	\$ -	\$ -	\$ -	\$ -	\$ -	\$ -
	L18-5	\$ -	\$ -	\$ -	\$ 5,798	\$ 362	\$ 1,241.52	\$ 1,391	\$ 87
	L19-1	\$ -	\$ -	\$ -	\$ -	\$ -	\$ -	\$ -	\$ -
	L19-2	\$ -	\$ -	\$ -	\$ -	\$ -	\$ -	\$ -	\$ -
	L20-1	\$ -	\$ -	\$ -	\$ -	\$ -	\$ -	\$ -	\$ -
	L20-2	\$ -	\$ 66,000	\$ -	\$ -	\$ -	\$ -	\$ -	\$ -
	L20-3	\$ -	\$ -	\$ -	\$ -	\$ -	\$ -	\$ -	\$ -
	L21-1	\$ -	\$ -	\$ -	\$ 1,614	\$ 87	\$ -	\$ 387	\$ 21
	L21-2	\$ -	\$ -	\$ -	\$ -	\$ -	\$ -	\$ -	\$ -
	L21-3	\$ -	\$ -	\$ -	\$ 6,350	\$ 396	\$ 2,439.84	\$ 1,524	\$ 95
	L22-1	\$ -	\$ -	\$ -	\$ 67,714.72	\$ -	\$ 16,251.53	\$ -	\$ -
	L22-2	\$ -	\$ -	\$ -	\$ -	\$ -	\$ -	\$ -	\$ -
	L23-1	\$ -	\$ -	\$ -	\$ 5,598	\$ 409	\$ -	\$ 1,343	\$ 98
	L24-1	\$ -	\$ -	\$ -	\$ 14,670.35	\$ 829	\$ 3,520.88	\$ 3,188	\$ 199
	L24-2	\$ -	\$ -	\$ -	\$ 12,787.10	\$ 423	\$ 3,068.90	\$ 1,626	\$ 101
	L25-1	\$ -	\$ -	\$ -	\$ 896	\$ 56	\$ 199.37	\$ 215	\$ 13
	L25-2	\$ -	\$ 66,000	\$ -	\$ 5,501	\$ 343	\$ 3,588.99	\$ 1,320	\$ 82
	L26-1	\$ -	\$ -	\$ -	\$ 44,772.36	\$ 1,170	\$ 10,745.37	\$ 4,498	\$ 281
	L26-2	\$ -	\$ -	\$ -	\$ 48,650.90	\$ 1,085	\$ 11,676.22	\$ 4,172	\$ 260
	L27-1	\$ -	\$ -	\$ -	\$ -	\$ -	\$ -	\$ -	\$ -
	L27-2	\$ -	\$ -	\$ -	\$ 485	\$ 54	\$ -	\$ 116	\$ 13
	L27-3	\$ -	\$ -	\$ -	\$ 17,289.72	\$ 416	\$ 4,149.53	\$ 1,598	\$ 100
	L28-1	\$ -	\$ -	\$ -	\$ 2,083.06	\$ 231	\$ 499.93	\$ 887	\$ 55
	L28-2	\$ -	\$ -	\$ -	\$ -	\$ -	\$ -	\$ -	\$ -
	L29-1	\$ -	\$ -	\$ -	\$ 10,971.41	\$ 326	\$ 2,633.14	\$ 1,254	\$ 78
	L30-1	\$ -	\$ -	\$ -	\$ -	\$ -	\$ -	\$ -	\$ -
	L30-2	\$ -	\$ -	\$ -	\$ -	\$ -	\$ -	\$ -	\$ -
	L31-1	\$ -	\$ -	\$ -	\$ 3,923.65	\$ 313	\$ 941.68	\$ 1,202	\$ 75
	L31-2	\$ -	\$ -	\$ -	\$ -	\$ -	\$ -	\$ -	\$ -
	L32-1	\$ -	\$ -	\$ -	\$ 40,024.32	\$ 1,538	\$ 9,605.84	\$ 5,914	\$ 369
	L32-2	\$ -	\$ 66,000	\$ -	\$ 15,128.16	\$ 948	\$ 3,630.76	\$ 3,644	\$ 227
	L32-3	\$ -	\$ -	\$ -	\$ 1,137	\$ 55	\$ -	\$ 273	\$ 13
	L33-1	\$ -	\$ 66,000	\$ -	\$ -	\$ -	\$ -	\$ -	\$ -

SUBSTATION	CKT	Regulator Cost (\$)			Upgrade Costs By Year (\$)			Total Cost of Upgrades (\$)
		2016 Regulator Upgrade (\$)	2020 Regulator Upgrade (\$)	2030 Regulator Upgrade (\$)	2016 Total Cost of Upgrades (\$)	2020 Total Cost of Upgrades (\$)	2030 Total Cost of Upgrades (\$)	
Hawaiian Electric								
TSF-L16	L16-1	\$ -	\$ -	\$ -	\$ 25,770	\$ 79,910	\$ 868	\$ 106,548
TSF-L16	L16-2	\$ -	\$ -	\$ -	\$ 11,067	\$ 2,956	\$ 184	\$ 14,208
TSF-L16	L16-3	\$ -	\$ -	\$ -	\$ 39,020	\$ 77,105	\$ 693	\$ 116,818
TSF-L16	L16-4	\$ -	\$ -	\$ -	\$ 1,963	\$ 1,120	\$ 70	\$ 3,152
TSF-L17	L17-1	\$ -	\$ -	\$ -	\$ -	\$ -	\$ -	\$ -
TSF-L17	L17-2	\$ -	\$ -	\$ -	\$ -	\$ 4,444	\$ 352	\$ 4,796
TSF-L18	L18-1	\$ -	\$ -	\$ -	\$ -	\$ -	\$ -	\$ -
TSF-L18	L18-2	\$ -	\$ -	\$ -	\$ -	\$ -	\$ -	\$ -
TSF-L18	L18-3	\$ -	\$ -	\$ -	\$ -	\$ -	\$ -	\$ -
TSF-L18	L18-4	\$ -	\$ -	\$ -	\$ -	\$ -	\$ -	\$ -
TSF-L18	L18-5	\$ -	\$ -	\$ -	\$ 6,415	\$ 7,189	\$ 449	\$ 14,053
TSF-L19	L19-1	\$ -	\$ -	\$ -	\$ -	\$ -	\$ -	\$ -
TSF-L19	L19-2	\$ -	\$ -	\$ -	\$ -	\$ -	\$ -	\$ -
TSF-L20	L20-1	\$ -	\$ -	\$ -	\$ -	\$ -	\$ -	\$ -
TSF-L20	L20-2	\$ -	\$ -	\$ -	\$ -	\$ -	\$ 66,000	\$ 66,000
TSF-L20	L20-3	\$ -	\$ -	\$ -	\$ -	\$ -	\$ -	\$ -
TSF-L21	L21-1	\$ -	\$ -	\$ -	\$ -	\$ 13,002	\$ 107	\$ 13,109
TSF-L21	L21-2	\$ -	\$ -	\$ -	\$ -	\$ -	\$ -	\$ -
TSF-L21	L21-3	\$ -	\$ -	\$ -	\$ 12,606	\$ 7,874	\$ 491	\$ 20,971
TSF-L22	L22-1	\$ -	\$ -	\$ -	\$ 2,569,966	\$ -	\$ -	\$ 2,569,966
TSF-L22	L22-2	\$ -	\$ -	\$ -	\$ -	\$ -	\$ -	\$ -
TSF-L23	L23-1	\$ -	\$ -	\$ -	\$ -	\$ 6,941	\$ 22,508	\$ 29,449
TSF-L24	L24-1	\$ -	\$ -	\$ -	\$ 18,191	\$ 27,471	\$ 1,028	\$ 46,690
TSF-L24	L24-2	\$ -	\$ -	\$ -	\$ 26,856	\$ 8,401	\$ 524	\$ 35,782
TSF-L25	L25-1	\$ 11,000	\$ -	\$ -	\$ 23,030	\$ 1,111	\$ 69	\$ 24,210
TSF-L25	L25-2	\$ 11,000	\$ -	\$ -	\$ 29,543	\$ 72,822	\$ 426	\$ 102,790
TSF-L26	L26-1	\$ -	\$ -	\$ -	\$ 66,518	\$ 23,238	\$ 1,450	\$ 91,206
TSF-L26	L26-2	\$ -	\$ -	\$ -	\$ 60,327	\$ 21,557	\$ 1,345	\$ 83,229
TSF-L27	L27-1	\$ -	\$ -	\$ -	\$ 11,000	\$ -	\$ -	\$ 11,000
TSF-L27	L27-2	\$ -	\$ -	\$ -	\$ -	\$ 602	\$ 67	\$ 668
TSF-L27	L27-3	\$ -	\$ -	\$ -	\$ 21,439	\$ 8,258	\$ 515	\$ 30,213
TSF-L28	L28-1	\$ -	\$ -	\$ -	\$ 2,583	\$ 4,584	\$ 286	\$ 7,454
TSF-L28	L28-2	\$ -	\$ -	\$ -	\$ -	\$ -	\$ -	\$ -
TSF-L29	L29-1	\$ -	\$ -	\$ -	\$ 24,605	\$ 6,477	\$ 404	\$ 31,486
TSF-L30	L30-1	\$ 11,000	\$ -	\$ -	\$ 22,000	\$ -	\$ -	\$ 22,000
TSF-L30	L30-2	\$ -	\$ -	\$ -	\$ -	\$ -	\$ -	\$ -
TSF-L31	L31-1	\$ -	\$ -	\$ -	\$ 4,865	\$ 6,210	\$ 388	\$ 11,463
TSF-L31	L31-2	\$ -	\$ -	\$ -	\$ -	\$ -	\$ -	\$ -
TSF-L32	L32-1	\$ -	\$ -	\$ -	\$ 60,630	\$ 30,554	\$ 1,907	\$ 93,091
TSF-L32	L32-2	\$ -	\$ -	\$ -	\$ 29,759	\$ 84,829	\$ 1,175	\$ 115,763
TSF-L32	L32-3	\$ -	\$ -	\$ -	\$ -	\$ 1,410	\$ 69	\$ 1,479
TSF-L33	L33-1	\$ -	\$ -	\$ -	\$ -	\$ 66,000	\$ -	\$ 66,000

SUBSTATION	CKT	Regulator Cost (\$)		Upgrade Costs By Year (\$)			Total Cost of Upgrades (\$)
		2016 Regulator Upgrade (\$)	2020 Regulator Upgrade (\$)	2016 Total Cost of Upgrades (\$)	2020 Total Cost of Upgrades (\$)	2030 Total Cost of Upgrades (\$)	
Hawaiian Electric							
TSF-L33	L33-2	\$ -	\$ -	\$ 24,392	\$ 4,769	\$ 298	\$ 29,459
TSF-L33	L33-3	\$ -	\$ -	\$ 30,723	\$ 17,034	\$ 1,063	\$ 48,820
TSF-L34	L34-1	\$ -	\$ 11,000	\$ 2,299	\$ 26,393	\$ 274	\$ 28,967
TSF-L35	L35-1	\$ -	\$ -	\$ 66,000	\$ 15,561	\$ 12,144	\$ 93,705
TSF-L35	L35-2	\$ -	\$ -	\$ 5,434	\$ 1,856	\$ 116	\$ 7,406
TSF-L36	L36-1	\$ 11,000	\$ -	\$ 13,138	\$ 11,796	\$ 50	\$ 24,983
TSF-L36	L36-2	\$ -	\$ -	\$ -	\$ -	\$ -	\$ -
TSF-L37	L37-1	\$ -	\$ -	\$ 17,149	\$ 2,278	\$ 142	\$ 19,568
TSF-L37	L37-2	\$ -	\$ -	\$ 2,964	\$ 2,550	\$ 159	\$ 5,673
TSF-L38	L38-1	\$ -	\$ -	\$ -	\$ -	\$ -	\$ -
TSF-L38	L38-2	\$ -	\$ -	\$ -	\$ -	\$ -	\$ -
TSF-L39	L39-1	\$ -	\$ -	\$ -	\$ -	\$ -	\$ -
TSF-L39	L39-2	\$ -	\$ -	\$ 8,406	\$ 2,865	\$ 179	\$ 11,450
TSF-L40	L40-1	\$ -	\$ -	\$ -	\$ -	\$ -	\$ -
TSF-L41	L41-1	\$ -	\$ -	\$ 18,378	\$ 2,513	\$ 157	\$ 21,047
TSF-L42	L42-1	\$ -	\$ -	\$ -	\$ -	\$ -	\$ -
TSF-L42	L42-2	\$ -	\$ -	\$ -	\$ -	\$ -	\$ -
TSF-L43	L43-1	\$ -	\$ -	\$ 18,310	\$ 12,615	\$ 787	\$ 31,713
TSF-L43	L43-2	\$ -	\$ -	\$ -	\$ -	\$ -	\$ -
TSF-L44	L44-1	\$ -	\$ -	\$ -	\$ -	\$ -	\$ -
TSF-L45	L45-1	\$ -	\$ -	\$ -	\$ -	\$ -	\$ -
TSF-L45	L45-2	\$ -	\$ -	\$ -	\$ 1,869	\$ 93	\$ 1,962
TSF-L46	L46-1	\$ -	\$ -	\$ 19,844	\$ 70,498	\$ 281	\$ 90,622
TSF-L46	L46-2	\$ -	\$ -	\$ 16,451	\$ 15,477	\$ 966	\$ 32,894
TSF-L47	L47-1	\$ -	\$ -	\$ 240,666	\$ 116,221	\$ 3,134	\$ 360,021
TSF-L47	L47-2	\$ -	\$ 11,000	\$ 66,000	\$ -	\$ 11,000	\$ 77,000
TSF-L48	L48-1	\$ -	\$ -	\$ -	\$ 658	\$ 76	\$ 734
TSF-L49	L49-1	\$ -	\$ -	\$ -	\$ -	\$ -	\$ -
TSF-L49	L49-2	\$ -	\$ -	\$ -	\$ -	\$ -	\$ -
TSF-L49	L49-3	\$ -	\$ -	\$ -	\$ -	\$ -	\$ -
TSF-L49	L49-4	\$ -	\$ -	\$ -	\$ -	\$ -	\$ -
TSF-L50	L50-1	\$ 11,000	\$ -	\$ 94,836	\$ 17,653	\$ 1,102	\$ 113,591
TSF-L50	L50-2	\$ -	\$ -	\$ -	\$ -	\$ -	\$ -
TSF-L51	L51-1	\$ -	\$ 11,000	\$ -	\$ -	\$ 11,000	\$ 11,000
TSF-L51	L51-2	\$ -	\$ -	\$ -	\$ -	\$ -	\$ -
TSF-L51	L51-3	\$ -	\$ -	\$ -	\$ -	\$ -	\$ -
TSF-L52	L52-1	\$ -	\$ -	\$ -	\$ -	\$ -	\$ -
TSF-L53	L53-1	\$ -	\$ -	\$ -	\$ 11,000	\$ -	\$ 11,000
TSF-L53	L53-2	\$ -	\$ -	\$ 3,215	\$ 1,647	\$ 103	\$ 4,964
TSF-L54	L54-1	\$ -	\$ -	\$ -	\$ -	\$ -	\$ -
TSF-L55	L55-1	\$ -	\$ -	\$ 3,557	\$ 13,378	\$ 148	\$ 17,084
TSF-L55	L55-2	\$ -	\$ -	\$ -	\$ 66,000	\$ -	\$ 66,000

ATTACHMENT G-Projects
40 of 42

SUBSTATION	CKT	LTC Substation Upgrade (\$)		Reconductor (\$/mile)		Substation Cost (\$)	
		2016 Substation LTC Costs (\$)	2030 Substation LTC Costs (\$)	2016 Reconductor (\$)	2030 Reconductor (\$)	2016 Substation Transformer Upgrade (\$)	2030 Substation Transformer Upgrade (\$)
Hawaiian Electric							
TSF-L56	L56-1	\$ -	\$ -	\$ -	\$ -	\$ -	\$ -
TSF-L57	L57-1	\$ 11,000	\$ -	\$ -	\$ -	\$ -	\$ -
TSF-L57	L57-2	\$ -	\$ -	\$ -	\$ -	\$ -	\$ -
TSF-L58	L58-1	\$ 11,000	\$ -	\$ -	\$ -	\$ -	\$ -
TSF-L59	L59-1	\$ 11,000	\$ -	\$ -	\$ -	\$ -	\$ -
TSF-L59	L59-2	\$ -	\$ -	\$ -	\$ -	\$ -	\$ -
TSF-L60	L60-1	\$ -	\$ 11,000	\$ -	\$ -	\$ -	\$ -
TSF-L61	L61-1	\$ -	\$ -	\$ -	\$ -	\$ -	\$ -
		\$ 912,000	\$ 264,000	\$ -	\$ -	\$ 2,541,000	\$ 2,475,000
			\$ 466,000		\$ 75,588,700		\$ 49,750,000

ATTACHMENT G-Projects
41 of 42

SUBSTATION	CKT	Grounding Transformer Cost (\$)		Distribution Transformer Cost (\$)		Pole and Secondary Cost (\$)		2030 Distribution Xfmr Upgrade (\$)	2030 Distribution Xfmr Upgrade (\$)	2030 Distribution Xfmr Upgrade (\$)
		2016 Grounding Xfmr Addition (\$)	2020 Grounding Xfmr Addition (\$)	2016 Distribution Xfmr Upgrade (\$)	2020 Distribution Xfmr Upgrade (\$)	2016 Distribution Xfmr Upgrade (\$)	2020 Distribution Xfmr Upgrade (\$)			
Hawaiian Electric										
TSF-L56	L56-1	\$ -	\$ -	\$ -	\$ -	\$ -	\$ -	\$ -	\$ -	\$ -
TSF-L57	L57-1	\$ -	\$ -	\$ -	\$ -	\$ 1,294.99	\$ 445	\$ 310.80	\$ 107	\$ 7
TSF-L57	L57-2	\$ -	\$ -	\$ -	\$ -	\$ 7,182.73	\$ 5,318	\$ 1,723.86	\$ 1,276	\$ 80
TSF-L58	L58-1	\$ -	\$ -	\$ -	\$ -	\$ 791.16	\$ 1,534	\$ 189.88	\$ 368	\$ 23
TSF-L59	L59-1	\$ -	\$ -	\$ -	\$ -	\$ 5,632.53	\$ 9,062	\$ 1,351.81	\$ 2,175	\$ 136
TSF-L59	L59-2	\$ -	\$ -	\$ -	\$ -	\$ 23,076.68	\$ 13,148	\$ 5,538.40	\$ 3,156	\$ 197
TSF-L60	L60-1	\$ 66,000	\$ -	\$ -	\$ -	\$ -	\$ 1,808	\$ -	\$ 434	\$ 25
TSF-L61	L61-1	\$ -	\$ -	\$ -	\$ -	\$ -	\$ -	\$ -	\$ -	\$ -
		\$ 33,033,000	\$ 6,095,100	\$ 3,917,100	\$ 4,462,164	\$ 4,386,633	\$ 6,768,738	\$ 1,016,605	\$ 993,371	\$ 1,523,365

SUBSTATION	CKT	Regulator Cost (\$)		Upgrade Costs By Year (\$)			Total Cost of Upgrades (\$)
		2016 Regulator Upgrade (\$)	2030 Regulator Upgrade (\$)	2016 Total Cost of Upgrades (\$)	2020 Total Cost of Upgrades (\$)	2030 Total Cost of Upgrades (\$)	
Hawaiian Electric							
TSF-L56	L56-1	\$ -	\$ -	\$ -	\$ -	\$ -	\$ -
TSF-L57	L57-1	\$ -	\$ -	\$ 12,606	\$ 552	\$ 34	\$ 13,192
TSF-L57	L57-2	\$ -	\$ -	\$ 8,907	\$ 6,595	\$ 412	\$ 15,913
TSF-L58	L58-1	\$ -	\$ -	\$ 11,981	\$ 1,902	\$ 119	\$ 14,002
TSF-L59	L59-1	\$ -	\$ -	\$ 17,984	\$ 11,237	\$ 701	\$ 29,923
TSF-L59	L59-2	\$ -	\$ -	\$ 28,615	\$ 16,304	\$ 1,017	\$ 45,937
TSF-L60	L60-1	\$ -	\$ -	\$ 66,000	\$ 2,242	\$ 11,128	\$ 79,370
TSF-L61	L61-1	\$ -	\$ -	\$ -	\$ -	\$ -	\$ -
		\$ 187,000	\$ 55,000	\$ 42,151,769	\$ 14,269,104	\$ 138,079,904	\$ 194,500,777

SUBSTATION	GKT	Primary Voltage (kV)	Existing installed Based on NEM Data (kW)	Approved DG [kW]	In process [kW]	Total DG (kW) on Primary			Total DG kW on Primary			Total DG kW on Primary			Existing Primary Min Load (kVA)	Existing Primary Peak Load (kVA)
						-2014	-2016	-2030	Short Term	Mid Term	Long Term	Short Term	Mid Term	Long Term		
Hawaiian Electric																
TSF-H1	H1-1	12.47	1060	73	138	1350.33	1520.6	1974.8	2845.8	970	2424					
TSF-H1	H1-2	12.47	1188	125	106	1513.29	1704.1	2213.1	3189.3	1268	3170					
TSF-H2	H2-1	12.47	1618	120	353	2061.06	2354.0	3057.1	4405.5	1670	4176					
TSF-H2	H2-2	12.47	469	58	0	597.01	672.3	873.1	1258.2	2005	5012					
TSF-H3	H3-1	11.5	584	35	0	744.46	838.3	1088.7	1569.0	1326	3314					
TSF-H3	H3-2	11.5	1047	18	391	1334.30	1640.3	2130.2	3069.8	946	2364					
TSF-H4	H4-1	11.5	1385	65	450	1764.84	2140.0	2779.2	4005.0	1242	3105					
TSF-H4	H4-2	11.5	217	116	10	276.67	386.7	502.2	723.8	1638	4095					
TSF-H5	H5-1	11.5	289	14	7	367.66	414.0	537.7	774.8	908	2271					
TSF-H5	H5-2	11.5	48	100	7	60.72	166.3	216.0	311.2	229	573					
TSF-H6	H6-1	4.16	468	63	56	596.53	671.7	872.4	1257.2	685	1713					
TSF-H7	H7-1	4.16	421	7	153	536.20	654.5	849.9	1224.8	418	1046					
TSF-H8	H8-1	4.16	897	8	276	1142.58	1329.0	1726.0	2487.2	586	1464					
TSF-H9	H9-1	12.47	845	192	0	1076.46	1212.2	1574.3	2268.7	1402	3505					
TSF-H9	H9-2	12.47	660	321	0	840.73	1104.7	1484.7	2067.5	1502	3755					
TSF-H10	H10-1	4.16	207	22	0	263.29	296.5	385.1	554.9	243	607					
TSF-H11	H11-1	11.5	0	0	850	0.00	957.2	1243.1	1791.4	1145	2862					
TSF-H12	H12-1	11.5	0	0	250	0.00	281.5	365.6	526.9	1766	4414					
TSF-H13	H13-1	11.5	272	10	0	346.82	390.5	507.2	730.9	2154	5385					
TSF-H13	H13-2	11.5	0	178	0	0.00	200.4	260.3	375.1	1686	4215					
TSF-H14	H14-1	12.47	1914	8	106	2437.61	2744.9	3564.9	5137.3	1896	4739					
TSF-H15	H15-1	12.47	1003	0	0	1278.04	1439.2	1869.1	2693.5	1792	4479					
TSF-H15	H15-2	12.47	114	86	60	145.22	292.2	379.4	546.8	309	772					
TSF-H16	H16-1	12.47	0	0	154	0.00	173.4	225.2	324.6	1353	3383					
TSF-H17	H17-1	12.47	0	6	0	0.00	6.8	8.8	12.6	1112	2780					
TSF-H18	H18-1	12.47	1052	240	260	1339.78	1747.8	2269.9	3271.0	1698	4246					
TSF-H18	H18-2	12.47	938	99	204	1195.19	1398.0	1815.6	2616.4	1073	2682					
TSF-H19	H19-1	12.47	960	46	412	1222.68	1597.1	2074.2	2989.1	1078	2695					
TSF-H19	H19-2	12.47	1573	83	492	2003.51	2418.8	3141.3	4526.8	1772	4430					
TSF-H20	H20-1	12.47	943	116	28	1201.48	1353.0	1757.1	2532.1	1436	3590					
TSF-H21	H21-1	12.47	1668	270	123	2124.86	2392.8	3107.5	4478.2	1836	4590					
TSF-H22	H22-1	11.5	4	0	0	4.66	5.3	6.8	9.8	2187						
TSF-H22	H22-2	11.5	125	36	84	158.95	275.8	358.2	516.1	2129	5322					
TSF-H23	H23-1	11.5	171	39	245.0	217.61	245.0	318.2	458.6	1177	2943					
TSF-H23	H23-2	11.5	190	0	0	242.03	272.5	354.0	510.1	837	2092					
TSF-H24	H24-1	4.16	368	60	0	468.81	527.9	685.6	988.0	587	1468					
TSF-H24	H24-2	4.16	263	45	0	335.03	377.3	490.0	706.1	326	815					
TSF-H25	H25-1	12.47	1090	152	273	1389.05	1705.8	2215.4	3192.5	1265	3162					
TSF-H25	H25-2	12.47	1398	81	405	1780.74	2120.6	2754.0	3968.7	1388	3469					
TSF-H26	H26-1	12.47	1411	23	417	1797.35	2084.2	2706.8	3900.7	1095	2738					
TSF-H26	H26-2	12.47	796	151	17	1014.20	1142.1	1483.2	2137.4	1065	2662					
TSF-H27	H27-1	11.5	827	114	40	1054.04	1186.9	1541.5	2221.4	1091	2728					
TSF-H27	H27-2	11.5	948	175	29	1207.84	1360.1	1766.4	2545.5	1523	3807					
TSF-H28	H28-1	11.5	812	261	131	1034.42	1356.1	1761.1	2537.9	1528	3819					

SUBSTATION	CKT	Primary Voltage (kV)	Existing installed Based on NEM Data (kW)	Approved DG [kW]	In process [kW]	Total DG (kW) on Primary -2014		Total DG kW on Primary -2016		Total DG kW on Primary -2020		Total DG kW on Primary -2030		Existing Primary Min Load (kVA)	Existing Primary Peak Load (kVA)
						Short Term	Mid Term	Short Term	Mid Term	Long Term	Long Term				
TSF-H28	H28-2	11.5	721	95	0	918.52	1034.3	1343.3	1935.8	1430	3575				
TSF-H29	H29-1	4.16	8	0	0	10.41	11.7	15.2	230	230	576				
TSF-H30	H30-1	11.5	343	266	0	436.92	685.8	890.6	1283.5	2224	5559				
TSF-H30	H30-2	11.5	508	341	118	647.32	1089.0	1414.3	2038.1	1594	3985				
TSF-H31	H31-1	12.47	525	0	0	668.51	752.8	977.7	1408.9	1270	3174				
TSF-H32	H32-1	12.47	23	4	0	29.69	33.4	43.4	62.6	66	166				
TSF-H33	H33-1	11.5	351	9	0	446.53	502.8	653.0	941.1	830	2074				
TSF-H33	H33-2	11.5	1381	225	115	1758.85	1980.6	2572.2	3706.8	1426	3566				
TSF-H34	H34-1	11.5	537	115	37	683.53	774.8	1006.3	1450.1	1562	3906				
TSF-H34	H34-2	11.5	0	0	0	0.00	0.0	0.0	0.0	1328	3320				
TSF-H35	H35-1	11.5	709	51	0	903.77	1017.7	1321.7	1904.7	2024	5059				
TSF-H36	H36-1	12.47	988	165	144	1259.07	1460.4	1896.7	2733.2	1674	4186				
TSF-H36	H36-2	12.47	709	9	0	903.20	1017.1	1320.9	1903.5	1502	3756				
TSF-H37	H37-1	12.47	200	0	333	255.38	600.5	779.9	1123.9	376	940				
TSF-H37	H37-2	12.47	199	6	0	253.43	285.4	370.6	534.1	1002	2506				
TSF-H38	H38-1	11.5	323	0	65	411.94	463.9	602.4	868.2	2270	5675				
TSF-H39	H39-1	11.5	985	100	100	1254.77	1413.0	1835.0	2644.4	2014	5034				
TSF-H39	H39-2	11.5	116	92	0	147.78	234.1	304.0	438.1	277	693				
TSF-H40	H40-1	11.5	656	15	143	835.87	941.3	1222.4	1761.6	1861	4652				
TSF-H40	H40-2	11.5	160	9	0	203.24	228.9	297.2	428.3	1963	4908				
TSF-H41	H41-1	24.94	246	0	0	312.83	352.3	457.5	659.3	582	1456				
TSF-H42	H42-1	12.47	897	139	200	1142.19	1391.1	1806.7	2603.5	1640	4100				
TSF-H43	H43-1	4.16	335	0	47	426.11	479.8	623.2	898.0	427	1067				
TSF-H43	H43-2	4.16	397	35	55	506.32	570.2	740.5	1067.1	427	1067				
TSF-H43	H43-3	4.16	660	3	235	840.66	1011.8	1314.1	1893.7	627	1567				
TSF-H44	H44-1	12.47	488	141	0	621.33	708.6	920.2	1326.1	343	858				
TSF-H44	H44-2	12.47	1199	122	78	1527.10	1719.6	2233.3	3218.4	2217	5542				
TSF-H45	H45-1	4.16	523	3	91	666.18	750.2	974.3	1404.0	429	1072				
TSF-H45	H45-2	4.16	373	7	114	474.98	556.2	722.4	1041.0	382	954				
TSF-H45	H45-3	4.16	386	20	61	491.60	553.6	718.9	1036.1	268	670				
TSF-H46	H46-1	12.47	387	253	0	493.17	720.8	936.1	1349.0	2068	5171				
TSF-H46	H46-2	12.47	1129	270	206	1437.88	1807.3	2347.1	3382.4	1527	3818				
TSF-H47	H47-1	11.5	798	78	154	1016.64	1160.3	1506.9	2171.6	1342	3355				
TSF-H47	H47-2	11.5	884	8	427	1125.77	1484.8	1928.4	2778.9	1198	2995				
TSF-H48	H48-1	12.47	1030	214	46	1312.49	1478.0	1919.5	2766.1	1366	3415				
TSF-H48	H48-2	12.47	1225	375	66	1560.08	1875.9	2436.2	3510.8	1703	4257				
TSF-H49	H49-1	4.16	405	76	64	515.42	613.4	796.6	1148.0	490	1224				
TSF-H50	H50-1	4.16	269	52	12	342.19	385.3	500.4	721.2	420	1049				
TSF-H51	H51-1	4.16	432	3	125	549.75	630.5	818.8	1180.0	319	798				
TSF-H51	H51-2	4.16	196	48	0	249.25	280.7	364.5	525.3	199	497				
TSF-H52	H52-1	4.16	115	18	111	146.25	274.5	356.4	513.7	92	231				
TSF-H52	H52-2	4.16	324	14	40	412.69	464.7	603.5	869.7	342	854				
TSF-H53	H53-1	4.16	226	50	0	287.79	324.1	420.9	606.5	598	1495				
TSF-H53	H53-2	4.16	8	0	0	10.19	11.5	14.9	21.5	743	1857				
TSF-H53	H53-3	4.16	24	0	0	30.39	34.2	44.4	64.1	788	1969				
TSF-H54	H54-1	11.5	6	0	0	8.11	9.1	11.9	17.1	262	654				
TSF-H55	H55-1	11.5	96	0	0	122.45	137.9	179.1	258.1	1233	3083				
TSF-H55	H55-2	11.5	181	40	0	230.46	259.5	337.0	485.7	2080	5199				
TSF-H55	H55-3	11.5	0	49	0	0.00	55.3	71.8	103.5	1161	2902				
TSF-H56	H56-1	12.47	241	0	0	307.00	345.7	449.0	647.0	573	1433				
TSF-H57	H57-1	4.16	680	20	171	866.43	981.4	1274.6	1836.8	559	1397				

SUBSTATION	CKT	Primary Voltage (kV)	Existing installed Based on NEM Data (kW)	Approved DG [kW]	In process [kW]	Total DG (kW) on Primary -2014		Total DG kW on Primary -2016		Total DG kW on Primary -2020		Total DG kW on Primary -2030		Existing Primary Min Load (kVA)	Existing Primary Peak Load (kVA)
						Primary -2014	Short Term	Primary -2016	Mid Term	Primary -2020	Long Term	Primary -2030	Long Term		
TSF-H57	H57-2	4.16	382	99	94	487.03	579.5	752.7	1084.6	415	1038				
TSF-H58	H58-1	4.16	571	12	159	727.53	836.0	1085.7	1564.5	404	1011				
TSF-H59	H59-1	4.16	168	29	214.22	241.2	313.3	451.5	424	236	591				
TSF-H59	H59-2	4.16	111	32	140.85	278.3	361.5	520.9	374.7	351	878				
TSF-H60	H60-1	4.16	61	17	77.16	200.2	260.0	374.7	374.7	351	878				
TSF-H60	H60-2	4.16	187	219	237.70	650.7	845.0	1217.7	535	1338	3547				
TSF-H61	H61-1	12.47	1541	28	424	1963.62	2244.3	2914.7	4200.2	1419	3547				
TSF-H61	H61-2	12.47	918	3	393	1169.85	1480.2	1922.3	2770.2	730	1824				
TSF-H62	H62-1	4.16	275	105	12	349.70	441.2	572.9	825.7	400	1000				
TSF-H62	H62-2	4.16	254	62	0	323.35	364.1	472.9	681.5	569	1422				
TSF-H63	H63-1	4.16	327	110	0	417.11	492.9	640.1	922.5	708	1769				
TSF-H64	H64-1	12.47	165	138	0	210.58	341.6	443.6	639.2	1772	4429				
TSF-H64	H64-2	12.47	895	206	56	1140.42	1303.2	1692.5	2439.0	759	1898				
TSF-H65	H65-1	12.47	198	0	0	252.74	284.6	369.6	532.7	1229	3072				
TSF-H65	H65-2	12.47	897	87	273	1142.81	1416.1	1839.1	2650.3	648	1621				
TSF-H66	H66-1	12.47	998	0	0	1271.48	1431.8	1859.5	2679.6	664	1660				
TSF-H66	H66-2	12.47	449	168	7	571.82	703.1	913.1	1315.9	668	1671				
TSF-H67	H67-1	24.94	350	0	0	445.85	502.1	652.0	939.6	1962	4904				
TSF-H67	H67-2	24.94	0	0	150	0.00	168.9	219.4	316.1	1914	4786				
TSF-H68	H68-1	12.47	1496	450	315	1905.55	2545.4	3305.8	4763.9	2087	5218				
TSF-H68	H68-2	12.47	713	45	182	907.83	1058.1	1374.2	1980.3	843	2107				
TSF-H69	H69-1	12.47	1248	144	52	1589.39	1789.8	2324.4	3349.6	1803	4508				
TSF-H69	H69-2	12.47	426	194	0	542.62	698.5	907.1	1307.2	1122	2805				
TSF-H70	H70-1	12.47	647	68	387	824.22	1240.9	1611.5	2322.3	872	2179				
TSF-H70	H70-2	12.47	237	35	0	301.63	339.7	441.1	635.7	1713	4283				
TSF-H71	H71-1	11.5	100	7	143.4	127.38	143.4	186.3	268.5	700	1749				
TSF-H71	H71-2	11.5	1612	148	114	2052.89	2311.7	3002.3	4326.5	1638	4095				
TSF-H72	H72-1	11.5	365	21	0	465.29	524.0	680.5	980.6	1565	3912				
TSF-H72	H72-2	11.5	4	5	0	4.71	9.5	12.3	17.8	1048	2621				
TSF-H73	H73-1	12.47	1244	155	183	1585.28	1785.2	2318.4	3341.0	1797	4493				
TSF-H73	H73-2	12.47	0	133	0	0.00	149.3	193.9	279.4	539	1348				
TSF-H74	H74-1	12.47	885	104	24	1127.38	1269.5	1648.7	2376.0	1162	2906				
TSF-H75	H75-1	12.47	33	0	0	42.56	47.9	62.2	88.7	1461	3653				
TSF-H76	H76-1	12.47	185	26	6	235.04	264.7	343.7	495.3	1629	4073				
TSF-H77	H77-1	12.47	63	36	14	80.02	126.9	164.9	237.6	970	2426				
TSF-H78	H78-1	12.47	24	0	0	30.50	34.3	44.6	64.3	1366	3415				
TSF-H79	H79-1	11.5	269	55	0	342.82	386.0	501.4	722.5	1096	2739				
TSF-H79	H79-2	11.5	337	18	0	429.48	483.6	628.1	905.1	1944	4859				
TSF-H80	H80-1	11.5	432	0	0	550.70	620.1	805.4	1160.6	1296	3241				
TSF-H80	H80-2	11.5	1316	74	100	1676.27	1887.6	2451.5	3532.7	2103	5258				
TSF-H81	H81-1	11.5	1009	9	0	1285.78	1447.9	1880.4	2709.8	1098	2745				
TSF-H81	H81-2	11.5	1262	18	217	1607.28	1809.9	2350.6	3387.3	2384	5961				
TSF-H82	H82-1	12.47	301	31	45	383.61	561.0	744.6	1046.6	1496	3740				
TSF-H82	H82-2	12.47	440	9	0	560.16	630.8	819.2	1180.5	2244	5611				
TSF-H83	H83-1	4.16	375	29	34	477.07	537.2	697.7	1005.4	489	1248				
TSF-H83	H83-2	4.16	40	0	0	50.95	57.4	74.5	107.4	187	468				
TSF-H83	H83-3	4.16	60	0	13	76.19	85.8	111.4	160.6	39	98				
TSF-H84	H84-1	12.47	196	47	14	249.79	289.4	375.8	541.6	1246	3114				
TSF-H84	H84-2	12.47	1051	51	106	1339.33	1508.2	1958.7	2822.7	1594	3986				
TSF-H85	H85-1	4.16	4	0	100	5.48	117.4	152.5	219.8	226	565				
TSF-H85	H85-2	4.16	178	100	0	226.29	312.6	406.0	585.1	474	1185				

SUBSTATION	CKT	Primary Voltage (kV)	Existing installed Based on NEM Data (kW)	Approved DG [kW]	In process [kW]	Total DG (kW) on Primary -2014		Total DG kW on Primary -2016		Total DG kW on Primary -2020		Total DG kW on Primary -2030		Existing Primary Min Load (kVA)	Existing Primary Peak Load (kVA)
						Short Term	Mid Term	Short Term	Long Term	Short Term	Long Term	Short Term	Long Term		
TSF-H86	H86-1	12.47	211	6	114	268.92	372.8	484.2	697.8	156	390				
TSF-H87	H87-1	11.5	350	12	0	445.85	502.1	939.6	879	1914	2197				
TSF-H88	H88-1	11.5	943	0	0	1201.01	1756.4	1756.4	2531.1	1914	4786				
TSF-H89	H89-1	11.5	79	0	442	0.00	497.7	646.4	931.5	93	232				
TSF-H90	H90-1	11.5	368	0	0	468.46	527.5	113.4	147.3	1173	2933				
TSF-H91	H91-1	12.47	1502	132	377	1913.84	2265.3	2941.9	4239.5	1534	3834				
TSF-H92	H92-1	12.47	1529	150	250	1947.90	2193.5	2848.7	4105.2	1322	3304				
TSF-H93	H93-1	12.47	1861	130	389	2370.95	2681.0	3481.9	5017.7	1671	4177				
TSF-H94	H94-1	12.47	871	18	51	1109.94	1249.9	1623.2	2339.2	1289	3223				
TSF-H95	H95-1	12.47	4	105	0	5.48	122.7	101.2	145.9	1172	2931				
TSF-H96	H96-1	24.94	200	100	0	254.77	337.8	438.7	632.3	2600	6499				
TSF-H97	H97-1	12.47	1542	350	52	1963.66	2211.2	2871.8	4138.4	1360	3401				
TSF-H98	H98-1	12.47	849	86	10	1081.65	1218.0	1581.9	2279.6	1164	2909				
TSF-H99	H99-1	12.47	1466	397	30	1867.65	2103.1	2731.4	3936.1	1344	3361				
TSF-H100	H100-1	12.47	926	121	15	1179.12	1327.8	1724.4	2485.0	1136	2840				
TSF-H101	H101-1	11.5	293	114	12	373.01	472.1	613.2	883.6	968	2420				
TSF-H102	H102-1	12.47	782	27	272	995.75	1216.9	1580.4	2277.5	838	2094				
TSF-H103	H103-2	12.47	1410	42	467	1796.53	2161.0	2806.5	4044.4	1841	4603				
TSF-H104	H104-2	12.47	673	6	211	857.91	1003.1	1302.7	1877.3	509	1273				
TSF-H105	H105-1	4.16	230	123	0	292.88	397.0	515.6	743.0	510	1274				
TSF-H106	H106-1	4.16	107	14	98	135.68	246.6	320.2	461.5	311	778				
TSF-H107	H107-1	11.5	284	61	0	361.72	407.3	529.0	762.3	276	691				
TSF-H108	H108-1	11.5	600	117	50	764.31	860.7	1117.8	1610.8	722	1805				
TSF-H109	H109-1	11.5	186	0	13	1444.26	1626.4	2112.2	3043.8	1466	3664				
TSF-H110	H110-1	11.5	62	0	0	79.18	89.2	346.8	495.8	725	1813				
TSF-H111	H111-1	11.5	993	82	3	1265.25	1424.8	1850.4	2666.5	1051	2628				
TSF-H112	H112-1	12.47	1008	388	91	1283.86	1675.0	2175.3	3134.8	2505	6262				
TSF-H113	H113-1	12.47	52	8	0	66.06	74.4	96.6	139.2	1484	3709				
TSF-H114	H114-1	12.47	1023	98	683	1303.69	2032.5	2639.6	3803.8	2488	6221				
TSF-H115	H115-1	12.47	817	131	218	1040.92	1313.4	1705.7	2458.1	1360	3400				
TSF-H116	H116-1	12.47	1372	135	191	1747.79	1968.2	2556.1	3683.5	1568	3920				
TSF-H117	H117-1	12.47	1660	538	49	2114.42	2530.4	3286.2	4735.7	1434	3585				
TSF-H118	H118-1	12.47	467	69	30	595.09	670.1	870.3	1254.2	750	1875				
TSF-H119	H119-1	11.5	1248	109	37	1590.00	1790.5	2325.3	3350.9	2411	6027				
TSF-H120	H120-1	11.5	972	188	172	1238.50	1500.1	1948.2	2807.5	963	2407				
TSF-H121	H121-1	11.5	1356	0	0	1726.97	1944.7	2525.6	3639.6	1703	4257				
TSF-H122	H122-1	11.5	1427	118	347	1817.82	2130.6	2767.0	3987.5	1297	3243				
TSF-H123	H123-1	12.47	77	0	0	97.50	109.8	142.6	205.5	845	2113				
TSF-H124	H124-1	12.47	153	0	0	194.90	219.5	285.0	410.7	947	2367				
TSF-H125	H125-1	12.47	175	0	0	222.92	251.0	326.0	469.8	1005	2512				

SUBSTATION	CKT	Existing Sub						Existing Sub				Existing Sub				2016 Short Term			
		Existing DG on Sub XFMR	Existing DG XFMR Min Load (kVA)	Existing Sub XFMR Min Load (kVA)	Existing Sub XFMR Peak Load (kVA)	Remaining DG kW to 100% Gross DML	Existing Sub XFMR kW to 100% Gross DML	Existing 50% Sub XFMR MVA	Existing DG to 50% Substation XFMR Rating (kW)	2016 DG on Sub XFMR	2016 Sub XFMR Min Load (kVA)	2016 Sub XFMR Peak Load (kVA)	2016 DML-DG	2016 DG on Sub XFMR	2016 Sub XFMR Min Load (kVA)	2016 Sub XFMR Peak Load (kVA)	2016 DML-DG	2016 Short Term Remaining DG to 50% Substation XFMR Rating (kW)	
TSF-H86	H86-1	269	156	390	446	-113	5	4887	373	160	400	-213	4787					4787	
TSF-H87	H87-1	446	879	2197	433	713	5	5433	502	901	2253	399	5399					5399	
TSF-H88	H88-1	1201	1914	4786	713	713	5	5713	1352	1963	4908	611	5611					5611	
TSF-H89	H89-1																		
TSF-H89	H89-2																		
TSF-H90	H90-1	468	1266	3165	5890	1888	5	6165	611	1298	3246	687	5687					5687	
TSF-H91	H91-1																		
TSF-H91	H91-2	3862	2855	7138	1007	-1007	5	3993	4459	2928	7321	-1531	3469					3469	
TSF-H92	H92-1																		
TSF-H92	H92-2	3481	2960	7400	521	-521	5	4479	3931	3036	7589	-895	4105					4105	
TSF-H93	H93-1	23	1172	2931	1150	1150	5	6150	78	1202	3006	1124	6124					6124	
TSF-H94	H94-1	5	936	2339	930	930	5	5930	123	960	2399	837	5837					5837	
TSF-H95	H95-1																		
TSF-H95	H95-2	579	4032	10080	3453	3453	15	18453	703	4135	10338	3432	18432					18432	
TSF-H96	H96-1	179	1954	4884	1774	1774	5	6774	202	2004	5009	1802	6802					6802	
TSF-H97	H97-1	3991	3174	7936	817	-817	5	4183	4494	3256	8139	-1239	3761					3761	
TSF-H98	H98-1																		
TSF-H98	H98-2																		
TSF-H99	H99-1																		
TSF-H99	H99-2	1587	2468	6169	881	881	5	5881	1787	2531	6327	744	5744					5744	
TSF-H99	H99-2	3047	2480	6201	566	-566	5	4434	3431	2544	6360	-887	4113					4113	
TSF-H100	H100-1	49	1374	3435	1325	1325	5	6325	55	1409	3523	1354	6354					6354	
TSF-H101	H101-1	373	968	2420	595	595	3	2482	472	993	2482	521	3021					3021	
TSF-H102	H102-1	0	466	1166	466	466	3	2966	27	478	1196	451	2951					2951	
TSF-H103	H103-1																		
TSF-H103	H103-2	2792	2679	6697	-113	-113	5	4887	3378	2747	6868	-631	4369					4369	
TSF-H104	H104-1																		
TSF-H104	H104-2	2817	2252	5629	-563	-563	5	4435	3209	2309	5773	-900	4100					4100	
TSF-H105	H105-1	293	510	1274	217	217	1	1079	397	523	1307	126	988					988	
TSF-H106	H106-1																		
TSF-H106	H106-2	344	588	1469	244	244	2	2119	502	603	1507	100	1975					1975	
TSF-H107	H107-1																		
TSF-H107	H107-2	1126	1805	4512	679	679	5	5679	1268	1851	4627	583	5583					5583	
TSF-H108	H108-1																		
TSF-H108	H108-2	1681	2191	5477	509	509	5	5509	1893	2247	5617	353	5353					5353	
TSF-H109	H109-1																		
TSF-H109	H109-2	1344	2694	6734	1349	1349	5	6349	1514	2762	6906	1249	6249					6249	
TSF-H110	H110-1	1284	2505	6262	1221	1221	5	6221	1675	2569	6422	894	5894					5894	
TSF-H111	H111-1																		
TSF-H111	H111-2	1370	3972	9930	2602	2602	5	7602	2107	4074	10184	1967	6967					6967	
TSF-H112	H112-1																		
TSF-H112	H112-2	2789	2928	7320	139	139	5	5139	3282	3003	7507	-279	4721					4721	
TSF-H113	H113-1																		
TSF-H113	H113-2	2710	2184	5460	-526	-526	5	4474	3201	2240	5600	-961	4039					4039	
TSF-H114	H114-1																		
TSF-H114	H114-2	2828	3374	8434	545	545	5	5545	3291	3460	8650	169	5169					5169	
TSF-H115	H115-1																		
TSF-H115	H115-2	3545	3000	7500	-545	-545	5	4455	4075	3077	7692	-999	4001					4001	
TSF-H116	H116-1																		
TSF-H116	H116-2	292	1792	4480	1500	1500	5	6500	329	1838	4595	1509	6509					6509	
TSF-H117	H117-1	223	1005	2512	782	782	5	5782	251	1030	2576	779	5779					5779	

SUBSTATION	CKT	2020 DG on Sub XFMR				2020 Sub XFMR				2020 DML-DG				2020 Midterm Remaining DG to 50% Substation XFMR Rating (kW)				2030 DG on Sub XFMR				2030 DML-DG				2030 Long Term Remaining DG to 50% Substation XFMR Rating (kW)							
		Sub XFMR	Min Load (kVA)	2020 Sub XFMR Peak Load (kVA)	2020 Sub XFMR Peak Load (kVA)	Min Load (kVA)	2020 Sub XFMR Peak Load (kVA)	2020 Sub XFMR Peak Load (kVA)	2020 Sub XFMR Peak Load (kVA)	Sub XFMR	Min Load (kVA)	2020 DML-DG	2020 DML-DG	2020 DML-DG	2020 DML-DG	Sub XFMR	Min Load (kVA)	2020 Sub XFMR Peak Load (kVA)	2020 Sub XFMR Peak Load (kVA)	Sub XFMR	Min Load (kVA)	2020 DML-DG	2020 DML-DG	2020 DML-DG	2020 DML-DG	Sub XFMR	Min Load (kVA)	2020 Sub XFMR Peak Load (kVA)	2020 Sub XFMR Peak Load (kVA)	Sub XFMR	Min Load (kVA)	2020 DML-DG	2020 DML-DG
TSF-H86	H86-1	484	165	412	412	480	480	480	480	480	480	-320	4680	4680	698	124	310	310	698	124	310	-574	4426	4426									
TSF-H87	H87-1	652	927	2319	2319	5275	5275	5275	5275	5275	5275	-241	4759	4759	940	699	1746	1746	940	699	1746	-241	4759	4759									
TSF-H88	H88-1	1756	2020	5051	5051	5264	5264	5264	5264	5264	264	3804	3804	2531	1522	3804	3804	2531	1522	3804	-1009	3991	3991										
TSF-H89	H89-1	794	1336	3340	3340	5542	5542	5542	5542	5542	542	4863	4863	1144	1006	2516	2516	1144	1006	2516	-137	4863	4863										
TSF-H90	H90-1	685	2487	6216	6216	6801	6801	6801	6801	6801	1801	5885	5885	987	1873	4682	4682	987	1873	4682	885	5885	5885										
TSF-H91	H91-1	5791	3013	7534	7534	2223	2223	2223	2223	2223	-2777	8345	8345	8345	2270	5674	5674	8345	2270	5674	-6075	-1075	-1075										
TSF-H92	H92-1	5105	3124	7810	7810	3019	3019	3019	3019	3019	-1981	7357	7357	7357	2353	5882	5882	7357	2353	5882	-5004	-4	-4										
TSF-H93	H93-1	101	1237	3093	3093	6136	6136	6136	6136	6136	1136	5786	5786	146	932	2330	2330	146	932	2330	786	5786	5786										
TSF-H94	H94-1	159	987	2469	2469	5828	5828	5828	5828	5828	828	5514	5514	230	744	1859	1859	230	744	1859	514	5514	5514										
TSF-H95	H95-1	913	4255	10639	10639	18342	18342	18342	18342	18342	3342	16889	16889	1316	3205	8012	8012	1316	3205	8012	1889	16889	16889										
TSF-H96	H96-1	262	2062	5155	5155	6800	6800	6800	6800	6800	1800	6175	6175	378	1553	3882	3882	378	1553	3882	1175	6175	6175										
TSF-H97	H97-1	5837	3350	8376	8376	2514	2514	2514	2514	2514	-2486	8411	8411	8411	2523	6308	6308	8411	2523	6308	-5888	-888	-888										
TSF-H98	H98-1	2321	2604	6511	6511	5283	5283	5283	5283	5283	283	3617	3617	3345	1961	4904	4904	3345	1961	4904	-1383	3617	3617										
TSF-H99	H99-1	4456	2618	6545	6545	3162	3162	3162	3162	3162	-1838	6421	6421	6421	1972	4929	4929	6421	1972	4929	-4449	551	551										
TSF-H100	H100-1	72	1450	3625	3625	6378	6378	6378	6378	6378	1378	5989	5989	104	1092	2730	2730	104	1092	2730	989	5989	5989										
TSF-H101	H101-1	613	1022	2554	2554	2908	2908	2908	2908	2908	408	2386	2386	884	769	1924	1924	884	769	1924	-114	2386	2386										
TSF-H102	H102-1	35	492	1231	1231	2957	2957	2957	2957	2957	457	2820	2820	51	371	927	927	51	371	927	320	2820	2820										
TSF-H103	H103-1	4387	2827	7068	7068	3440	3440	3440	3440	3440	-1560	6322	6322	6322	2129	5323	5323	6322	2129	5323	-4193	807	807										
TSF-H104	H104-1	4168	2376	5941	5941	3209	3209	3209	3209	3209	-1791	6006	6006	6006	1790	4474	4474	6006	1790	4474	-4216	784	784										
TSF-H105	H105-1	516	538	1345	1345	885	885	885	885	885	22	525	525	743	405	1013	1013	743	405	1013	-338	525	525										
TSF-H106	H106-1	653	620	1550	1550	1843	1843	1843	1843	1843	-32	940	940	940	467	1168	1168	940	467	1168	-473	1402	1402										
TSF-H107	H107-1	1647	1905	4762	4762	5258	5258	5258	5258	5258	258	4061	4061	2373	1435	3587	3587	2373	1435	3587	-939	4061	4061										
TSF-H108	H108-1	2459	2312	5780	5780	4853	4853	4853	4853	4853	-147	3544	3544	3544	1741	4354	4354	3544	1741	4354	-1802	3198	3198										
TSF-H109	H109-1	1966	2843	7107	7107	5877	5877	5877	5877	5877	877	4308	4308	2833	2141	5353	5353	2833	2141	5353	-692	4308	4308										
TSF-H110	H110-1	2175	2644	6609	6609	5468	5468	5468	5468	5468	468	3856	3856	3135	1991	4978	4978	3135	1991	4978	-1144	3856	3856										
TSF-H111	H111-1	2736	4192	10480	10480	6456	6456	6456	6456	6456	1456	4214	4214	3943	3157	7893	7893	3943	3157	7893	-786	4214	4214										
TSF-H112	H112-1	4262	3090	7726	7726	3828	3828	3828	3828	3828	-1172	6142	6142	6142	2327	5819	5819	6142	2327	5819	-3814	1186	1186										
TSF-H113	H113-1	4157	2305	5763	5763	3148	3148	3148	3148	3148	-1852	5990	5990	5990	1736	4340	4340	5990	1736	4340	-4254	746	746										
TSF-H114	H114-1	4273	3561	8901	8901	4287	4287	4287	4287	4287	-713	6158	6158	6158	2682	6704	6704	6158	2682	6704	-3477	1523	1523										
TSF-H115	H115-1	5293	3166	7916	7916	2874	2874	2874	2874	2874	-2126	7627	7627	7627	2385	5962	5962	7627	2385	5962	-5242	-242	-242										
TSF-H116	H116-1	428	1891	4728	4728	6464	6464	6464	6464	6464	1464	5808	5808	616	1424	3561	3561	616	1424	3561	808	5808	5808										
TSF-H117	H117-1	326	1060	2651	2651	5734	5734	5734	5734	5734	734	5329	5329	470	799	1997	1997	470	799	1997	329	5329	5329										

SUBSTATION	CKT	Primary Voltage (kV)	Existing installed Based on NEM Data (kW)	Approved DG [kW]	In process [kW]	Total DG (kW) on Primary -2014		Total DG kW on Primary -2016		Total DG kW on Primary -2020		Existing Primary Min Load (kVA)	
						0	100	112.6	146.2	210.8	880	2199	
TSF-H118	H118-1	12.47	0	0	0	0.00	0.00	112.6	146.2	210.8	880	2199	
TSF-H118	H118-2	12.47	2	0	0	3.12	4.6	3.5	4.6	6.6	1730	4324	
TSF-H119	H119-1	12.47	180	0	0	228.76	334.5	257.6	334.5	482.1	1284	3209	
TSF-H119	H119-2	12.47	0	0	436	0.00	637.6	491.0	637.6	918.9	1526	3816	
TSF-H120	H120-1	12.47	314	0	0	399.99	585.0	450.4	585.0	843.0	2291	5727	
TSF-H121	H121-1	12.47	1106	0	192	1408.25	2059.5	1585.8	2059.5	2967.9	2436	6090	
TSF-H122	H122-1	12.47	206	43	205	261.84	662.8	510.4	662.8	955.2	1100	2751	
TSF-H123	H123-1	12.47	1070	98	24	1362.47	1992.5	1534.3	1992.5	2871.4	1612	4029	
TSF-H124	H124-1	4.16	736	111	36	937.31	1370.8	1055.5	1370.8	1975.4	1667	4168	
TSF-H125	H125-1	4.16	236	6	24	300.49	439.4	338.4	439.4	633.3	239	598	
TSF-H126	H126-1	11.5	688	0	0	876.02	1281.1	886.5	1281.1	1846.2	1668	4170	
TSF-H126	H126-2	11.5	126	71	62	160.68	378.8	291.7	378.8	545.9	978	2445	
TSF-H127	H127-1	11.5	386	66	41	491.70	720.3	554.7	720.3	1038.1	675	1688	
TSF-H127	H127-2	11.5	289	0	0	368.07	538.3	338.4	538.3	775.7	965	2412	
TSF-H128	H128-1	12.47	25	0	0	31.94	46.7	36.0	46.7	67.3	1074	2686	
TSF-H128	H128-2	12.47	332	2	0	422.67	618.1	476.0	618.1	890.8	1541	3853	
TSF-H129	H129-1	12.47	268	0	0	341.61	499.6	384.7	499.6	719.9	1782	4456	
TSF-H130	H130-1	12.47	44	112	72	56.43	334.1	257.3	334.1	481.5	1205	3013	
TSF-H130	H130-2	12.47	253	41	0	322.18	471.2	362.8	471.2	679.0	1155	2887	
TSF-H131	H131-1	12.47	482	144	14	613.85	934.9	719.9	934.9	1347.2	1540	3850	
TSF-H132	H132-1	12.47	1995	48	261	2541.68	3717.1	2862.1	3717.1	5356.6	1530	3825	
TSF-H132	H132-2	12.47	646	21	222	823.27	1300.2	1001.2	1300.2	1873.7	857	2143	
TSF-H133	H133-1	12.47	1819	88	792	2316.99	3947.1	3039.3	3947.1	5688.1	2120	5300	
TSF-H134	H134-1	12.47	1288	56	175	1640.64	2399.4	1847.5	2399.4	3457.7	1163	2907	
TSF-H134	H134-2	12.47	801	110	5	1020.89	1493.0	1149.6	1493.0	2151.5	1536	3841	
TSF-H135	H135-1	12.47	290	250	213	369.50	1101.8	848.4	1101.8	1587.8	1084	2711	
TSF-H135	H135-2	12.47	1560	142	16	1987.03	2905.9	2373.6	2905.9	4187.7	1636	4090	
TSF-H136	H136-1	12.47	340	112	0	433.03	660.7	508.7	660.7	952.1	1559	3897	
TSF-H136	H136-2	12.47	85	10	0	108.48	158.6	122.2	158.6	228.6	1288	3219	
TSF-H137	H137-1	11.5	773	0	167	985.30	1441.0	1109.5	1441.0	2076.5	1343	3358	
TSF-H138	H138-1	12.47	681	48	54	867.29	1268.4	976.6	1268.4	1827.8	734	1834	
TSF-H139	H139-1	12.47	1349	262	30	1717.85	2512.3	1934.4	2512.3	3620.4	2204	5510	
TSF-H140	H140-1	12.47	1166	36	808	1485.19	2938.9	2262.9	2938.9	4235.2	525	1312	
TSF-H140	H140-2	12.47	1067	209	124	1358.75	2047.0	1576.1	2047.0	2949.8	1223	3058	
TSF-H141	H141-1	12.47	1078	125	138	1373.69	2009.0	1546.9	2009.0	2895.1	1094	2734	
TSF-H141	H141-2	12.47	364	6	260	463.08	921.6	709.6	921.6	1328.1	202	506	
TSF-H142	H142-1	12.47	637	253	119	811.52	1475.7	1136.3	1475.7	2126.6	693	1733	
TSF-H142	H142-2	12.47	1432	321	84	1823.87	2686.8	2068.8	2686.8	3871.9	2285	5713	
TSF-H143	H143-1	11.5	849	25	9	1081.47	1581.6	1217.8	1581.6	2279.2	1135	2837	
TSF-H143	H143-2	11.5	489	63	180	622.61	1070.7	824.4	1070.7	1543.0	2034	5084	
TSF-H144	H144-1	12.47	416	122	40	530.54	846.0	651.4	846.0	1219.1	1736	4341	
TSF-H144	H144-2	12.47	86	23	0	108.91	159.3	122.6	159.3	229.5	1184	2959	
TSF-H145	H145-1	12.47	782	135	25	996.42	1457.2	1122.1	1457.2	2100.0	1777	4442	
TSF-H145	H145-2	12.47	270	63	81	344.12	605.9	466.6	605.9	873.2	1343	3358	
TSF-H146	H146-1	12.47	86	169	0	109.49	373.2	287.4	373.2	537.9	1599	3997	
TSF-H146	H146-2	12.47	518	65	32	659.71	964.8	742.9	964.8	1390.3	1054	2656	
TSF-H147	H147-1	12.47	90	0	0	114.90	168.0	129.4	168.0	242.2	1223	3057	
TSF-H147	H147-2	12.47	664	120	144	846.43	1358.2	1045.8	1358.2	1957.2	1287	3218	
TSF-H148	H148-1	12.47	421	60	0	536.48	784.6	604.1	784.6	1130.6	702	1756	
TSF-H148	H148-2	12.47	1351	15	312	1720.80	2516.6	1937.8	2516.6	3626.6	1058	2644	
TSF-H149	H149-1	12.47	1227	275	49	1562.56	2285.2	1759.6	2285.2	3293.1	991	2477	

SUBSTATION	CKT	Primary Voltage (kV)	Existing installed Based on NEM Data (kW)	Approved DG [kW]	In process [kW]	Total DG (kW) on Primary -2014		Total DG kW on Primary -2016		Total DG kW on Primary -2020		Total DG kW on Primary -2030		Existing Primary Min Load (kVA)	Existing Primary Peak Load (kVA)
						Short Term	Mid Term	Short Term	Mid Term	Long Term	Long Term				
TSF-H149	H149-2	12.47	1147	254	42	1461.27	1645.5	2137.0	3079.6	1420	3551				
TSF-H150	H150-1	12.47	888	110	204	1131.66	1354.3	1758.8	2534.6	1556	3891				
TSF-H150	H150-2	12.47	2134	449	668	2718.54	3660.5	4753.9	6850.7	2168	5419				
TSF-H151	H151-1	4.16	171	0	62	218.07	341.1	491.6	143	357					
TSF-H151	H151-2	4.16	426	43	137	542.63	682.1	885.9	1276.6	481	1203				
TSF-H152	H152-1	4.16	330	56	71	420.67	514.2	667.8	962.4	354	884				
TSF-H152	H152-2	4.16	578	92	2	736.65	829.5	1077.3	1552.5	1434	3585				
TSF-H153	H153-1	12.47	1254	26	297	1597.66	1799.1	2336.5	3367.1	1307	3267				
TSF-H153	H153-2	12.47	455	40	148	579.37	723.7	999.8	1354.4	249	622				
TSF-H154	H154-1	11.5	460	0	0	585.97	659.8	857.0	1234.9	2222	5554				
TSF-H155	H155-1	11.5	211	0	32	268.20	302.8	392.2	565.2	1429	3573				
TSF-H155	H155-2	11.5	701	106	0	892.33	1004.8	1305.0	1880.6	1982	4954				
TSF-H156	H156-1	11.5	125	0	98	159.46	251.3	326.4	470.4	1701	4253				
TSF-H156	H156-2	11.5	713	188	33	908.23	1051.4	1365.4	1967.7	1191	2977				
TSF-H157	H157-1	4.16	56	23	74	71.96	172.9	224.6	323.6	212	529				
TSF-H157	H157-2	4.16	51	10	0	64.94	73.1	95.0	136.9	260	651				
TSF-H157	H157-3	4.16	18	0	0	23.55	38.7	50.3	72.5	101	252				
TSF-H158	H158-1	12.47	1237	62	16	1576.37	1775.1	2305.4	3322.2	1445	3613				
TSF-H158	H158-2	12.47	3476	27	747	4428.13	4986.4	6475.9	9332.3	3251	8128				
TSF-H159	H159-1	12.47	413	34	10	526.35	592.7	769.8	1109.3	466	1165				
TSF-H159	H159-2	12.47	3154	10	651	4018.26	4524.9	5876.5	8468.5	2070	5176				
TSF-H160	H160-1	12.47	1918	204	215	2443.59	2751.7	3573.6	5149.9	1901	4753				
TSF-H160	H160-2	12.47	551	2	207	701.42	855.7	1111.3	1601.5	432	1080				
TSF-H161	H161-1	12.47	2065	28	376	2630.70	2962.4	3847.3	5544.2	1618	4046				
TSF-H161	H161-2	12.47	32	0	0	40.38	45.5	59.1	85.1	445	1113				
TSF-H162	H162-1	12.47	474	120	114	603.37	797.4	1035.6	1492.3	1698	4244				
TSF-H162	H162-2	12.47	272	176	6	346.09	511.4	664.2	957.1	1605	4012				
TSF-H163	H163-1	12.47	268	0	0	341.53	384.6	499.5	719.8	1705	4263				
TSF-H164	H164-1	12.47	874	248	22	1113.28	1287.8	1672.4	2410.1	1462	3654				
TSF-H164	H164-2	12.47	1247	161	291	1589.01	1912.8	2484.1	3579.8	2290	5724				
TSF-H165	H165-1	11.5	141	25	188	178.99	398.0	516.8	744.8	800	2000				
TSF-H165	H165-2	11.5	535	28	0	661.99	768.0	997.4	1437.3	1182	2954				
TSF-H166	H166-1	11.5	1479	68	42	1884.16	2121.7	2755.5	3970.9	1745	4363				
TSF-H166	H166-2	11.5	519	44	0	661.75	745.2	967.8	1394.6	1296	3241				
TSF-H167	H167-1	4.16	630	0	199	550.14	710.8	923.2	1330.4	392	981				
TSF-H168	H168-1	4.16	432	9	189	802.26	932.2	1210.7	1744.7	574	1436				
TSF-H169	H169-1	11.5	790	161	30	1006.76	1133.7	1472.3	2121.7	1390	3476				
TSF-H170	H170-1	11.5	208	23	85	265.15	355.1	461.2	664.6	978	2444				
TSF-H170	H170-2	11.5	590	1	256	752.14	1239.6	1786.3	2488.1	1691	4228				
TSF-H171	H171-1	12.47	1597	81	89	2034.68	2291.2	2975.6	4288.1	1691	4228				
TSF-H171	H171-2	12.47	533	0	99	679.46	765.1	993.7	1432.0	1126	2816				
TSF-H172	H172-1	12.47	557	302	27	710.09	998.2	1296.4	1868.2	2882	7205				
TSF-H172	H172-2	12.47	1054	167	36	1343.18	1512.5	1964.3	2830.8	1235	3088				
TSF-H173	H173-1	12.47	1029	170	70	1311.37	1476.7	1917.8	2763.7	1527	3817				
TSF-H173	H173-2	12.47	440	124	19	561.00	657.2	853.5	1229.9	776	1941				
TSF-H174	H174-1	12.47	116	64	98	148.01	313.1	406.6	585.9	484	1209				
TSF-H174	H174-2	12.47	1090	222	71	1388.24	1563.3	2030.2	2925.7	1810	4525				
TSF-H175	H175-1	12.47	34	10	0	43.74	49.9	64.8	93.4	1173	2932				
TSF-H176	H176-1	12.47	24	0	0	30.52	34.4	44.6	64.3	1764	4410				
TSF-H176	H176-2	12.47	21	0	0	27.29	30.7	39.9	57.5	1103	2757				
TSF-H177	H177-1	12.47	46	0	0	58.60	66.0	85.7	123.5	1176	2941				

SUBSTATION	CKT	Existing Sub						Existing Sub				Existing Sub				2016 Short Term			
		Existing DG on Sub XFMR	Existing Sub XFMR Min Load (kVA)	Existing Sub XFMR Peak Load (kVA)	Remaining Sub kW to 100% Gross DML	Existing DG Sub XFMR MVA	Existing 50% Sub XFMR	Remaining DG to 50% Substation XFMR Rating (kW)	Existing DG on Sub XFMR	Existing Sub XFMR Min Load (kVA)	Existing Sub XFMR Peak Load (kVA)	Remaining DG to 100% Gross DML	Existing 50% Sub XFMR	Existing 50% Substation XFMR Rating (kW)	2016 DG on Sub XFMR	2016 Sub XFMR Min Load (kVA)	2016 Sub XFMR Peak Load (kVA)	2016 DML-DG	2016 Short Term Remaining DG to 50% Substation XFMR Rating (kW)
TSF-HI49	H149-2	3024	2411	6028	-613	5	4387	3405	2473	6182	-932	5	4068	3405	2473	6182	-932	4068	
TSF-HI50	H150-1	3850	3724	9310	-126	5	4874	5015	3819	9548	-1196	5	3804	5015	3819	9548	-1196	3804	
TSF-HI51	H151-1	761	624	1560	-137	2	1738	945	640	1600	-305	2	1570	945	640	1600	-305	1570	
TSF-HI52	H152-1	1157	1788	4469	630	2	2505	1344	1833	4583	490	2	2365	1344	1833	4583	490	2365	
TSF-HI53	H153-1	2177	1556	3889	-621	5	4379	2523	1595	3988	-927	5	4073	2523	1595	3988	-927	4073	
TSF-HI54	H154-1	586	2222	5554	1636	5	6636	660	2278	5696	1619	5	6619	660	2278	5696	1619	6619	
TSF-HI55	H155-1	1161	3411	8527	2250	5	7250	1307	3498	8745	2191	5	7191	1307	3498	8745	2191	7191	
TSF-HI56	H156-1	1068	2892	7230	1824	5	6824	1303	2966	7415	1663	5	6663	1303	2966	7415	1663	6663	
TSF-HI57	H157-1	160	573	1432	412	2	2512	285	587	1469	303	2	2403	285	587	1469	303	2403	
TSF-HI58	H158-1	6004	4696	11741	-1308	5	3692	6762	4817	12041	-1945	5	3055	6762	4817	12041	-1945	3055	
TSF-HI59	H159-1	4545	2536	6941	-2008	5	2992	5118	2601	6503	-2516	5	2484	5118	2601	6503	-2516	2484	
TSF-HI60	H160-1	3145	2333	5833	-812	5	4188	3607	2393	5982	-1215	5	3785	3607	2393	5982	-1215	3785	
TSF-HI61	H161-1	2671	2064	5159	-607	5	4393	3008	2116	5391	-891	5	4109	3008	2116	5391	-891	4109	
TSF-HI62	H162-1	949	3302	8256	2353	5	7353	1309	3387	8467	2078	5	7078	1309	3387	8467	2078	7078	
TSF-HI63	H163-1	342	1705	4263	1364	5	6364	385	1749	4372	1364	5	6364	385	1749	4372	1364	6364	
TSF-HI64	H164-1	2702	3751	9378	1049	5	6049	3201	3847	9618	647	5	5647	3201	3847	9618	647	5647	
TSF-HI65	H165-1	861	1982	4954	1121	5	6121	1166	2032	5081	866	5	5866	1166	2032	5081	866	5866	
TSF-HI66	H166-1	2546	3042	7604	496	5	5496	2867	3119	7798	252	5	5252	2867	3119	7798	252	5252	
TSF-HI67	H167-1	550	392	981	-158	2	1717	711	402	1006	-308	2	1567	711	402	1006	-308	1567	
TSF-HI68	H168-1	802	574	1436	-228	2	1647	932	589	1473	-343	2	1532	932	589	1473	-343	1532	
TSF-HI69	H169-1	1007	1390	3476	384	5	5384	1134	1426	3565	292	5	5292	1134	1426	3565	292	5292	
TSF-HI70	H170-1	1017	2384	5961	1367	5	6367	1310	2445	6113	1136	5	6136	1310	2445	6113	1136	6136	
TSF-HI71	H171-1	2714	2818	7044	103	5	5103	3056	2890	7224	-167	5	4833	3056	2890	7224	-167	4833	
TSF-HI72	H172-1	2053	4117	10293	2064	5	7064	2511	4222	10556	1712	5	6712	2511	4222	10556	1712	6712	
TSF-HI73	H173-1	1872	2303	5758	431	5	5431	2134	2362	5905	228	5	5228	2134	2362	5905	228	5228	
TSF-HI74	H174-1	1536	2294	5734	757	5	5757	1876	2352	5881	476	5	5476	1876	2352	5881	476	5476	
TSF-HI75	H175-1	44	1173	2932	1129	6	6629	50	1203	3007	1153	6	6653	50	1203	3007	1153	6653	
TSF-HI76	H176-1	58	2867	7167	2809	5	7809	65	2940	7350	2875	5	7875	65	2940	7350	2875	7875	
TSF-HI77	H177-1	59	1176	2941	1118	5	6118	66	1206	3016	1141	5	6141	66	1206	3016	1141	6141	

SUBSTATION	CKT	2020 DG on Sub XFMR					2020 Sub XFMR					2020 Midterm Remaining DG to 50% Substation XFMR Rating (kW)					2030 Long Term Remaining DG to 50% Substation XFMR Rating (kW)				
		Min Load (kVA)	2020 Sub XFMR Min Load (kVA)	2020 Sub XFMR Peak Load (kVA)	2020 Sub XFMR	2020 Sub XFMR	2020 DML-DG	2020 DML-DG	2020 DML-DG	2020 DML-DG	2020 DML-DG	2030 DG on Sub XFMR	2030 Sub XFMR Min Load (kVA)	2030 Sub XFMR Peak Load (kVA)	2030 DML-DG	2030 DML-DG	2030 DML-DG	2030 DML-DG	2030 DML-DG	2030 DML-DG	2030 DML-DG
TSF-H149	H149-2	4422	2545	6362	6362	-1877	3123	3123	4456	544											
TSF-H150	H150-1	6513	3930	9826	9826	-2582	2418	2418	-6425	-1425											
TSF-H151	H151-1	1227	659	1646	1646	-568	1307	1307	-1272	603											
TSF-H152	H152-1	1745	1887	4717	4717	141	2016	2016	-1094	781											
TSF-H153	H153-1	3276	1642	4105	4105	-1635	3365	3365	-3485	1515											
TSF-H154	H154-1	857	2345	5862	5862	1488	6488	6488	531	5531											
TSF-H155	H155-1	1697	3600	9000	9000	1903	6903	6903	265	5265											
TSF-H156	H156-1	1692	3052	7631	7631	1360	6360	6360	-139	4861											
TSF-H157	H157-1	370	605	1511	1511	235	2335	2335	-78	2022											
TSF-H158	H158-1	8781	4957	12392	12392	-3825	1175	1175	-8921	-3921											
TSF-H159	H159-1	6646	2677	6692	6692	-3969	1031	1031	-7562	-2562											
TSF-H160	H160-1	4685	2462	6156	6156	-2222	2778	2778	-4897	103											
TSF-H161	H161-1	3906	2178	5445	5445	-1728	3272	3272	-3989	1011											
TSF-H162	H162-1	1700	3485	8713	8713	1786	6786	6786	176	5176											
TSF-H163	H163-1	499	1800	4499	4499	1300	6300	6300	636	5636											
TSF-H164	H164-1	4157	3959	9898	9898	-197	4803	4803	-3008	1992											
TSF-H165	H165-1	1514	2091	5229	5229	577	5577	5577	-607	4393											
TSF-H166	H166-1	3723	3210	8025	8025	-513	4487	4487	-2948	2052											
TSF-H167	H167-1	923	414	1035	1035	-509	1366	1366	-1018	857											
TSF-H168	H168-1	1211	606	1516	1516	-604	1271	1271	-1288	587											
TSF-H169	H169-1	1472	1467	3669	3669	-5	4995	4995	-1017	3983											
TSF-H170	H170-1	1701	2517	6291	6291	816	5816	5816	-556	4444											
TSF-H171	H171-1	3969	2974	7434	7434	-996	4004	4004	-3480	1520											
TSF-H172	H172-1	3261	4345	10863	10863	1085	6085	6085	-1426	3574											
TSF-H173	H173-1	2771	2431	6077	6077	-340	4660	4660	-2163	2837											
TSF-H174	H174-1	2437	2421	6052	6052	-16	4984	4984	-1688	3312											
TSF-H175	H175-1	65	1238	3094	3094	1173	6673	6673	839	6339											
TSF-H176	H176-1	85	3026	7564	7564	2941	7941	7941	2157	7157											
TSF-H177	H177-1	86	1242	3104	3104	1156	6156	6156	812	5812											

SUBSTATION	CKT	Primary Voltage (kV)	Existing installed Based on NEM Data (kW)	Approved DG [kW]	In process [kW]	Total DG (kW) on Primary -2014		Total DG kW on Primary -2016		Total DG kW on Primary -2020		Total DG kW on Primary -2030		Existing Primary Peak Load (kVA)		
						Short Term	Mid Term	Long Term	Short Term	Mid Term	Long Term	Short Term	Mid Term	Long Term	Primary Min Load (kVA)	Primary Peak Load (kVA)
TSF-H178	H178-1	12.47	494			74	38	628.92	708.2	919.8	1325.4	1093	2732			
TSF-H178	H178-2	12.47	2293			144	443	2921.32	3289.7	4272.3	6156.7	2038	5095			
TSF-H179	H179-1	11.5	600			30	0	763.94	860.3	1117.2	1610.0	1527	3968			
TSF-H179	H179-2	11.5	1041			93	4	1325.46	1492.6	1938.4	2793.4	1627	4067			
TSF-H180	H180-1	11.5	2342			115	636	2983.59	3483.1	4523.5	6518.7	1698	4246			
TSF-H180	H180-2	11.5	899			0	0	1145.46	1289.9	1675.2	2414.1	1452	3632			
TSF-H181	H181-1	12.47	313			122	0	398.34	489.2	635.3	915.5	1346	3364			
TSF-H182	H182-1	12.47	1578			417	69	2010.68	2325.6	3020.3	4352.4	2350	5874			
TSF-H183	H183-1	11.5	752			16	174	957.33	1078.0	1400.1	2017.6	508	1270			
TSF-H183	H183-2	11.5	1703			140	290	2169.44	2443.0	3172.7	4572.1	1724	4309			
TSF-H184	H184-1	11.5	799			7	313	1017.38	1259.9	1636.2	2357.9	684	1710			
TSF-H184	H184-2	11.5	764			154	0	973.69	1096.5	1424.0	2052.1	1345	3362			
TSF-H185	H185-1	11.5	1509			34	416	1922.22	2206.0	2864.9	4128.5	1079	2697			
TSF-H185	H185-2	11.5	934			167	5	1189.82	1339.8	1740.1	2507.6	1574	3934			
TSF-H186	H186-1	12.47	165			37	99	210.21	338.4	439.5	633.4	839	2097			
TSF-H186	H186-2	12.47	524			88	296	667.67	1023.1	1328.8	1914.9	1219	3048			
TSF-H187	H187-1	12.47	597			272	33	760.91	1015.4	1318.7	1900.3	1261	3153			
TSF-H187	H187-2	12.47	1859			138	305	2367.57	2666.1	3462.5	4989.7	2084	5210			
TSF-H188	H188-1	12.47	1451			147	32	1848.20	2081.2	2702.9	3895.1	1619	4047			
TSF-H188	H188-2	12.47	509			74	102	647.83	770.7	1000.9	1442.4	1285	3212			
TSF-H189	H189-1	12.47	607			19	0	773.53	871.1	1131.3	1630.2	1111	2778			
TSF-H190	H190-1	12.47	375			115	114	478.25	680.0	883.1	1272.7	1111	2778			
TSF-H191	H191-1	12.47	40			0	0	294.87	431.2	621.4	821.4	411	1028			
TSF-H192	H192-1	12.47	682			66	5	868.50	978.0	1270.1	1830.4	1391	3478			
TSF-H192	H192-2	12.47	601			108	0	765.71	862.3	1119.8	1613.7	1166	2915			
TSF-H193	H193-1	12.47	847			13	219	1079.22	1215.3	1578.3	2274.5	622	1556			
TSF-H193	H193-2	12.47	970			12	265	1236.25	1404.6	1824.2	2628.8	622	1556			
TSF-H194	H194-1	4.16	80			0	4	101.31	114.1	148.2	213.5	45	113			
TSF-H194	H194-2	4.16	574			24	145	730.60	836.4	1086.3	1565.4	606	1515			
TSF-H195	H195-1	4.16	519			5	157	660.55	766.6	995.6	1434.8	386	965			
TSF-H195	H195-2	4.16	448			25	66	571.05	643.1	835.1	1203.5	502	1254			
TSF-H196	H196-1	4.16	489			7	164	622.29	743.4	965.5	1391.4	448	1121			
TSF-H197	H197-1	4.16	355			0	182	451.87	605.0	785.7	1132.2	360	899			
Maui Electric																
TSF-M1	M1-1	12.47	753			177	26	958.87	1086.5	1305.2	1564.4	1338	2570			
TSF-M1	M1-2	12.47	266			143	9	311.50	473.2	568.5	813.2	418	823			
TSF-M2	M2-1	2.4	53			47	0	61.90	113.6	136.5	163.6	384	839			
TSF-M2	M2-2	2.4	7			8	0	8.19	17.3	20.8	25.0	201	459			
TSF-M2	M2-3	2.4	27			3	0	31.81	36.0	43.3	51.9	172	458			
TSF-M3	M3-1	2.4	79			50	0	92.69	146.2	175.6	210.5	116	51			
TSF-M4	M4-1	12.47	151			762	0	177.08	1035.1	1243.4	1490.3	1700	4124			
TSF-M4	M4-2	12.47	795			889	16	929.63	1925.5	2313.1	2772.4	1772	3709			
TSF-M4	M4-3	4.16	354			129	42	414.57	594.7	714.4	856.3	409	1134			
TSF-M4	M4-4	4.16	242			71	6	282.57	360.5	433.1	519.1	358	998			
TSF-M4	M4-5	4.16	134			32	4	156.29	192.7	231.5	277.5	247	697			
TSF-M5	M5-1	2.4	3			0	0	3.52	4.0	4.8	5.7	50	48			
TSF-M6	M6-1	2.4	66			0	0	77.21	87.5	105.1	126.0	387	487			
TSF-M7	M7-1	12.47	379			2018	0	443.39	2175.7	3262.4	3910.1	1714	3529			
TSF-M7	M7-2	12.47	157			666	0	183.92	932.8	1120.6	1343.0	473	1402			
TSF-M7	M7-3	12.47	787			310	0	920.80	1243.5	1493.8	1790.4	1703	3475			
TSF-M7	M7-4	12.47	1216			165	0	1422.45	1611.8	1936.3	2320.7	2004	4120			

SUBSTATION	CKT	Primary Voltage (kV)	Existing installed Based on NEM Data (kW)	Approved DG [kW]	In process [kW]	Total DG (kW) on Primary -2014		Total DG kW on Primary -2016		Total DG kW on Primary -2020		Total DG kW on Primary -2030		Existing Primary Min Load (kVA)		Existing Primary Peak Load (kVA)	
						Total DG (kW) on Primary -2014		Total DG kW on Primary -2016		Total DG kW on Primary -2020		Total DG kW on Primary -2030		Existing Primary Min Load (kVA)		Existing Primary Peak Load (kVA)	
						Short Term	Mid Term	Short Term	Mid Term	Short Term	Mid Term	Short Term	Mid Term	Long Term	Long Term	Long Term	Long Term
TSF-M7	M7-5	12.47	719	436	0	841.07	1308.6	1572.0	1884.1	1884.1	2197	3388					
TSF-M7	M7-6	12.47	2127	1317	48	2488.64	3957.5	4754.1	5698.1	5698.1	3510	5143					
TSF-M8	M8-1	12.47	212	180	10	247.62	454.5	546.0	654.5	654.5	319	671					
TSF-M9	M9-1	2.4	4	50	0	4.53	61.1	73.4	87.9	87.9	39	184					
TSF-M10	M10-1	12.47	592	334	20	692.39	1071.5	1287.2	1542.8	1542.8	2020	3084					
TSF-M10	M10-2	12.47	1090	337	5	1275.21	1622.8	1949.5	2336.6	2336.6	2311	3676					
TSF-M10	M10-3	12.47	432	111	0	505.59	615.5	739.4	886.2	886.2	1467	2216					
TSF-M10	M10-4	12.47	2234	890	51	2613.28	3596.9	4321.0	5178.9	5178.9	4048	5937					
TSF-M10	M10-5	12.47	1519	476	29	1776.80	2292.9	2754.4	3301.3	3301.3	2094	4184					
TSF-M10	M10-6	12.47	1720	724	122	2012.30	2907.0	3492.1	4185.5	4185.5	1760	2693					
TSF-M11	M11-1	4.16	198	72	0	231.54	305.8	367.4	440.3	440.3	473	894					
TSF-M12	M12-1	12.47	1237	412	34	1447.70	1907.7	2291.8	2746.8	2746.8	2064	4098					
TSF-M12	M12-2	12.47	1196	516	19	1398.97	1961.1	2355.9	2823.7	2823.7	1553	4384					
TSF-M13	M13-1	12.47	109	210	0	126.99	360.5	433.1	519.1	519.1	44	14					
TSF-M14	M14-1	12.47	397	192	15	464.18	683.6	821.2	984.3	984.3	2559	4519					
TSF-M14	M14-2	12.47	638	584	31	745.84	1419.2	1704.9	2043.4	2043.4	904	2005					
TSF-M14	M14-3	12.47	189	213	0	221.04	455.2	546.8	655.4	655.4	848	1598					
TSF-M14	M14-4	12.47	21	46	4	24.13	79.6	95.6	114.6	114.6	665	1378					
TSF-M14	M14-5	12.47	976	506	21	1142.06	1703.4	2046.3	2452.6	2452.6	2191	4158					
TSF-M14	M14-6	12.47	56	20	0	65.50	86.0	103.3	123.8	123.8	916	2186					
TSF-M14	M14-7	12.47	887	797	26	1037.18	1937.7	2327.8	2790.0	2790.0	2482	4297					
TSF-M15	M15-1	12.47	1375	746	8	1608.50	2412.1	2897.6	3473.0	3473.0	2494	4976					
TSF-M15	M15-2	12.47	311	132	0	363.61	502.1	603.2	722.9	722.9	990	2071					
TSF-M16	M16-1	12.47	1164	277	17	1362.02	1651.8	1984.3	2378.3	2378.3	5175	9167					
TSF-M16	M16-2	12.47	570	1719	8	667.08	2604.0	3128.1	3749.3	3749.3	2251	4002					
TSF-M16	M16-3	12.47	19	0	0	22.60	25.6	30.8	36.9	36.9	306	1073					
TSF-M17	M17-1	12.47	410	310	18	479.53	835.7	1003.9	1203.3	1203.3	558	2045					
TSF-M17	M17-2	12.47	462	406	11	540.36	995.4	1195.7	1433.2	1433.2	772	1573					
TSF-M17	M17-3	12.47	432	146	0	505.13	655.2	787.1	943.4	943.4	662	3365					
TSF-M18	M18-1	2.4	170	500	0	198.46	758.8	911.5	1092.5	1092.5	0	0					
TSF-M19	M19-1	12.47	0	0	0	0.00	0.0	0.0	0.0	0.0	130	130					
TSF-M20	M20-1	12.47	269	20	0	314.42	356.3	428.0	513.0	513.0	1949	3340					
TSF-M20	M20-2	12.47	634	1586	6	741.83	2522.1	3029.8	3631.4	3631.4	1528	12311					
TSF-M20	M20-3	12.47	252	137	15	294.79	457.9	550.1	659.4	659.4	1578	3076					
TSF-M21	M21-1	69	0	0	0	0.00	0.0	0.0	0.0	0.0	0	0					
TSF-M22	M22-1	4.16	13	104	0	14.97	132.5	159.2	190.8	190.8	608	1314					
TSF-M22	M22-2	4.16	168	36	0	196.54	231.3	277.8	333.0	333.0	202	538					
TSF-M23	M23-1	4.16	385	506	24	450.45	1036.9	1245.6	1492.9	1492.9	891	1717					
TSF-M24	M24-1	12.47	717	269	9	838.85	1126.9	1353.7	1622.5	1622.5	732	1191					
TSF-M25	M25-1	12.47	1365	216	12	1596.84	1809.4	2173.6	2605.2	2605.2	1737	4272					
TSF-M25	M25-2	12.47	3	240	0	3.16	275.0	330.4	396.0	396.0	123	1004					
TSF-M25	M25-3	12.47	1544	424	58	1806.39	2295.5	2757.6	3305.2	3305.2	2093	4717					
TSF-M25	M25-4	12.47	150	3	0	175.51	238.9	286.3	350.1	350.1	281	1059					
TSF-M26	M26-1	12.47	1149	230	15	1344.22	1578.7	1896.5	2273.1	2273.1	2751	4909					
TSF-M26	M26-2	12.47	103	10	0	120.09	136.1	163.5	195.9	195.9	2759	5042					
TSF-M26	M26-3	12.47	578	745	0	676.04	1498.8	1800.5	2158.0	2158.0	1872	3051					
TSF-M26	M26-4	12.47	6	262	0	6.46	303.1	364.1	436.5	436.5	61	911					
TSF-M27	M27-1	12.47	334	260	23	391.06	699.6	840.5	1007.4	1007.4	374	748					
TSF-M28	M28-1	12.47	595	708	12	696.54	1490.6	1790.7	2146.2	2146.2	1170	2291					
TSF-M28	M28-2	12.47	1073	575	30	1255.01	1901.8	2284.6	2738.2	2738.2	991	2852					
TSF-M29	M29-1	12.47	435	222	0	508.59	744.7	894.6	1072.2	1072.2	1081	4083					

SUBSTATION	CKT	Primary Voltage (kV)	Existing installed Based on NEM Data (kW)	Approved DG [kW]	In process [kW]	Total DG (kW) on Primary -2014		Total DG kW on Primary -2016		Total DG kW on Primary -2020		Total DG kW on Primary -2030		Existing Primary Min Load (kVA)	Existing Primary Peak Load (kVA)
						Short Term	Mid Term	Short Term	Long Term	Short Term	Long Term	Short Term	Long Term		
TSF-M29	M29-2	12.47	143	9	0	166.92	189.1	227.2	272.3	272.3	315	1094			
TSF-M29	M29-3	12.47	2042	942	161	2388.85	3563.8	4281.2	5131.2	5131.2	2345	3351			
TSF-M29	M29-4	12.47	416	49	0	487.03	551.9	662.9	794.6	794.6	1806	2626			
TSF-M29	M29-5	12.47	122	14	0	143.11	162.2	194.8	233.5	233.5	88	2400			
TSF-M30	M30-1	12.47	0	0	0	0.00	0.0	0.0	0.0	0.0	0	0			
TSF-M31	M31-1	12.47	714	261	15	835.46	1121.7	1347.5	1615.1	1615.1	1815	3537			
TSF-M31	M31-2	12.47	218	171	0	255.26	441.2	530.0	635.2	635.2	891	1966			
TSF-M31	M31-3	12.47	565	210	10	660.57	889.3	1068.3	1280.4	1280.4	2304	4821			
TSF-M31	M31-4	12.47	0	250	0	0.00	283.3	340.3	407.9	407.9	1401	2405			
TSF-M31	M31-5	12.47	124	50	22	145.41	221.6	266.1	319.0	319.0	1520	2780			
TSF-M31	M31-6	12.47	150	0	0	175.49	198.8	238.9	286.3	286.3	1231	2308			
TSF-M31	M31-7	12.47	941	390	17	1101.36	1527.8	1835.3	2199.8	2199.8	1142	1771			
TSF-M31	M31-8	12.47	409	15	0	478.12	541.8	650.8	780.1	780.1	2804	4473			
TSF-M32	M32-1	12.47	500	1351	19	584.66	2118.7	2545.2	3050.6	3050.6	880	2069			
TSF-M32	M32-2	12.47	0	0	0	0.00	0.0	0.0	0.0	0.0	259	3601			
TSF-M32	M32-3	12.47	1247	338	4	1459.39	1800.8	2163.2	2592.8	2592.8	2493	4280			
TSF-M32	M32-4	4.16	235	227	200	274.99	749.4	900.3	1079.0	1079.0	620	839			
TSF-M32	M32-5	4.16	233	218	21	272.26	535.1	642.8	770.4	770.4	385	953			
TSF-M33	M33-1	4.16	306	55	11	358.51	422.4	507.4	608.1	608.1	712	1339			
TSF-M33	M33-2	4.16	249	25	34	291.32	348.6	418.8	501.9	501.9	601	1155			
TSF-M34	M34-1	2.4	41	16	0	48.28	64.4	77.4	92.8	92.8	87	62			
TSF-M35	M35-1	12.47	0	0	0	0.00	0.0	0.0	0.0	0.0	869	6876			
TSF-M35	M35-2	12.47	130	0	0	152.09	172.3	207.0	248.1	248.1	261	666			
TSF-M35	M35-3	12.47	191	0	0	223.45	253.2	304.2	364.6	364.6	298	2168			
TSF-M35	M35-4	12.47	720	0	0	842.33	954.5	1146.6	1374.3	1374.3	751	1301			
TSF-M35	M35-5	12.47	188	0	0	219.94	249.2	299.4	358.8	358.8	168	817			
TSF-M36	M36-1	12.47	117	21	0	137.20	156.9	188.4	225.8	225.8	917	2092			
TSF-M36	M36-2	12.47	21	4	0	24.07	27.8	33.5	40.1	40.1	198	385			
TSF-M36	M36-3	12.47	10	10	0	11.18	22.2	26.6	31.9	31.9	357	956			
TSF-M37	M37-1	12.47	120	92	0	140.51	240.6	289.0	346.4	346.4					
TSF-M37	M37-2	12.47	838	128	80	980.38	1185.2	1423.8	1706.5	1706.5					
TSF-M37	M37-3	12.47	210	95	0	245.89	345.8	415.5	498.0	498.0	3902	22635			
Hawaii Electric Light															
TSF-L1	L1-1	12.47	624	73	0	643.30	792.8	958.4	1148.7	1148.7	1797	3060			
TSF-L1	L1-2	12.47	83	58	0	85.12	160.4	193.9	232.4	232.4	407	1090			
TSF-L2	L2-1	12.47	168	4	0	172.76	196.4	237.5	284.6	284.6	1006	2624			
TSF-L2	L2-2	12.47	19	47	0	19.76	75.5	91.3	109.4	109.4	956	2270			
TSF-L3	L3-1	12.47	475	53	0	489.17	595.5	724.8	868.7	868.7	906	3900			
TSF-L4	L4-1	2.4	137	11	0	141.43	168.6	203.8	244.3	244.3	198	397			
TSF-L5	L5-1	2.4	143	31	0	146.83	197.4	238.6	286.0	286.0	532	883			
TSF-L6	L6-1	12.47	0	100	0	0.00	113.7	137.4	164.7	164.7	1184	1676			
TSF-L7	L7-1	12.47	49	170	0	174.87	249.1	301.2	361.0	361.0	612	800			
TSF-L8	L8-1	4.16	304	68	0	312.90	422.5	510.8	612.2	612.2	502	867			
TSF-L8	L8-2	4.16	129	18	0	132.98	167.2	202.1	242.2	242.2	488	629			
TSF-L9	L9-1	12.47	241	85	0	248.15	370.7	448.1	537.1	537.1	866	1690			
TSF-L9	L9-2	12.47	275	38	0	283.84	356.8	431.3	516.9	516.9	519	1550			
TSF-L10	L10-1	12.47	67	0	2.4	68.99	94.8	113.7	137.4	137.4	163	301			
TSF-L11	L11-1	12.47	691	530	0	711.95	1388.2	1678.2	2011.5	2011.5	880	2620			
TSF-L11	L11-2	12.47	33	47	0	33.49	90.0	108.8	130.4	130.4	459	590			
TSF-L12	L12-1	12.47	939	196	0	967.36	1290.8	1560.5	1870.3	1870.3	1490	3710			

SUBSTATION	CKT	Primary Voltage (kV)	Existing installed Based on NEM Data (kW)	Approved DG [kW]	In process [kW]	Total DG (kW) on Primary-2014		Total DG kW on Primary-2016		Total DGkW on Primary-2020		Total DG kW on Primary-2030		Existing Primary Min Load (kVA)	Existing Primary Peak Load (kVA)
						Primary-2014	Short Term	Primary-2016	Mid Term	Primary-2020	Long Term	Primary-2030	Long Term		
TSF-L12	L12-2	12.47	529	103	0	545.51	718.7	868.8	1041.3	892	1880				
TSF-L13	L13-1	12.47	2008	264	0	2068.81	3123.0	3123.0	3743.1	2598	5860				
TSF-L14	L14-1	12.47	969	123	0	998.89	1242.1	1501.6	1799.8	942	2500				
TSF-L14	L14-2	12.47	894	8	0	921.57	1041.8	1266.7	1518.2	1866	2410				
TSF-L14	L14-3	12.47	75	18	0	77.62	105.6	127.6	152.9	237	940				
TSF-L14	L14-4	12.47	1125	126	0	1159.11	1422.2	1719.3	2067.7	1304	2930				
TSF-L15	L15-1	12.47	671	445	0	691.49	1269.4	1534.6	1839.3	3137	3700				
TSF-L15	L15-2	12.47	223	0	0	229.76	261.2	315.8	378.5	490	4888				
TSF-L15	L15-3	12.47	1773	80	0	1826.75	2106.3	2546.3	3051.9	3329	6250				
TSF-L16	L16-1	12.47	725	176	0	747.06	1024.0	1237.9	1483.7	968	2670				
TSF-L16	L16-2	12.47	144	6	0	148.15	170.3	205.9	246.8	71	210				
TSF-L16	L16-3	12.47	646	0	0	665.75	756.9	915.1	1096.7	567	1400				
TSF-L16	L16-4	12.47	65	0	0	67.16	76.4	92.3	110.6	73	180				
TSF-L17	L17-1	12.47	55	0	0	57.14	65.0	78.5	94.1	472	1036				
TSF-L17	L17-2	12.47	476	136	0	490.85	696.2	841.7	1008.8	826	1408				
TSF-L18	L18-1	13.8	322	124	0	331.50	506.5	612.3	733.9	701	1562				
TSF-L18	L18-2	13.8	205	300	0	210.73	573.6	693.5	831.1	1359	2959				
TSF-L18	L18-3	13.8	303	20	0	311.75	367.1	443.8	531.9	618	1240				
TSF-L18	L18-4	13.8	95	0	0	97.88	111.3	134.5	161.2	266	922				
TSF-L18	L18-5	13.8	489	0	0	503.56	572.5	692.1	829.6	678	1435				
TSF-L19	L19-1	13.8	3	16	0	2.99	21.5	26.0	31.1	577	899				
TSF-L19	L19-2	13.8	405	183	0	417.53	668.9	808.7	969.3	1254	2705				
TSF-L20	L20-1	12.47	392	157	0	403.75	623.6	753.9	903.6	1010	1416				
TSF-L20	L20-2	12.47	654	0	0	674.16	766.5	926.6	1110.6	1632	3268				
TSF-L20	L20-3	12.47	174	23	0	178.96	223.9	270.6	324.4	1578	3348				
TSF-L21	L21-1	12.47	126	26	0	129.41	172.6	208.6	250.1	203	400				
TSF-L21	L21-2	12.47	73	7	0	75.31	91.4	110.5	132.4	212	1160				
TSF-L21	L21-3	12.47	333	44	0	342.86	428.2	517.7	620.5	388	1320				
TSF-L22	L22-1	12.47	1026	0	0	1057.26	1202.1	1453.2	1741.7	42	120				
TSF-L22	L22-2	12.47	154	6796	0	158.47	7901.4	9552.0	11448.7	942	1950				
TSF-L23	L23-1	12.47	605	100	0	623.64	801.6	969.0	1161.4	1037	2004				
TSF-L24	L24-1	12.47	902	79	0	929.26	1115.5	1348.5	1616.3	1192	3130				
TSF-L24	L24-2	12.47	298	18	0	306.60	358.9	433.9	520.1	320	1300				
TSF-L25	L25-1	12.47	48	13	0	49.87	69.2	83.7	100.3	67	220				
TSF-L25	L25-2	12.47	335	0	0	345.62	393.0	475.0	569.4	274	800				
TSF-L26	L26-1	12.47	970	63	0	999.27	1174.1	1419.3	1701.2	891	3070				
TSF-L26	L26-2	12.47	888	117	0	915.05	1142.3	1381.0	1655.2	702	2450				
TSF-L27	L27-1	12.47	56	700	0	57.70	859.1	1038.5	1244.8	577	714				
TSF-L27	L27-2	12.47	95	0	0	97.88	111.3	134.5	161.2	172	278				
TSF-L27	L27-3	12.47	423	11	0	436.25	496.0	599.6	718.7	362	1014				
TSF-L28	L28-1	12.47	86	9	0	88.71	108.6	131.3	157.4	128	983				
TSF-L28	L28-2	12.47	258	71	0	265.32	373.7	451.8	541.5	590	1648				
TSF-L29	L29-1	12.47	490	127	0	504.84	701.7	848.3	1016.8	495	940				
TSF-L30	L30-1	12.47	174	1272	0	179.57	1644.4	1988.0	2382.7	366	840				
TSF-L30	L30-2	12.47	174	40	0	179.16	243.3	294.1	352.5	514	1410				
TSF-L31	L31-1	12.47	431	58	0	443.92	555.9	672.0	805.5	613	1270				
TSF-L31	L31-2	12.47	181	20	0	185.99	227.8	275.3	330.0	896	1650				
TSF-L32	L32-1	12.47	1658	142	0	1708.64	2046.3	2473.8	2965.1	1921	5090				
TSF-L32	L32-2	12.47	1967	459	0	2036.29	2758.2	3334.4	3996.5	2666	3670				
TSF-L32	L32-3	12.47	88	21	0	90.93	124.3	150.3	180.2	139	250				
TSF-L33	L33-1	12.47	978	485	0	1007.14	1662.6	2009.9	2409.0	2853	5860				

SUBSTATION	CKT	Existing Sub XWFR						Existing Sub Remaining DG to 50% Substation				2016 Short Term Remaining DG to 50% Substation						
		Existing DG on Sub XFMR	Existing Sub XFMR Min Load (kVA)	Existing Sub XFMR Peak Load (kVA)	Remaining DG kW to 100% Gross DML	Existing 50% Sub XFMR MVA	Existing 50% Sub XFMR Rating (kW)	2016 DG on Sub XFMR	2016 Sub XFMR Min Load (kVA)	2016 Sub XFMR Peak Load (kVA)	2016 DML-DG	2016 DG on Sub XFMR	2016 Sub XFMR Min Load (kVA)	2016 Sub XFMR Peak Load (kVA)	2016 DML-DG	2016 DG on Sub XFMR		
TSF-L12	L12-2	1513	2382	5590	865.95	3.75	4619	2009	2359	5537	350	2009	2359	5537	350	2009	2359	5537
TSF-L13	L13-1	2069	2598	5860	529.31	5.00	5529	2583	2574	5805	-10	2583	2574	5805	-10	2583	2574	5805
TSF-L14	L14-1																	
TSF-L14	L14-2	1920	2809	4910	888.41	3.33	4218	2290	2782	4864	492	2290	2782	4864	492	2290	2782	4864
TSF-L14	L14-3																	
TSF-L14	L14-4																	
TSF-L15	L15-1	1237	1541	3870	304.09	3.33	3634	1528	1526	3833	-2	1528	1526	3833	-2	1528	1526	3833
TSF-L15	L15-2	921	3627	8588	2705.81	3.33	6036	1531	3593	8507	2062	1531	3593	8507	2062	1531	3593	8507
TSF-L15	L15-3	1827	3329	6250	1502.72	5.00	6503	2106	3298	6191	1192	2106	3298	6191	1192	2106	3298	6191
TSF-L16	L16-1	895	1039	2880	143.76	2.50	2644	1194	1029	2853	-165	1194	1029	2853	-165	1194	1029	2853
TSF-L16	L16-2																	
TSF-L16	L16-3																	
TSF-L16	L16-4	733	639	1580	-93.50	5.00	4906	833	633	1565	-200	833	633	1565	-200	833	633	1565
TSF-L17	L17-1																	
TSF-L17	L17-2	548	1298	2444	749.97	5.00	5750	761	1286	2421	524	761	1286	2421	524	761	1286	2421
TSF-L18	L18-1																	
TSF-L18	L18-2																	
TSF-L18	L18-3																	
TSF-L18	L18-4																	
TSF-L18	L18-5																	
TSF-L19	L19-1																	
TSF-L19	L19-2	1876	5455	11722	3578.95	23.75	27329	2821	5403	11611	2582	2821	5403	11611	2582	2821	5403	11611
TSF-L20	L20-1																	
TSF-L20	L20-2	1078	2642	2642	1564.09	5.00	6564	1390	2617	2617	1227	1390	2617	2617	1227	1390	2617	2617
TSF-L20	L20-3	179	1578	1578	1399.04	5.00	6399	224	1563	1563	1339	224	1563	1563	1339	224	1563	1563
TSF-L21	L21-1																	
TSF-L21	L21-2	548	803	2880	255.48	2.50	2755	692	795	2853	103	692	795	2853	103	692	795	2853
TSF-L21	L21-3																	
TSF-L22	L22-1																	
TSF-L22	L22-2	1216	984	2070	-231.41	2.50	2269	9103	975	2050	-5628	9103	975	2050	-5628	9103	975	2050
TSF-L23	L23-1	624	1037	2004	413.69	5.00	5414	802	1028	1985	226	802	1028	1985	226	802	1028	1985
TSF-L24	L24-1																	
TSF-L24	L24-2	1236	1512	4430	276.32	5.00	5276	1474	1498	4388	23	1474	1498	4388	23	1474	1498	4388
TSF-L25	L25-1																	
TSF-L25	L25-2	395	340	1020	-55.24	0.83	775	462	337	1010	-125	462	337	1010	-125	462	337	1010
TSF-L26	L26-1																	
TSF-L26	L26-2	1914	1593	5520	-321.24	5.00	4679	2316	1578	5468	-738	2316	1578	5468	-738	2316	1578	5468
TSF-L27	L27-1																	
TSF-L27	L27-2	592	1110	2006	518.23	1.33	1848	1466	1100	1987	-367	1466	1100	1987	-367	1466	1100	1987
TSF-L28	L28-1																	
TSF-L28	L28-2	354	718	2631	363.98	5.00	5364	482	711	2606	229	482	711	2606	229	482	711	2606
TSF-L29	L29-1	505	495	940	-10.30	5.00	4990	702	490	931	-212	702	490	931	-212	702	490	931
TSF-L30	L30-1																	
TSF-L30	L30-2	359	880	2250	520.82	2.50	3021	1888	871	2229	-1016	1888	871	2229	-1016	1888	871	2229
TSF-L31	L31-1																	
TSF-L31	L31-2	630	1509	2920	878.94	1.33	2209	784	1495	2892	711	784	1495	2892	711	784	1495	2892
TSF-L32	L32-1	1709	1921	5090	212.68	5.00	5213	2046	1903	5042	-143	2046	1903	5042	-143	2046	1903	5042
TSF-L32	L32-2																	
TSF-L32	L32-3	2117	2805	3920	688.00	5.00	5688	2883	2779	3883	-104	2883	2779	3883	-104	2883	2779	3883
TSF-L33	L33-1	1007	2853	5860	1846.24	5.00	6846	1663	2826	5805	1164	1663	2826	5805	1164	1663	2826	5805

SUBSTATION	CKT	2020 DG on				2020 Sub XFMR				2020 Sub XFMR				2020 Midterm Remaining DG to 50% Substation XFMR Rating (kW)				2030 Long Term Remaining DG to 50% Substation XFMR Rating (kW)			
		Sub XFMR	Min Load (kVA)	2020 Sub XFMR Min Load (kVA)	2020 Sub XFMR Peak Load (kVA)	2020 Sub XFMR Min Load (kVA)	2020 Sub XFMR Peak Load (kVA)	2020 Sub XFMR Min Load (kVA)	2020 Sub XFMR Peak Load (kVA)	2030 DG on Sub XFMR	2030 Sub XFMR Min Load (kVA)	2030 Sub XFMR Peak Load (kVA)	2030 DML-DG	2030 DML-DG	2030 DML-DG	2030 DML-DG	2030 DML-DG	2030 DML-DG	2030 DML-DG	2030 DML-DG	
TSF-L12	L12-2	2429	2429	5702	5702	3750	0	473	4527	3750	5646	-506	3244								
TSF-L13	L13-1	3123	2650	5977	5977	4527	-473	4527	3881	3743	2624	-1119	3881								
TSF-L14	L14-1																				
TSF-L14	L14-2	2768	2865	5008	5008	3427	97	3427	2849	3318	2837	-481	2849								
TSF-L14	L14-3																				
TSF-L14	L14-4	1847	1572	3947	3947	3055	-275	3055	2672	2214	1556	-658	2672								
TSF-L15	L15-1																				
TSF-L15	L15-2	1850	3699	8759	8759	5179	1849	1849	4775	2218	3663	1445	4775								
TSF-L15	L15-3	2546	3396	6375	6375	5850	850	850	5311	3052	3363	311	5311								
TSF-L16	L16-1	1444	1060	2937	2937	2116	-384	2116	1819	1730	1049	-681	1819								
TSF-L16	L16-2																				
TSF-L16	L16-3	1007	652	1612	1612	4645	-355	4645	4438	1207	646	-562	4438								
TSF-L16	L16-4																				
TSF-L17	L17-1	920	1324	2493	2493	5404	404	5404	5208	1103	1311	208	5208								
TSF-L17	L17-2																				
TSF-L18	L18-1																				
TSF-L18	L18-2																				
TSF-L18	L18-3																				
TSF-L18	L18-4																				
TSF-L18	L18-5																				
TSF-L19	L19-1																				
TSF-L19	L19-2	3411	5564	11956	11956	25903	2153	25903	25171	4088	5509	1421	25171								
TSF-L20	L20-1																				
TSF-L20	L20-2	1681	2695	2695	2695	6014	1014	6014	5654	2014	2668	654	5654								
TSF-L20	L20-3	271	1609	1609	1609	6339	1339	6339	6269	324	1594	1269	6269								
TSF-L21	L21-1																				
TSF-L21	L21-2	837	819	2937	2937	2482	-18	2482	2308	1003	811	-192	2308								
TSF-L21	L21-3																				
TSF-L22	L22-1																				
TSF-L22	L22-2	11005	1004	2111	2111	-7501	-10001	-7501	-9696	13190	994	-12196	-9696								
TSF-L23	L23-1	969	1058	2044	2044	5089	89	5089	4886	1161	1048	-114	4886								
TSF-L24	L24-1																				
TSF-L24	L24-2	1782	1542	4518	4518	4760	-240	4760	4391	2136	1527	-609	4391								
TSF-L25	L25-1																				
TSF-L25	L25-2	559	347	1040	1040	618	-212	618	504	670	344	-326	504								
TSF-L26	L26-1																				
TSF-L26	L26-2	2800	1625	5630	5630	3825	-1175	3825	3253	3356	1609	-1747	3253								
TSF-L27	L27-1																				
TSF-L27	L27-2																				
TSF-L27	L27-3	1773	1132	2046	2046	690	-640	690	326	2125	1121	-1004	326								
TSF-L28	L28-1																				
TSF-L28	L28-2	583	732	2683	2683	5149	149	5149	5026	699	725	26	5026								
TSF-L29	L29-1	848	504	959	959	4656	-344	4656	4483	1017	499	-517	4483								
TSF-L30	L30-1																				
TSF-L30	L30-2	2282	897	2295	2295	1115	-1385	1115	653	2735	888	-1847	653								
TSF-L31	L31-1																				
TSF-L31	L31-2	947	1539	2978	2978	1922	592	1922	1718	1135	1524	388	1718								
TSF-L32	L32-1	2474	1960	5192	5192	4486	-514	4486	3975	2965	1940	-1025	3975								
TSF-L32	L32-2																				
TSF-L32	L32-3	3485	2861	3998	3998	4376	-624	4376	3657	4177	2833	-1343	3657								
TSF-L33	L33-1	2010	2910	5977	5977	5900	900	5900	5473	2409	2882	473	5473								

SUBSTATION	CKT	Primary Voltage (kV)	Existing installed Based on NEM Data (kW)	Approved DG [kW]	In process [kW]	Total DG (kW) on Primary -2014		Total DG kW on Primary -2016		Total DG kW on Primary -2020		Total DG kW on Primary -2030		Existing Primary Min Load (kVA)	Existing Primary Peak Load (kVA)
						Short Term	Mid Term	Short Term	Long Term	Short Term	Long Term	Short Term	Long Term		
TSF-L33	L33-2	12.47	270	10	0	278.17	318.0	384.4	460.7	213	540				
TSF-L33	L33-3	12.47	1384	205	0	1425.52	1805.7	2183.0	2616.4	1525	2700				
TSF-L34	L34-1	12.47	386	45	0	397.21	489.3	591.6	705.0	580	950				
TSF-L35	L35-1	12.47	1543	306	0	1590.09	2102.4	2541.6	3046.2	2647	4520				
TSF-L35	L35-2	12.47	116	9	0	119.83	143.0	172.9	207.2	87	200				
TSF-L36	L36-1	2.4	45	2	0	46.29	52.6	63.6	76.3	37	95				
TSF-L36	L36-2	2.4	26	100	0	26.82	143.2	173.1	207.5	191	324				
TSF-L37	L37-1	12.47	159	0	0	163.88	186.3	225.2	270.0	131	269				
TSF-L37	L37-2	12.47	81	6	0	83.00	98.4	119.0	142.6	105	478				
TSF-L38	L38-1	12.47	727	265	0	749.48	1128.7	1364.5	1635.5	1653	2800				
TSF-L38	L38-2	12.47	428	70	0	441.09	566.7	685.1	821.2	2181	3680				
TSF-L39	L39-1	12.47	291	47	0	299.83	383.8	463.9	556.0	1079	2038				
TSF-L39	L39-2	12.47	86	82	0	88.56	191.0	230.8	276.7	64	308				
TSF-L40	L40-1	12.47	78	24	0	80.59	116.5	140.8	168.8	181	266				
TSF-L40	L40-2	12.47	108	0	0	111.26	152.9	183.3	218.3	81	270				
TSF-L42	L42-1	12.47	36	0	0	36.88	41.9	50.7	60.7	168	450				
TSF-L42	L42-2	12.47	82	18	0	84.20	113.3	136.9	164.1	316	975				
TSF-L43	L43-1	12.47	1241	63	0	1278.53	1483.0	1792.8	2148.8	1505	2200				
TSF-L43	L43-2	12.47	83	26	0	85.36	123.3	149.1	178.7	1209	1920				
TSF-L44	L44-1	4.16	82	15	0	84.85	111.2	134.4	161.1	394	820				
TSF-L45	L45-1	12.47	70	48	0	72.55	135.0	163.2	195.6	319	631				
TSF-L45	L45-2	12.47	24	0	0	24.67	28.0	33.9	40.6	38	339				
TSF-L46	L46-1	12.47	475	6	0	489.55	556.6	672.9	806.5	500	680				
TSF-L46	L46-2	12.47	725	98	0	747.16	936.4	1132.1	1356.8	968	2970				
TSF-L47	L47-1	12.47	2975	39	0	3065.25	3485.0	4213.1	5049.6	696	1690				
TSF-L47	L47-2	12.47	543	468	0	559.38	1149.2	1389.2	1665.1	1530	3740				
TSF-L48	L48-1	2.4	89	0	0	91.53	104.1	125.8	150.8	161	316				
TSF-L49	L49-1	12.47	169	219	0	174.33	440.9	533.0	638.9	580	790				
TSF-L49	L49-2	12.47	117	19	0	120.36	154.0	186.2	223.2	1620	2600				
TSF-L49	L49-3	12.47	52	52	0	53.93	118.6	143.4	171.9	501	710				
TSF-L49	L49-4	12.47	249	386	0	256.33	721.2	871.8	1044.9	1063	2750				
TSF-L50	L50-1	12.47	1000	4	0	1030.32	1171.4	1416.1	1697.3	374	950				
TSF-L50	L50-2	12.47	53	28	0	54.30	92.0	111.2	133.3	240	540				
TSF-L51	L51-1	12.47	432	109	0	445.16	615.6	744.2	891.9	804	1950				
TSF-L51	L51-2	12.47	287	100	0	295.51	440.0	531.9	637.6	1980	3860				
TSF-L51	L51-3	13.8	328	89	0	337.80	473.4	572.3	685.9	1073	4129				
TSF-L52	L52-1	12.47	321	70	0	331.09	445.5	538.5	645.4	707	1716				
TSF-L53	L53-1	12.47	0	0	0	0.00	0.0	0.0	0.0	38	356				
TSF-L53	L53-2	12.47	93	22	0	95.64	130.8	158.1	189.5	98	250				
TSF-L54	L54-1	12.47	64	11	0	65.97	85.8	103.7	124.3	321	600				
TSF-L55	L55-1	12.47	251	20	0	259.01	308.8	373.3	447.4	301	410				
TSF-L55	L55-2	12.47	29	4	0	29.97	38.0	45.9	55.0	63	240				
TSF-L56	L56-1	2.4	48	23	0	49.95	81.5	98.5	118.1	439	635				
TSF-L57	L57-1	12.47	26	0	0	27.26	31.0	37.5	44.9	20	60				
TSF-L57	L57-2	12.47	543	148	0	559.32	785.4	949.5	1138.0	676	1180				
TSF-L58	L58-1	12.47	257	117	0	265.20	425.2	514.0	616.1	388	412				
TSF-L59	L59-1	12.47	704	73	0	725.33	883.7	1068.3	1280.4	1037	2380				
TSF-L59	L59-2	12.47	1014	254	0	1044.79	1441.6	1742.7	2088.8	1133	2620				
TSF-L60	L60-1	12.47	141	28	0	144.80	191.6	231.6	277.6	230	485				
TSF-L61	L61-1	12.47	318	37	0	327.80	403.5	487.8	584.7	732	1075				

SUBSTATION	CKT	Existing Sub						Existing Sub			Existing			2016 Short Term				
		Existing DG on Sub XFMR	Existing DG XFMR Rating	Existing Sub XFMR Min Load (kVA)	Existing Sub XFMR Peak Load (kVA)	Remaining DG kW to 100% Gross DML	Existing 50% Sub MVA	Existing 50% Sub XFMR Rating	Remaining DG to 50% Substation XFMR Rating (kW)	2016 DG on Sub XFMR	2016 Sub XFMR Min Load (kVA)	2016 Sub XFMR Peak Load (kVA)	2016 DML-DG	2016 DG on Sub XFMR	2016 Sub XFMR Min Load (kVA)	2016 Sub XFMR Peak Load (kVA)	2016 DML-DG	2016 Short Term Remaining DG to 50% Substation XFMR Rating (kW)
TSF-L33	L33-2	1704	1738	3240	3409	34.09	5.00	5034	2124	1721	3209	-402	4598					
TSF-L33	L33-3	397	580	950	182.53	182.53	5.00	5183	489	574	941	85	5085					
TSF-L34	L34-1	1710	2734	4720	1024.29	1024.29	5.00	6024	2245	2708	4675	463	5463					
TSF-L35	L35-1	73	228	419	154.51	154.51	1.25	1405	196	225	415	30	1280					
TSF-L36	L36-1	247	236	747	-11.23	-11.23	2.50	2489	285	233	740	-51	2449					
TSF-L37	L37-1	749	1653	2800	903.64	903.64	5.00	5904	1129	1638	2774	509	5509					
TSF-L38	L38-1	441	2181	3680	1739.49	1739.49	5.00	6739	567	2160	3645	1593	6593					
TSF-L39	L39-1	388	1143	2336	754.47	754.47	2.50	3254	575	1132	2314	557	3057					
TSF-L40	L40-1	81	181	266	100.85	100.85	1.50	1601	116	180	263	63	1563					
TSF-L41	L41-1	111	81	270	-30.56	-30.56	2.50	2469	127	80	267	-47	2453					
TSF-L42	L42-1	121	484	1425	362.73	362.73	2.50	2863	155	479	1411	324	2824					
TSF-L42	L42-2	0	0	0	0	0	0	0	0	0	0	0	0					
TSF-L43	L43-1	1364	2714	4120	1350.23	1350.23	5.00	6350	1606	2688	4081	1082	6082					
TSF-L43	L43-2	0	0	0	0	0	0	0	0	0	0	0	0					
TSF-L44	L44-1	85	394	820	309.05	309.05	1.50	1809	111	390	813	279	1779					
TSF-L45	L45-1	97	357	970	259.34	259.34	3.75	4009	163	353	961	190	3940					
TSF-L46	L46-1	1237	1467	3650	230.65	230.65	5.00	5231	1493	1453	3616	-40	4960					
TSF-L46	L46-2	3625	2226	5430	-1398.33	-1398.33	5.00	3602	4634	2205	5379	-2429	2571					
TSF-L47	L47-1	92	161	316	69.37	69.37	0.66	729	104	159	313	55	715					
TSF-L48	L48-1	295	2201	3390	1905.96	1905.96	5.00	6906	595	2180	3358	1585	6585					
TSF-L49	L49-1	310	1564	3460	1254.04	1254.04	5.00	6254	840	1550	3427	710	5710					
TSF-L49	L49-2	1085	615	1490	-470.02	-470.02	2.50	2030	1263	609	1476	-655	1845					
TSF-L50	L50-1	741	2784	5810	2042.97	2042.97	5.00	7043	1056	2757	5755	1702	6702					
TSF-L50	L50-2	338	1073	4129	734.83	734.83	7.50	8235	473	1062	4090	589	8089					
TSF-L51	L51-1	331	707	1716	375.91	375.91	5.00	5376	445	700	1699	255	5255					
TSF-L51	L51-2	96	136	606	40.36	40.36	0.75	790	131	135	600	4	754					
TSF-L51	L51-3	66	321	600	255.03	255.03	2.50	2755	86	318	594	232	2732					
TSF-L52	L52-1	289	364	650	0	0	0	0	347	361	644	0	2514					
TSF-L52	L52-2	0	0	0	75.12	75.12	2.50	2575	0	0	0	14	2514					
TSF-L53	L53-1	50	439	635	389.05	389.05	5.00	5389	81	435	629	353	5353					
TSF-L53	L53-2	587	696	1240	1240	1240	0	0	816	689	1228	0	3623					
TSF-L53	L53-3	0	0	0	108.95	108.95	3.75	3859	0	0	0	-127	3623					
TSF-L54	L54-1	265	388	412	122.48	122.48	1.50	1622	425	384	408	-41	1459					
TSF-L54	L54-2	1770	2170	5000	400.10	400.10	3.75	4150	2325	2150	4953	-176	3574					
TSF-L55	L55-1	145	230	485	85.60	85.60	2.50	2586	192	228	480	37	2537					
TSF-L55	L55-2	328	732	1075	404.20	404.20	2.00	2404	404	725	1065	322	2322					

Attachment H – List of Potential Mitigation Measures Table

Appendix H – List of Potential Mitigation Measures Table

This Page Intentionally Left Blank

Appendix H – List of Potential Mitigation Measures Table

Mitigation Measure		Applicable Adverse Condition														
		System			Substation / Circuit			Steady-State			Customer					
		Transient	Steady State	Transient	Transient	Ground Fault Over-Voltage	Protection Issues	Phase Imbalance	LTC Reverse Flow	LTC Cycling	Voltage Violations	Transformer Overload	Feeder Overload	Transient Over-Voltage (TOV)	Secondary Over-Voltage	Steady State Equipment Overload
Reset Existing Inverters	S							S	S							
Fixed PF Control																
Advanced Inverter Functionalities	M		S											S		
Frequency-Response																
Volt-VAR							M			M						S/M
Voltage-Watt										M						S/M
Active Power Control	S/M						S			S		M/L		S/M		S/M
Turning Off Inverters	M							M						S/M		S/M
Energy Storage	M															
Located on Feeder		M								M						
Located on Residential or Commercial Site		S								S				S		S
Non-export (Size Limits)			S													
Grounding Bank																
Circuit Direct Transfer Trip																
Customer Direct Transfer Switch																
Protection Upgrades																
Dynamic Load Shed Scheme	M															

Appendix H – List of Potential Mitigation Measures Table

Mitigation Measure	Applicable Adverse Condition														
	System		Substation / Circuit					Steady-State				Customer			
	Transient	Steady State	Transient	Ground Fault Over-Voltage	Protection Issues	Phase Imbalance	LTC Reverse Flow	LTC Cycling	Voltage Violations	Transformer Overload	Feeder Overload	Transient Over-Voltage (TOV)	Secondary Over-Voltage	Transformer Overload	Secondary Overload
Substation Short Switch			M									M			
Customer Surge Arresters												M			
Voltage Control						L		S							
							S								
									S						
Equipment Upgrades								S						S	
															S
														M	
														M	
															S

Appendix H – List of Potential Mitigation Measures Table

Mitigation Measure	Applicable Adverse Condition																
	System			Substation / Circuit						Customer							
	Steady State		Transient Over-Voltage (T/OV)	Steady-State		Voltage Issues				Equipment Overload			Steady State				
	Transient	Excess Energy		Ground Fault Over-Voltage	Phase Imbalance	LTC Reverse Flow	LTC Cycling	Voltage Violations	Transformer Overload	Feeder Overload	Transient Over-Voltage (T/OV)	Secondary Over-Voltage	Transformer Overload	Secondary Overload			
Adding Distribution Customer Transformer & Splitting Load																	
Capacitor Relocations																	
Demand Response - Turning On / Off Equipment	M	M								M							
	M	M								M							
	M	M								M							

This Page Intentionally Left Blank